

Contents of Box 1 - P/N 6508115

1628mm x 273mm x 512mm (64.09" x 10.74" x 20.15") - 78.23 lbs.

1 – Owner's manual

2 – Instructions

3 – Shocks x 2 (l)

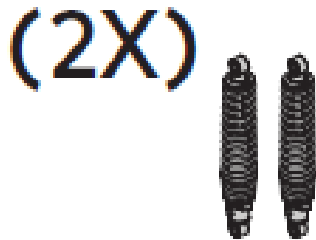

4 – Front crossmember (e)

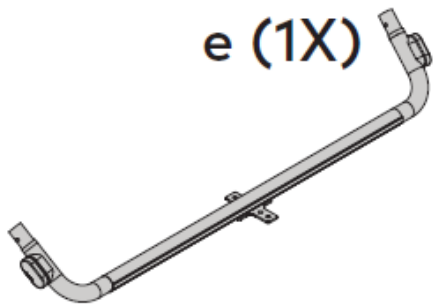

5 – Middle crossmember (c)

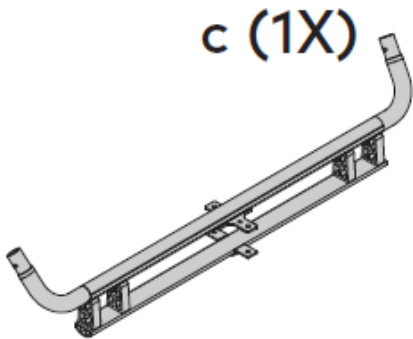

6 – Trailing arms x 2 (j)

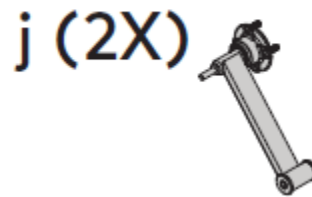

7 – Left fender (f)

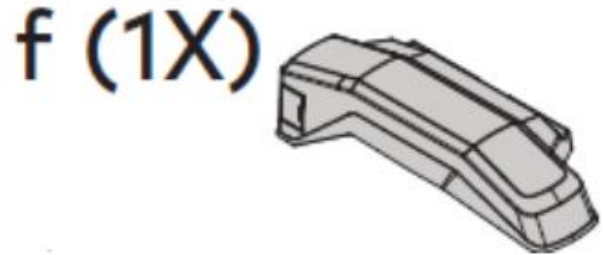

8 – Right Fender (g)

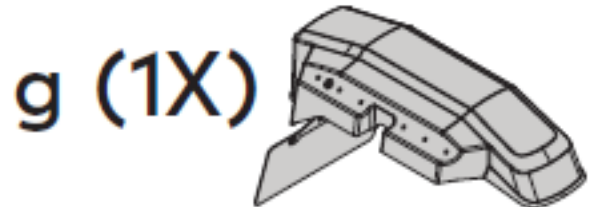

9 – Hardware pack #1 (see page 4 for details)

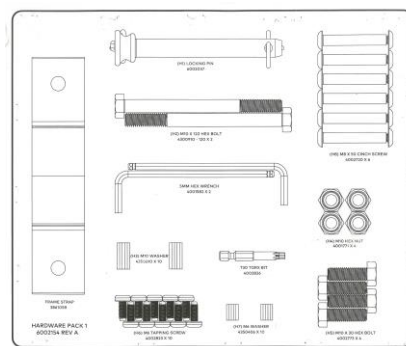

Contents of Box 2 – P/N 6508116

Contains VIN – 86.61 lbs.

2024mm x 372 mm x 218mm (79.68" x 14.64" x 8.58")

1 – Spine end piece (aluminum) (b)

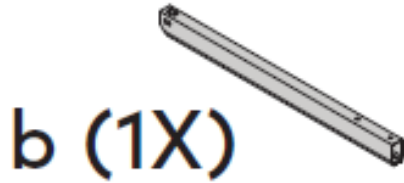

4 – Kickstand (k)

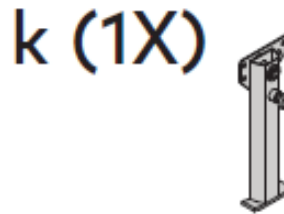

2 – Crossbars x 2



5 – Hardware pack #2 (see page 5 for details)

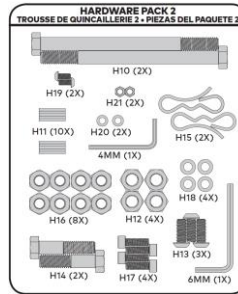

3 – EasyRider Crossbar Brackets x 4 (n)

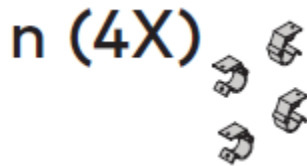

6 – Spine/Tongue Assembly w/ coupler & chains (a)

3 – Rear crossmember (d)

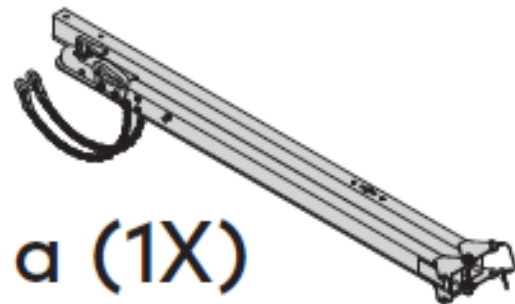
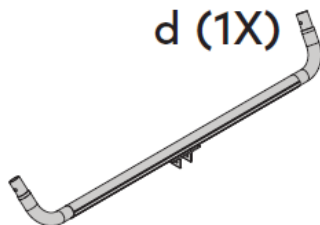

Contents of Box 3 P/N 6508117

2209mm x 475mm x 66mm (86.96" x 18.70" x 2.59")
17.73 lbs

Driver's Side Frame (i)

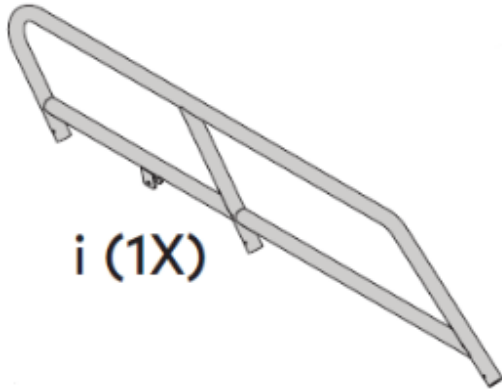

i (1X)

Contents of Box 4 P/N 6508118

2209mm x 475mm x 66mm (86.96" x 18.70" x 2.59")
17.73 lbs.

Passenger Side Frame (h)

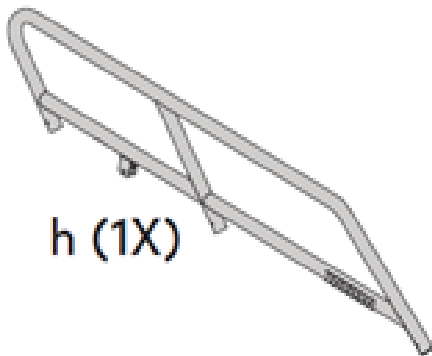

h (1X)

Contents of Box 5 P/N 6508119

540mm x 540mm x 295 mm (21.25" x 21.25" x 11.61")
38.93 lbs.

Tires x 2 – Yakima logo hub covers pre-installed
(check PSI) (m)

m (2X)



Contents of Hardware Pack #1

1 x Pivot pull pin & lanyard (H1)

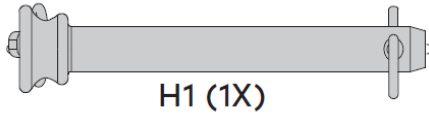

2 x Frame bolts – M10-120 (H2)

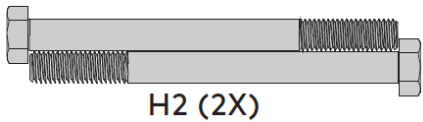

6 x Architect Frame bolts – 8x49 (H8)

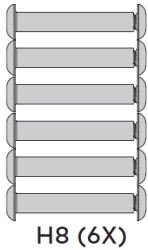

2 x 5mm allen wrench

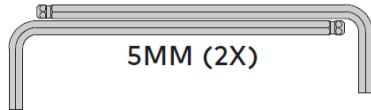

10 x washers – M6 (H7)



1 x T30 Torx bit

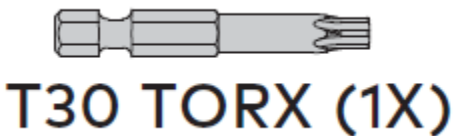

4 x Hex nuts – M10-1.5, Nyloc (H4)

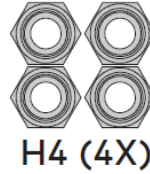

4 x Hex bolts – M10x30 (H5)

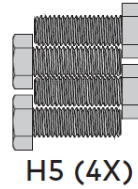

10 x Fender bolts – Tapping screw, M6x15, conductive (H6)

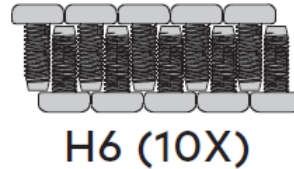

10 x Fender washers – M10 (H3)



1 x Underside bracket, curved (H22)



Contents of Hardware Pack #2

2 x Suspension bolts – M14x190 (H10)

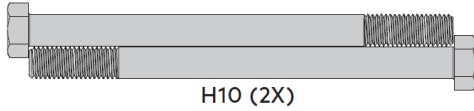

2 x Shock pins (H15)

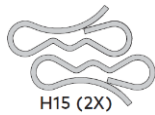

8 x Lug nuts – M12 (H16)

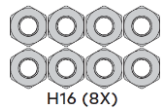

4 x Shock hex nuts - M14 (H12)

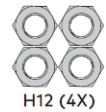

4 x Shock washers – M8 (H18)

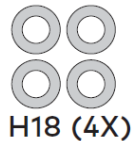

10 x Washers, suspension – M14 (H11)

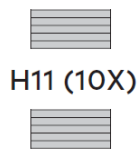

3 x Kickstand hardware bolts – M10-1.5x25 (H13)

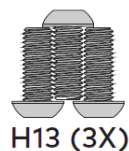

1 x 6mm allen wrench



2 x Shock bolts (upper) - M14x190 (H14)

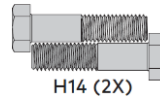

4 x Crossbar tower screws – M8-1.25x25 (H17)

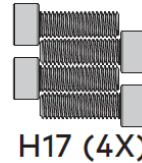

In pack #2, license plate hardware:

2 x bolts – M6-1x13 (H19)

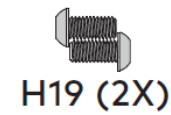

2 x washers - M6 (H20)

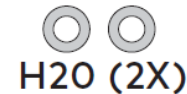

2 x nuts – M6x1 Nyloc (H21)

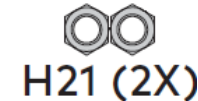

1 x 4mm allen wrench

