

YAKIMA

SkyBox

US

NO PRE-ASSEMBLY REQUIRED

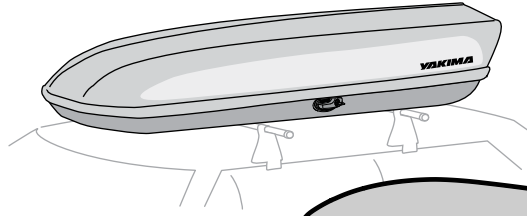

SKYBOX (1X)

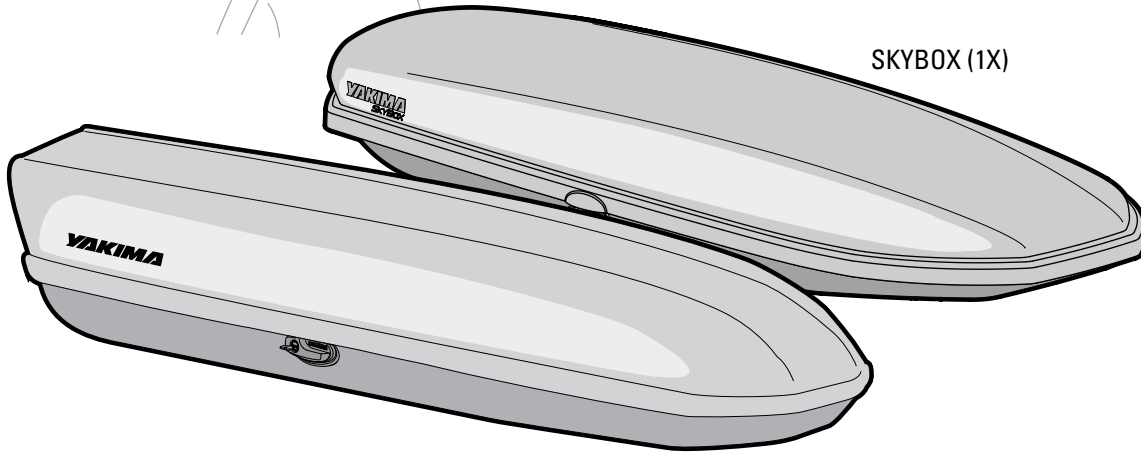

You may need a measuring tape or ruler.



TO VERIFY THIS PRODUCT'S COMPATIBILITY WITH YOUR VEHICLE, GO ONLINE TO WWW.YAKIMA.COM, OR CALL (888) 925-4621.

MAXIMUM LOAD LIMITS:

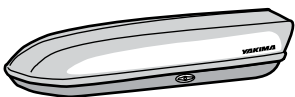

box weight



rack weight
(if appropriate)

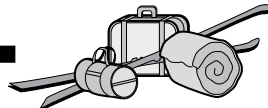

box contents



**DO NOT EXCEED
YOUR RACK'S
WEIGHT LIMIT!**

SkyBox 12.....	41 lbs. / 19 kg
SkyBox 16.....	47 lbs. / 21 kg
SkyBox 18.....	52 lbs. / 24 kg
SkyBox Lo.....	52 lbs. / 24 kg
SkyBox 21.....	62 lbs. / 28 kg

Check with your YAKIMA dealer or visit "Choose my Rack" at yakima.com for your vehicle's load limits.

IMPORTANT WARNING!

IT IS CRITICAL THAT ALL YAKIMA RACKS AND ACCESSORIES BE PROPERLY AND SECURELY ATTACHED TO YOUR VEHICLE. IMPROPER ATTACHMENT COULD RESULT IN AN AUTOMOBILE ACCIDENT, AND COULD CAUSE SERIOUS BODILY INJURY OR DEATH TO YOU OR TO OTHERS. YOU ARE RESPONSIBLE FOR SECURING THE RACKS AND ACCESSORIES TO YOUR CAR, CHECKING THE ATTACHMENTS PRIOR TO USE, AND PERIODICALLY INSPECTING THE PRODUCTS FOR ADJUSTMENT, WEAR, AND DAMAGE. THEREFORE, YOU MUST READ AND UNDERSTAND ALL OF THE INSTRUCTIONS AND CAUTIONS SUPPLIED WITH YOUR YAKIMA PRODUCT PRIOR TO INSTALLATION OR USE. IF YOU DO NOT UNDERSTAND ALL OF THE INSTRUCTIONS AND CAUTIONS, OR IF YOU HAVE NO MECHANICAL EXPERIENCE AND ARE NOT THOROUGHLY FAMILIAR WITH THE INSTALLATION PROCEDURES, YOU SHOULD HAVE THE PRODUCT INSTALLED BY A PROFESSIONAL INSTALLER.

Part #1034839 Rev.A

1

OPEN GEAR BOX.

- Insert key. Turn counter clock-wise to unlock.
- Rotate handle (handle will not rotate if box is locked).
- Lift to open.

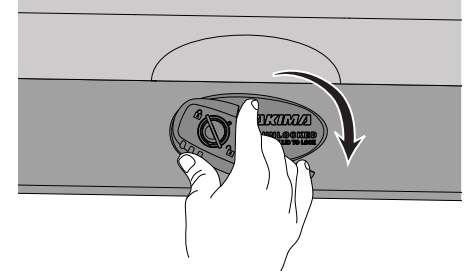
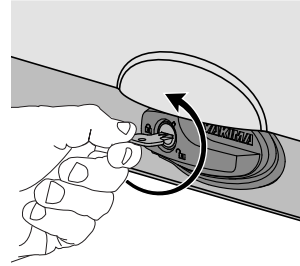

2

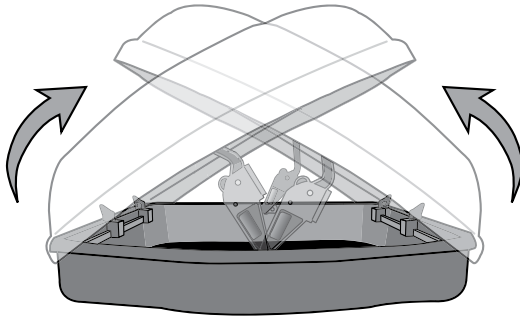
 Lid will open both ways for ease of installation.

- Latches must be engaged before opening other side.
- Box should only be opened one side at a time.

INSIDE THE BOX:

3

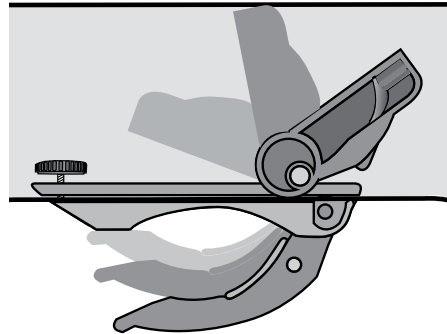
 Open levers all the way to lower clamps.

4

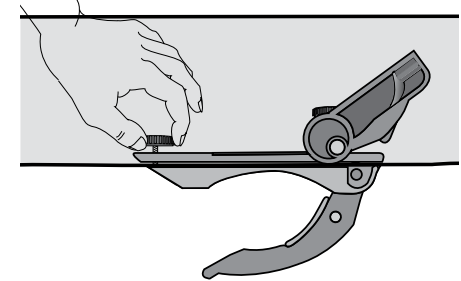
 Loosen track thumb wheel 1/2 turn. Do not remove wheel.

REMOVING THUMBWHEELS WILL CAUSE DISASSEMBLY OF LEVER/CLAMP MECHANISM.

LOAD CARGO BOX ONTO VEHICLE:



If your vehicle has a fairing, you must remove it if there is any interference.

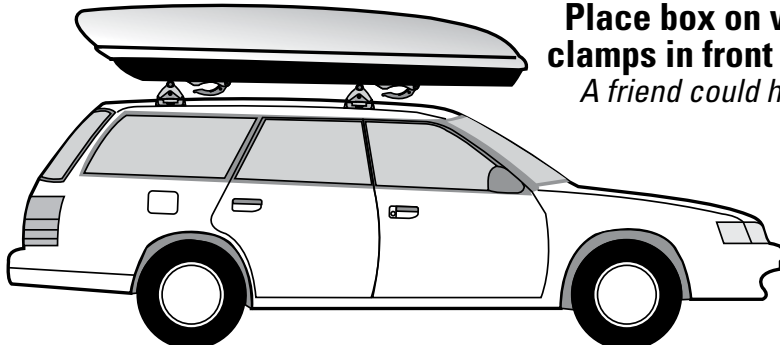

5

Place box on vehicle with clamps in front of crossbars.
A friend could help with this.

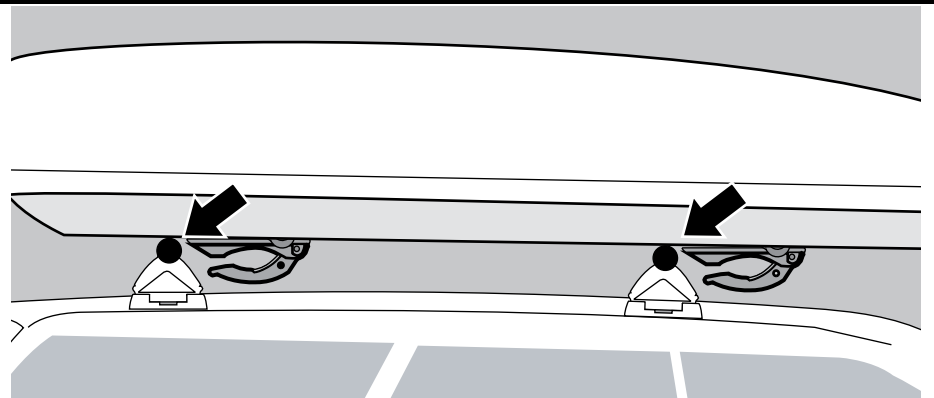

6 Open lid to gain access to levers.

Slide clamps along tracks (inside box) to engage crossbars.

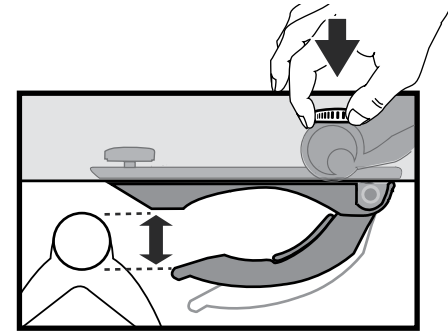
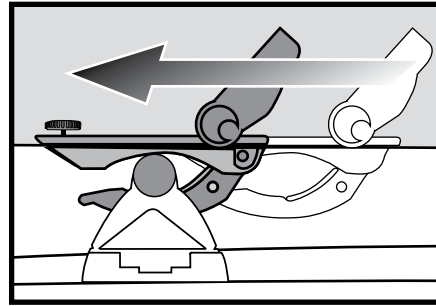
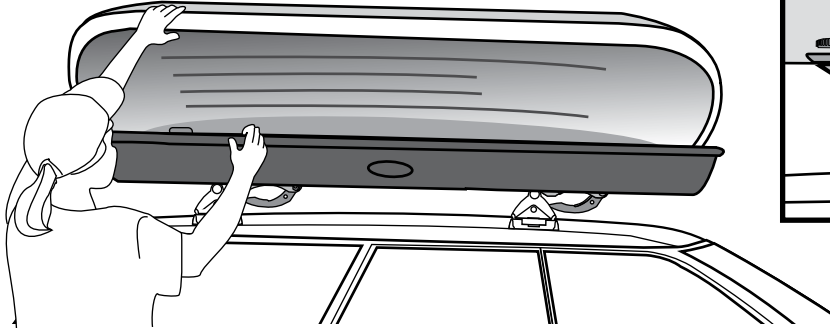

- Check clamp opening for crossbar clearance.
- Loosen clamp thumb wheel if necessary.

7 Adjust box position, checking for good alignment.

Always position box to avoid interference with rear hatch or sunroof.

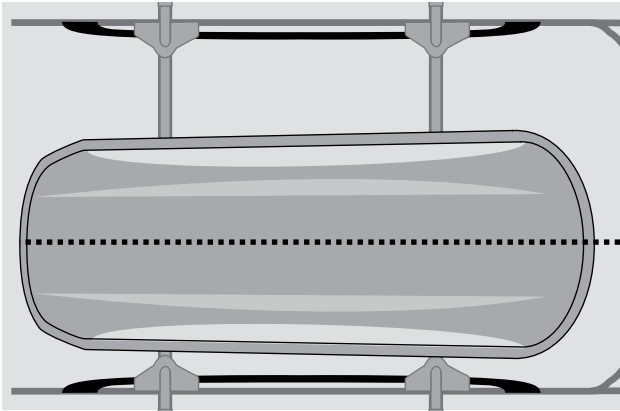

On some vehicles, hatch interference is unavoidable. Use caution when opening your hatch.



8

Close levers to engage clamps.

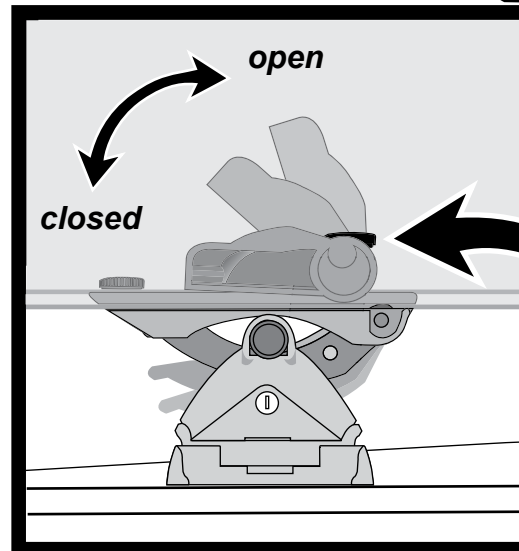

Tighten clamp thumb wheels until the levers close with firm resistance.

9

TIGHTEN ALL THUMB WHEELS.

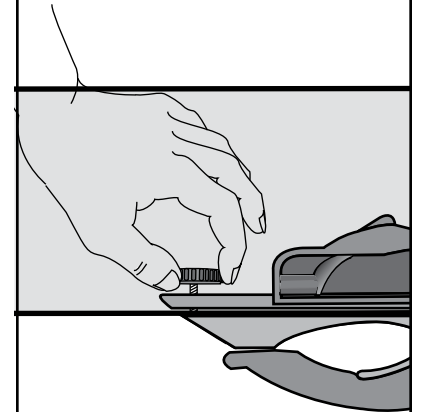

10 Close the box...

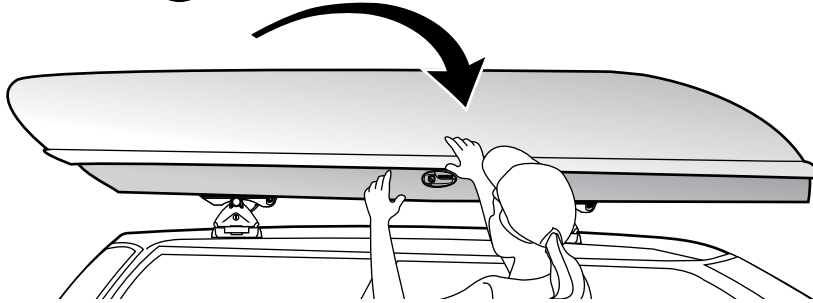

Push the lid down until the handle returns to a horizontal position.



Handle must return to the horizontal position to lock box and remove key.

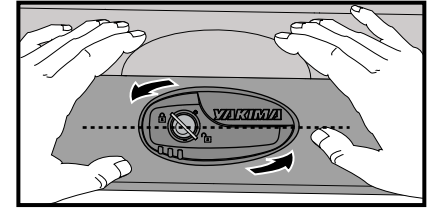
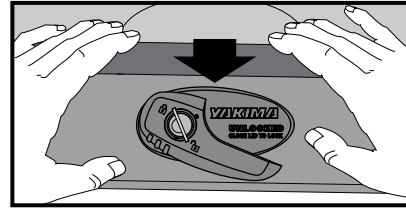

11 CHECK THE CLOSURE—PUSH UP ON LID.

**Check that box is closed by
LIFTING UP AT BOTH ENDS.**

CAUTION:
*Overstuffing the box
may prevent a secure closure.*

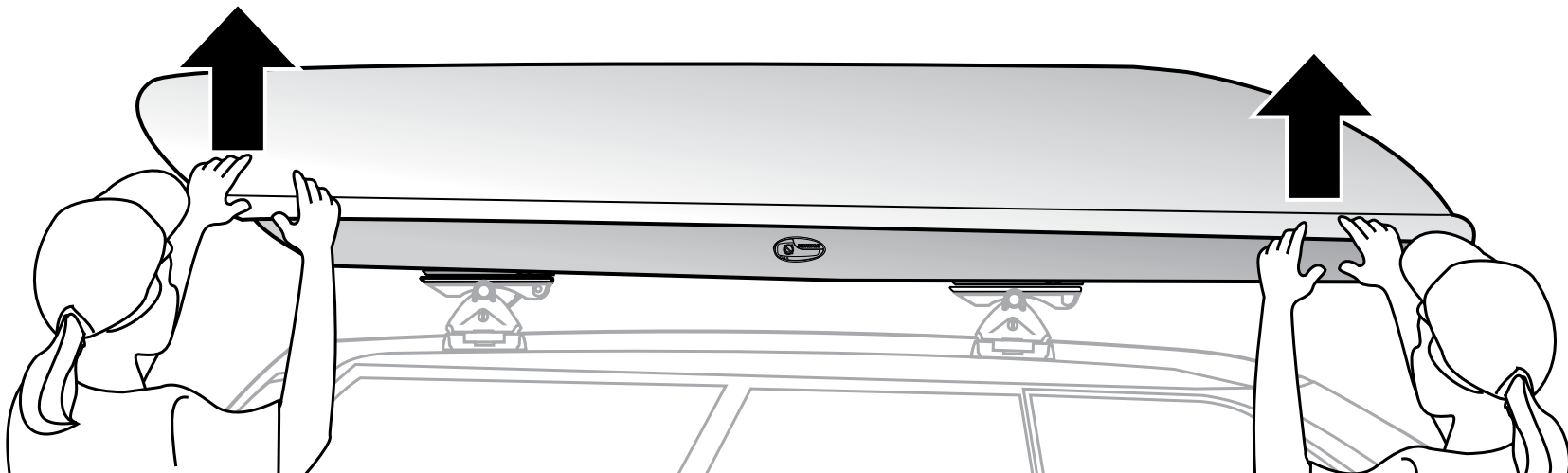

13 CHECK INSTALLATION BEFORE DRIVING AWAY

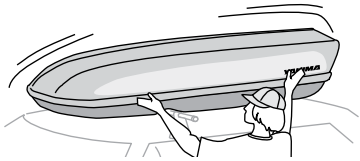

Make sure installation is secure by tugging at box.

- The box should not slide on the bars.
- Open the box and tighten levers if necessary.

CENTER HEAVIER LOADS IN THE CENTER OF THE BOX.

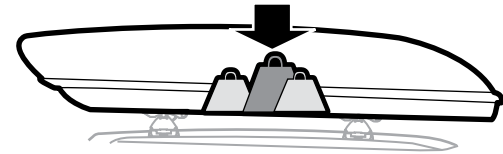

ALWAYS SECURE THE LOAD INSIDE THE BOX.

Use tie-down locations in rails.

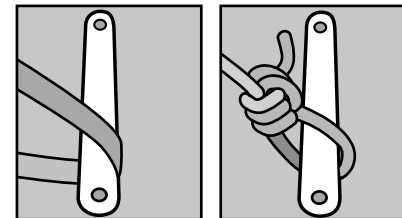

To lock...

- Turn key clockwise.
- To unlock, insert key and turn key counterclockwise.

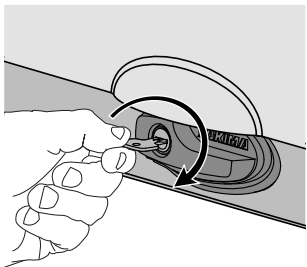

NOTE: Box must be closed and handle in horizontal position in order to lock box and remove key.

To replace lock core...

- Close box.
- Insert key and turn it to 45° counter clockwise. Remove key.

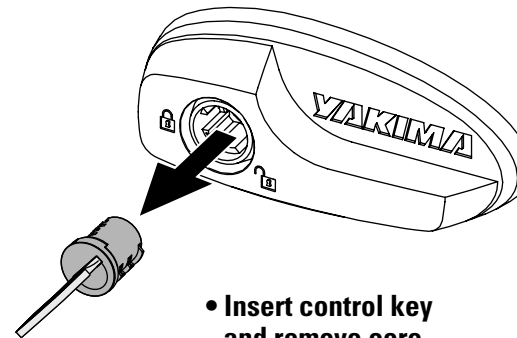
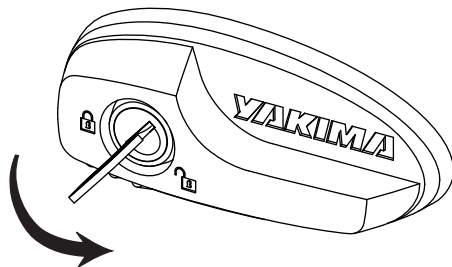

- Insert control key and remove core with control key.

- Install new lock core. Follow instructions that came with your lock core purchase.

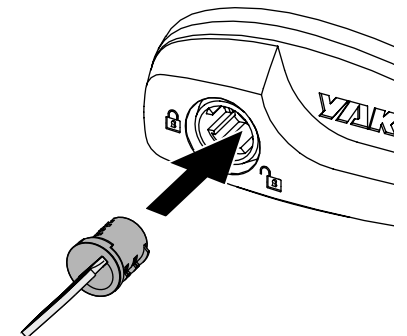

TO REMOVE CARGO BOX:

- Do not remove or adjust thumb wheels.
- Simply raise levers and remove box from crossbars.

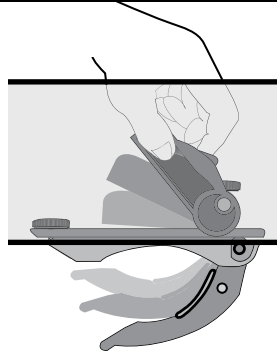

TO REINSTALL:

- With gear box adjusted to your vehicle, simply reload onto car, close levers and check for tightness.



To retain the adjustments for your vehicle, leave thumb wheels tightened.

REMOVING THUMBWHEELS WILL CAUSE DISASSEMBLY OF LEVER/CLAMP MECHANISM.

CARE AND MAINTENANCE

YAKIMA cargo boxes should be cared for and maintained, especially in extreme weather conditions.

- To clean, use only mild detergents. Harsh detergents could damage the gear box surface.
- Protect your gear box from extreme temperatures, (heat or cold) during prolonged storage.
- Remove gear box before entering automatic car wash.
- Hardware such as locks should be lubricated with graphite or other dry lubricant.

CAUTION

IF YOUR VEHICLE HAS A REAR HATCH:

On some vehicles, hatch interference is unavoidable.

Use caution when opening your hatch.

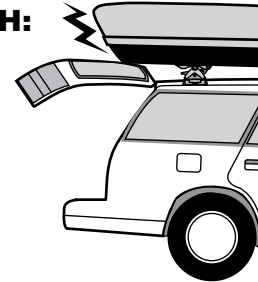

If your vehicle has a fairing, you must remove it if there is any interference.

READ THESE WARNINGS!

Periodically check the levers inside the box and tighten if necessary.

ATTACHMENT HARDWARE CAN LOOSEN OVER TIME. CHECK AND TIGHTEN IF NECESSARY, BEFORE EACH USE.

BE SURE ALL HARDWARE IS SECURED ACCORDING TO INSTRUCTIONS. FAILURE TO PERFORM SAFETY CHECKS BEFORE DRIVING AWAY CAN RESULT IN PROPERTY DAMAGE, PERSONAL INJURY, OR DEATH.

KEEP THESE INSTRUCTIONS

IF YOU NEED FURTHER TECHNICAL ASSISTANCE OR REPLACEMENT PARTS: Please contact your dealer or call us at (888) 925-4621 Monday through Friday, 7:00 A.M. to 5:00 P.M. PST.



This product is covered by YAKIMA's "Love It Till You Leave It" Limited Lifetime Warranty

To obtain a copy of this warranty, go online to www.yakima.com or email us at yakwarranty@yakima.com or call (888) 925-4621

YAKIMA

SkyBox

FR

NE NÉCESSITE PAS D'ASSEMBLAGE PRÉALABLE

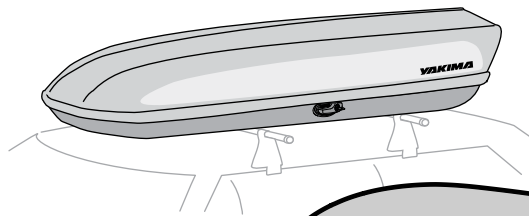

SKYBOX (X 1)

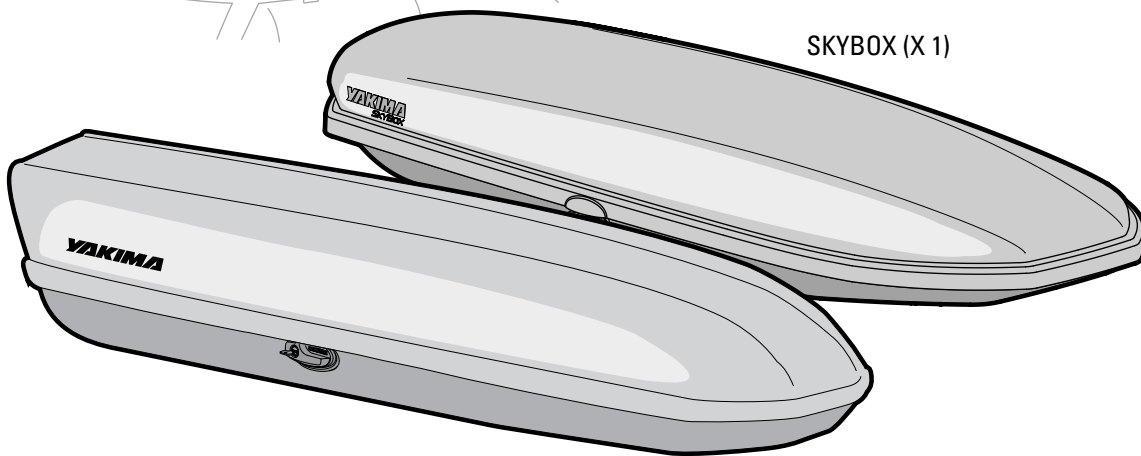

Il faudra peut-être un ruban à mesurer ou une règle.



POUR VÉRIFIER LA COMPATIBILITÉ DE CE PRODUIT AVEC LE VÉHICULE, CONSULTER LE SITE WWW.YAKIMA.COM, OU APPELER AU (888) 925-4621.

CHARGE MAXIMALE:



charge de la caisse

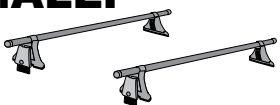

poids du porte-bagages (le cas échéant)

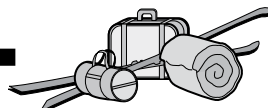

contenu de la caisse



NE PAS DÉPASSER LA LIMITE DE CHARGE DU PORTE-BAGAGES!

Pour connaître la limite de charge du véhicule, consulter le dépositaire Yakima ou, sur internet, la section "Choose my Rack" de notre site yakima.com.

SkyBox 12.....	41 lbs. / 19 kg
SkyBox 16.....	47 lbs. / 21 kg
SkyBox 18.....	52 lbs. / 24 kg
SkyBox Lo.....	52 lbs. / 24 kg
SkyBox 21.....	62 lbs. / 28 kg

AVERTISSEMENT IMPORTANT:

IL EST IMPÉRATIF QUE LES PORTE-BAGAGES ET LES ACCESSOIRES YAKIMA SOIENT CORRECTEMENT ET SOLIDEMENT FIXÉS AU VÉHICULE. UN MONTAGE MAL RÉALISÉ POURRAIT PROVOQUER UN ACCIDENT D'AUTOMOBILE, QUI POURRAIT ENTRAÎNER DES BLESSURES GRAVES OU MÊME LA MORT, À VOUS OU À D'AUTRES PERSONNES. VOUS ÊTES RESPONSABLE DE L'INSTALLATION DU PORTE-BAGAGES ET DES ACCESSOIRES SUR VOTRE VÉHICULE, D'EN VÉRIFIER LA SOLIDITÉ AVANT DE PRENDRE LA ROUTE ET DE LES INSPECTER RÉGULIÈREMENT POUR EN CONTRÔLER L'ÉTAT, L'AJUSTEMENT ET L'USURE. VOUS DEVEZ DONC LIRE ATTENTIVEMENT TOUTES LES INSTRUCTIONS ET TOUS LES AVERTISSEMENTS ACCOMPAGNANT VOTRE PRODUIT YAKIMA AVANT DE L'INSTALLER ET DE L'UTILISER. SI VOUS NE COMPRENEZ PAS TOUTES LES INSTRUCTIONS ET TOUS LES AVERTISSEMENTS, OU SI VOUS N'AVEZ PAS DE COMPÉTENCES EN MÉCANIQUE ET NE COMPRENEZ PAS PARFAITEMENT LA MÉTHODE DE MONTAGE, VOUS DEVRIEZ FAIRE INSTALLER LE PRODUIT PAR UN PROFESSIONNEL, COMME UN MÉCANICIEN OU UN CARROSSIER COMPÉTENT.

1

OUVRIR LA CAISSE.

- Insérer la clé. La tourner vers la gauche pour déverrouiller.
- Tourner le bouton (le bouton ne tourne pas si la caisse est verrouillée).
- Soulever le couvercle.

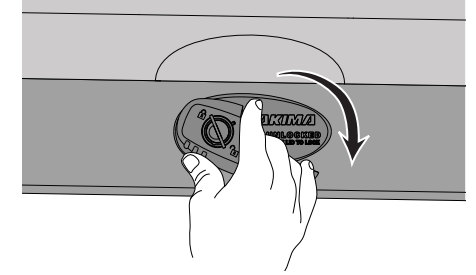
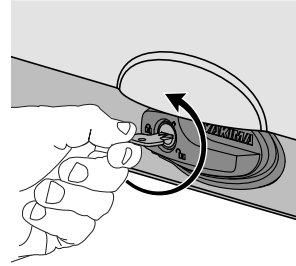

2

Le couvercle s'ouvre dans les deux sens pour faciliter le montage.

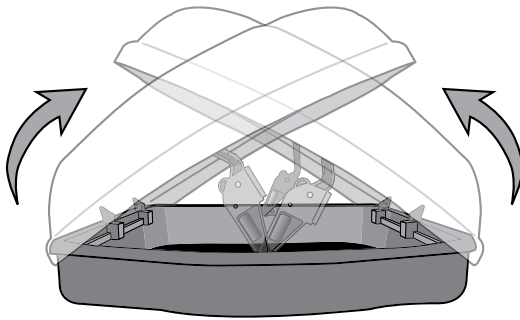

- Les loquets doivent être fermés avant d'ouvrir la caisse de l'autre côté.
- N'ouvrir la caisse que par un côté à la fois.

À L'INTÉRIEUR DE LA CAISSE:

3

Basculer les leviers complètement pour abaisser les pinces.

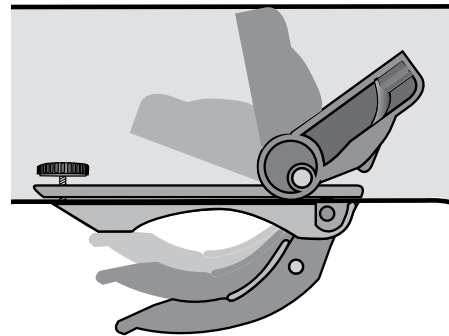

4

Desserrer la molette de la glissière de 1/2 tour. Ne pas enlever la molette.

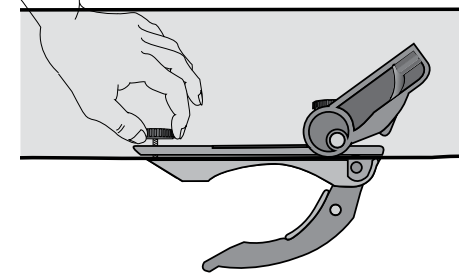

SI L'ON ENLÈVE LES MOLETTES, ON SE TROUVERA À DÉMONTÉ LE MÉCANISME DE FERMETURE DES PINCES.

CHARGER LA CAISSE SUR LE VÉHICULE:



Si le véhicule a un déflecteur, il faut l'enlever si le déflecteur touche à la caisse.

5

Déposer la caisse sur le véhicule, en plaçant les pinces à l'avant des barres transversales. Cette opération est plus facile à deux personnes.

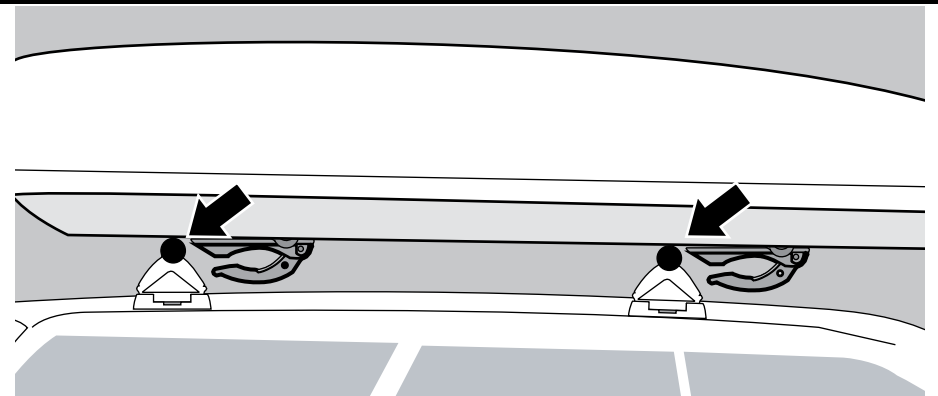

6 OUVRIR LE COUVERCLE POUR POUVOIR ATTEINDRE LES LEVIERS.

Faire coulisser les pinces le long de leur glissière (à l'intérieur de la caisse) pour qu'elles s'engagent sur les barres transversales.

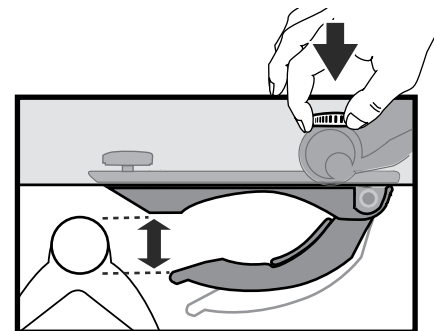
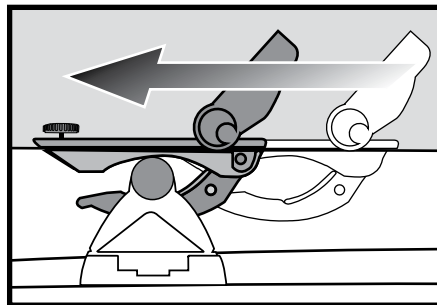
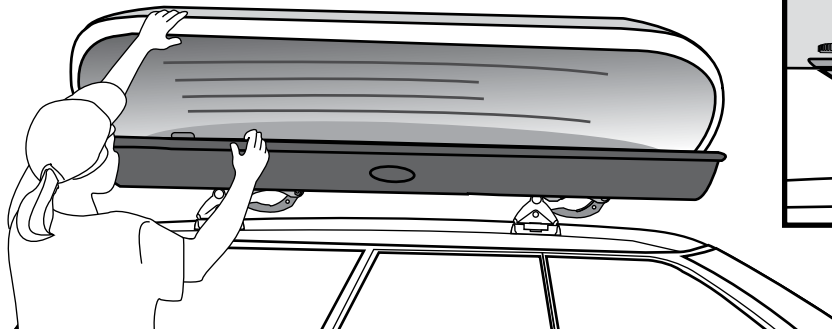

- Vérifier que les pinces sont suffisamment ouvertes pour accepter les barres.
- Desserrer les molettes des leviers au besoin.

7 Régler la position de la caisse pour qu'elle soit bien alignée.

Toujours positionner la caisse de manière qu'elle ne gêne pas l'ouverture du hayon ou du toit ouvrant.

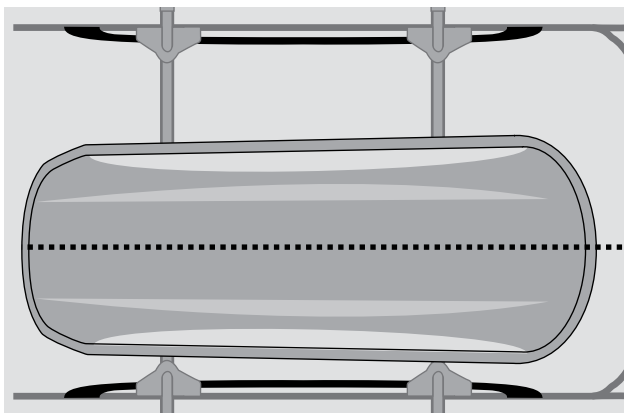

Sur certains véhicules, il est inévitable que le hayon touche à la caisse. Faire attention en ouvrant le hayon.



8

Rabattre les leviers pour fermer les pinces.

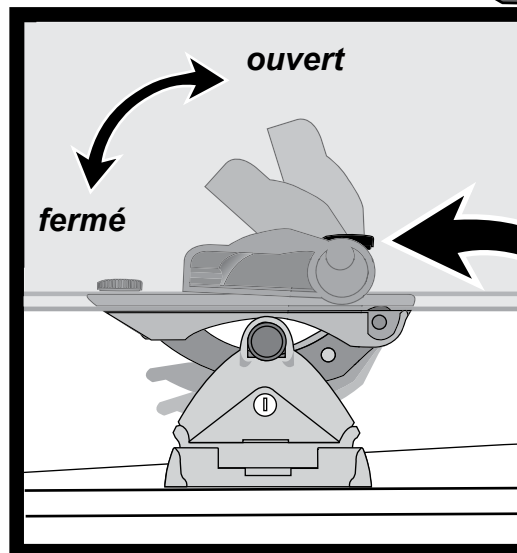

Serrer les molettes des leviers jusqu'à ce que les leviers se rabattent avec une bonne résistance.

9

SERRER TOUTES LES MOLETTES.

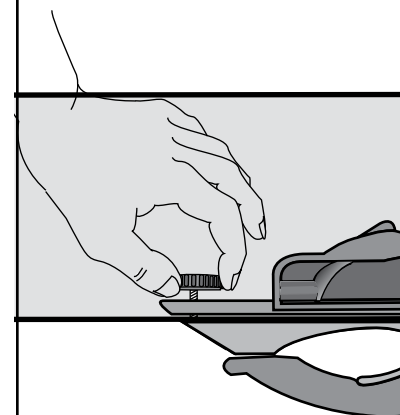

10 FERMER LA CAISSE...

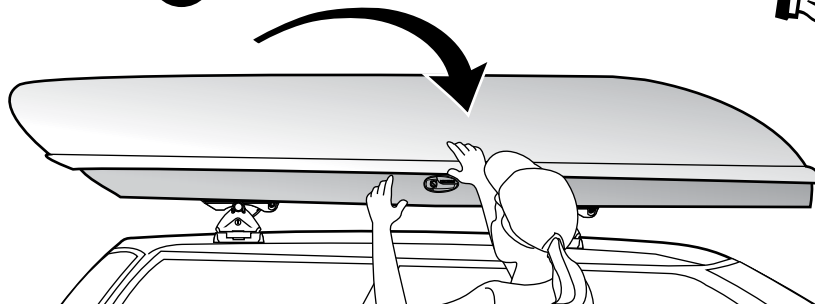

Rabattre le couvercle jusqu'à ce que le bouton revienne à l'horizontale.

Le bouton doit obligatoirement revenir à l'horizontale pour que la caisse soit fermée et qu'on puisse enlever la clé.

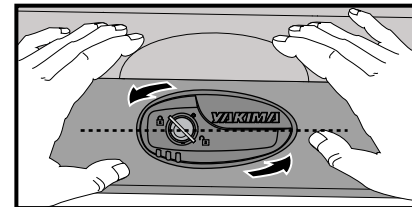
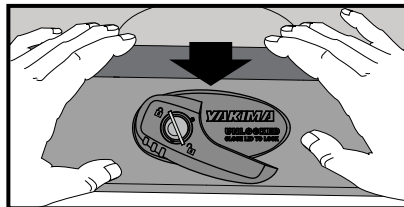

11

VÉRIFIER LA FERMETURE—
ESSAYER DE SOULEVER LE COUVERCLE.
Vérifier que la caisse est bien fermée EN
TENTANT DE L'OUVRIR AUX DEUX BOUTS!

ATTENTION:

*Si l'on remplit trop la caisse, elle
risque de ne pas bien fermer.*

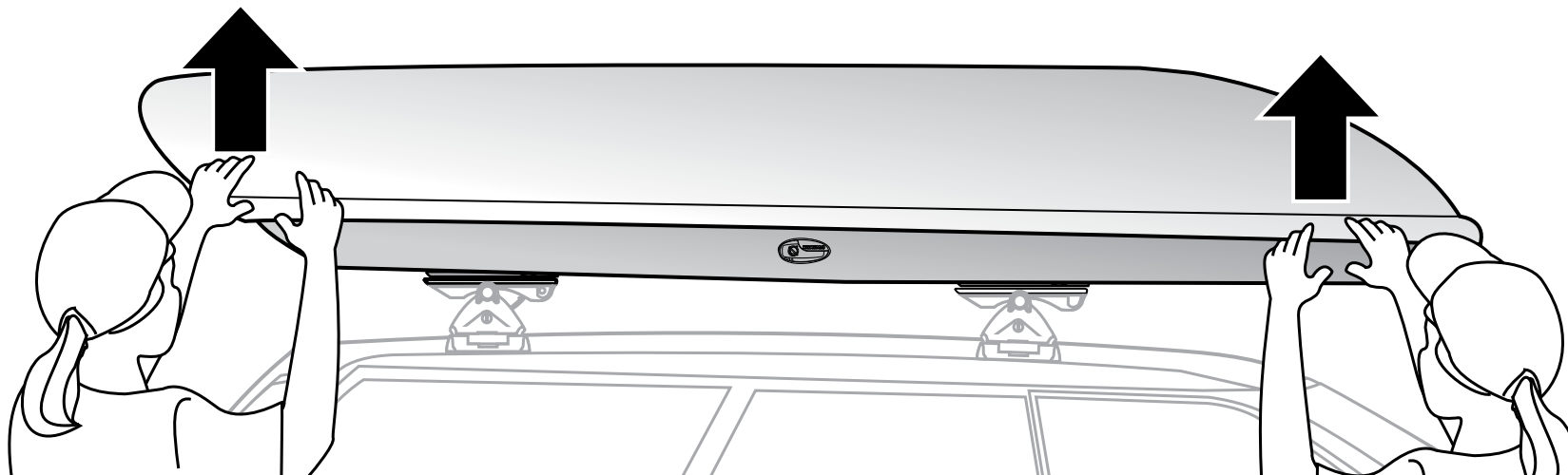

13 VÉRIFIER LE MONTAGE AVANT DE PRENDRE LA ROUTE

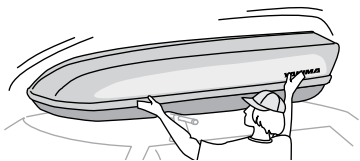

S'assurer que le montage est solide en secouant la caisse.

- La caisse ne doit pas glisser sur les barres.
- Ouvrir la caisse et resserrer les leviers au besoin.

CENTERER LES CHARGES LES PLUS LOURDES DANS LE CENTRE DE LA CAISSE.

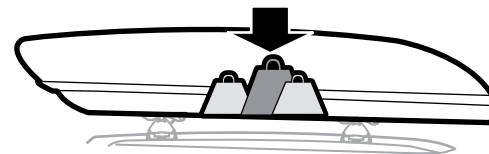

TOUJOURS ARRIMER LA CHARGE À L'INTÉRIEUR DE LA CAISSE.

Employer les points d'arrimage aménagés dans les longerons.

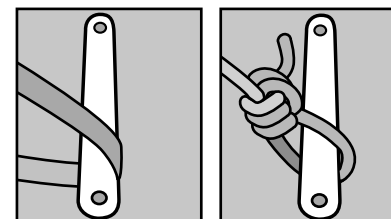

Pour verrouiller...

- Tourner la clé à droite.
- Pour déverrouiller, insérer la clé et la tourner vers la gauche. counterclockwise.

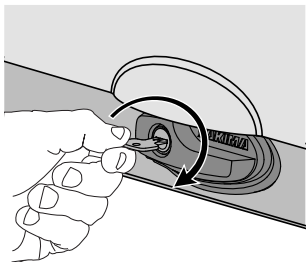

REMARQUE : la caisse doit être fermée et le bouton à l'horizontale pour qu'on puisse verrouiller la caisse et retirer la clé.

Pour remplacer le barillet de la serrure...

- Fermer la caisse.

- Insérer la clé et la tourner de 45° vers la gauche. Enlever la clé.

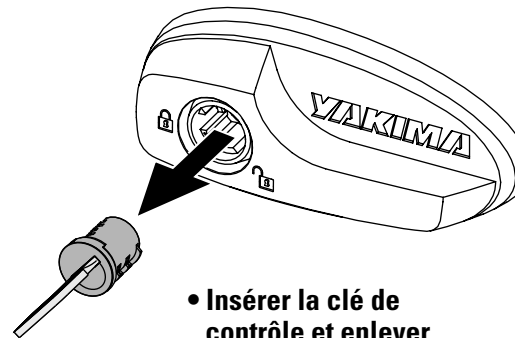
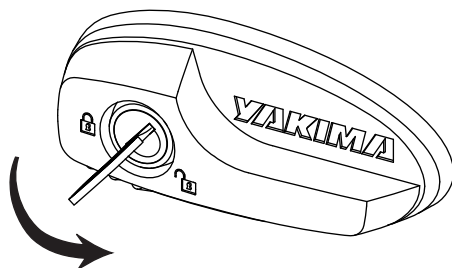

- Insérer la clé de contrôle et enlever la serrure avec la clé de contrôle.

- Insérer la nouvelle serrure en suivant les instructions qui l'accompagnent.

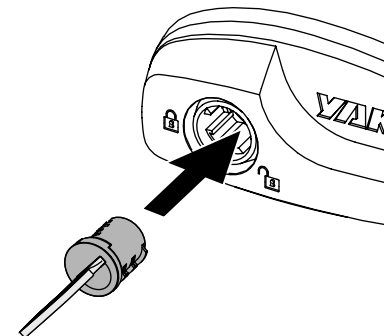

POUR ENLEVER LA CAISSE:

- Ne pas enlever ou dérégler les molettes.
- Il suffit de soulever les leviers et d'enlever la caisse des barres transversales.

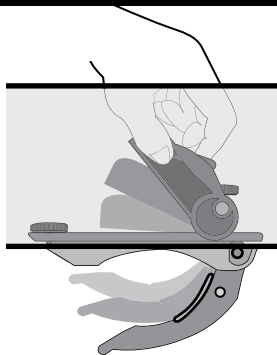

Pour conserver les réglages correspondant au véhicule, laisser les molettes serrées.

SI L'ON ENLÈVE LES MOLETTES, ON SE TROUVERA À DÉMONTÉ LE MÉCANISME DE FERMETURE DES PINCES.

POUR RÉINSTALLER:

- Avec la caisse réglée au véhicule, pour la réinstaller il suffit de la déposer sur le véhicule, de rabattre les leviers et de vérifier que tout est bien serré.

ENTRETIEN

Il faut prendre soin des caisses à bagages Série Pro et les entretenir, en particulier si les conditions météo sont très rigoureuses.

- Pour le nettoyage, n'employer que des savons doux. Les détergents agressifs pourraient endommager le fini de la caisse.
- Protéger la caisse des extrêmes de froid ou de chaleur quand elle est entreposée longtemps.
- Enlever la caisse avant de passer dans un lave-auto automatique.
- Lubrifier les pièces, comme les serrures, avec un lubrifiant sec (du graphite, par exemple).

ATTENTION

SI LE VÉHICULE A UN HAYON:

Sur certains véhicules, il est inévitable que le hayon touche à la caisse.

Faire attention en ouvrant le hayon.



Si le véhicule a un déflecteur, il faut l'enlever si le déflecteur touche à la caisse.

LIRE CES AVERTISSEMENTS!

Vérifier régulièrement les leviers à l'intérieur de la caisse et les resserrer au besoin.

LES DISPOSITIFS DE FIXATION PEUVENT SE DESSERRER À LA LONGUE. LES INSPECTER ET LES RESSERRER AU BESOIN, ET AVANT CHAQUE UTILISATION.

S'ASSURER QUE LE MONTAGE EST SOLIDE ET CONFORME AUX INSTRUCTIONS. SI L'ON N'EFFECTUE PAS LES VÉRIFICATIONS DE SÉCURITÉ AVANT DE PRENDRE LA ROUTE, ON RISQUE DE PROVOQUER DES DOMMAGES, DES BLESSURES OU MÊME LA MORT.

CONSERVER CES INSTRUCTIONS!

SI VOUS AVEZ BESOIN DE RENSEIGNEMENTS TECHNIQUES COMPLÉMENTAIRES OU DE PIÈCES DE RECHANGE: prière de contacter votre dépositaire ou appelez-nous au (888) 925-4621 du lundi au vendredi, entre 7 heures et 17 heures, heure du Pacifique.



Ce produit est couvert par la garantie limitée « Tant que durera notre histoire d'amour » YAKIMA

Pour se procurer une copie de cette garantie, aller en ligne à www.yakima.com <<http://www.yakima.com>> ou nous envoyer un courriel à yakwarranty@yakima.com <<mailto:yakwarranty@yakima.com>> ou appeler au (888) 925-4621

YAKIMA

SkyBox

ES

NO REQUIERE MONTAJE PREVIO

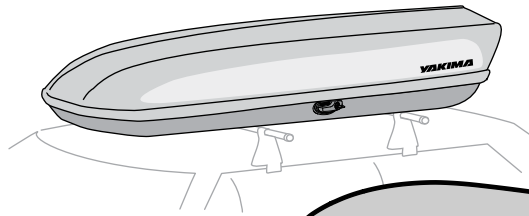

SKYBOX (1X)

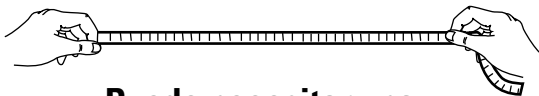
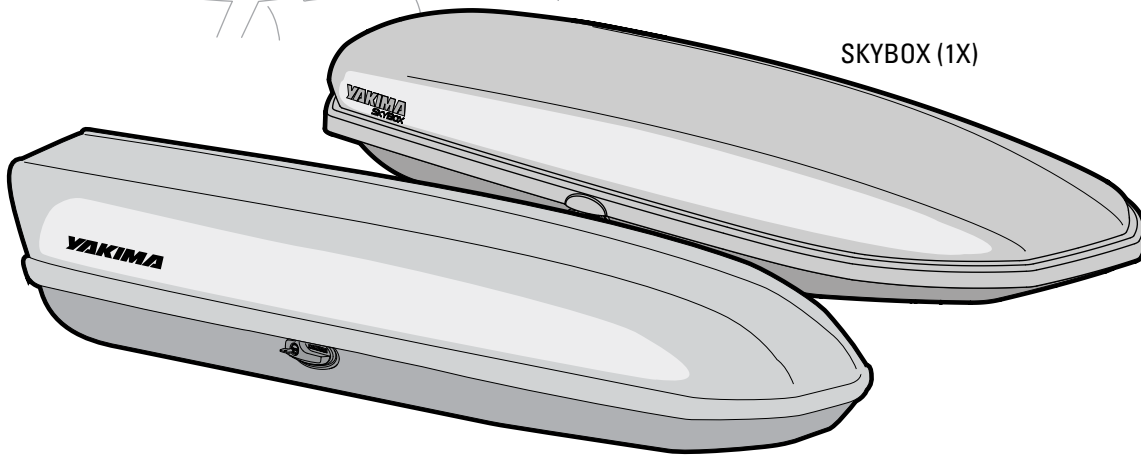

Puede necesitar una cinta de medir o regla.



PARA VERIFICAR LA COMPATIBILIDAD DE ESTE PRODUCTO CON SU VEHÍCULO, VISITE WWW.YAKIMA.COM, O LLAME AL (888) 925-4621.

LÍMITES MÁXIMOS DE CARGA:



Carga de la caja

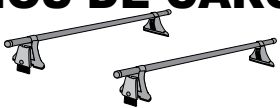

peso del portaequipaje (si se aplica)

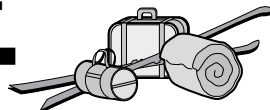

Contenido de la caja



¡NO SUPERE EL LÍMITE DE PESO DE SU PARRILLA!

Consulte a su concesionario Yakima sobre los límites de peso para su vehículo o, en la Internet, vaya a "Choose my Rack" en yakima.com.

SkyBox 12.....	41 lbs. / 19 kg
SkyBox 16.....	47 lbs. / 21 kg
SkyBox 18.....	52 lbs. / 24 kg
SkyBox Lo.....	52 lbs. / 24 kg
SkyBox 21.....	62 lbs. / 28 kg

AVISO IMPORTANTE!

ES FUNDAMENTAL QUE TODAS LAS PARRILLAS Y ACCESORIOS YAKIMA ESTÉN BIEN COLOCADOS Y ASEGURADOS AL VEHÍCULO. UNA INSTALACIÓN DEFICIENTE PODRÍA RESULTAR EN ACCIDENTE AUTOMOVILÍSTICO Y PROVOCAR HERIDAS GRAVES O MUERTE A USTED O A TERCEROS. USTED ES RESPONSABLE DE ASEGURAR LAS PARRILLAS Y ACCESORIOS AL VEHÍCULO, VERIFICANDO UNIONES Y AMARRES ANTES DE USAR E INSPECCIONANDO EL AJUSTE DE LOS PRODUCTOS, SU DESGASTE Y POSIBLES DAÑOS. POR ELLO DEBE LEER Y COMPRENDER TODAS LAS INSTRUCCIONES Y ADVERTENCIAS QUE VIENEN CON LOS PRODUCTOS YAKIMA ANTES DE INSTALARLOS O USARLOS. SI NO ENTIENDE TODAS LAS INSTRUCCIONES Y ADVERTENCIAS, O NO TIENE EXPERIENCIA EN MECÁNICA O NO ESTÁ FAMILIARIZADO CON LOS PROCEDIMIENTOS DE INSTALACIÓN, HAGA INSTALAR EL PRODUCTO POR UN PROFESIONAL EN UN GARAGE RECONOCIDO O UN TALLER DE CARROCERÍA.¡

1

ABRA LA CAJA.

- Inserte la llave. Gírela en sentido antihorario para destrabar la cerradura.
- Gire la manija (la manija no gira si la caja está cerrada con llave).
- Levante para abrir.

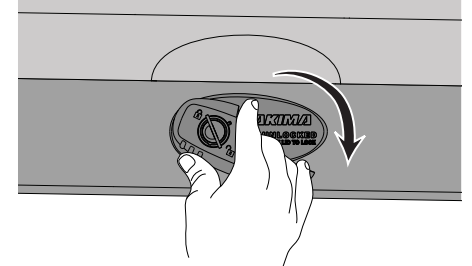
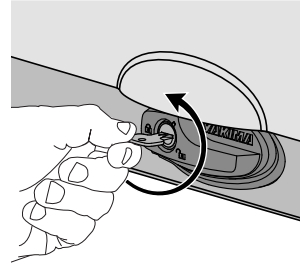

2

La tapa se abrirá en ambos sentidos para facilitar la instalación.

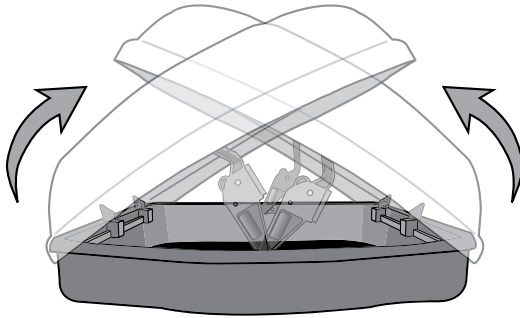

- Los cierres deben estar enganchados antes de abrir el otro lado.
- La caja debe abrirse solamente de un lado cada vez.

DENTRO DE LA CAJA:

3

Abra completamente las palancas para bajar las abrazaderas.

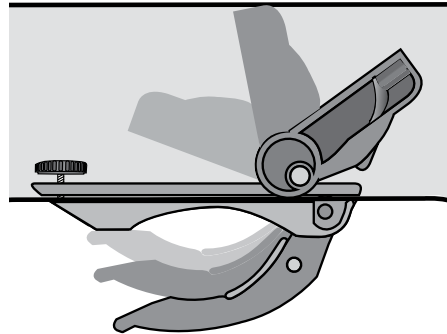

4

Afloje media vuelta la ruedita de pulgar. ¡No quite la ruedita!

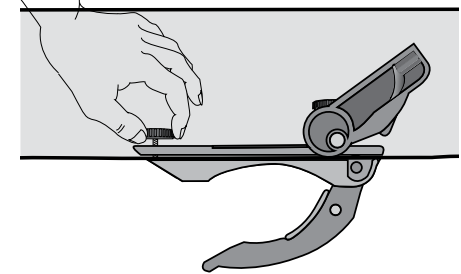

SI QUITA LAS RUEDITAS SE DESMONTARÁ EL MECANISMO DE PALANCA/ABRAZADERA.

CARGUE LA CAJA SOBRE EL VEHÍCULO:



Si su vehículo tiene carena, debe quitarla si hay interferencia con la carena.

5

Coloque la caja sobre el vehículo con las abrazaderas al frente de los travesaños. Un amigo podría ayudar aquí.

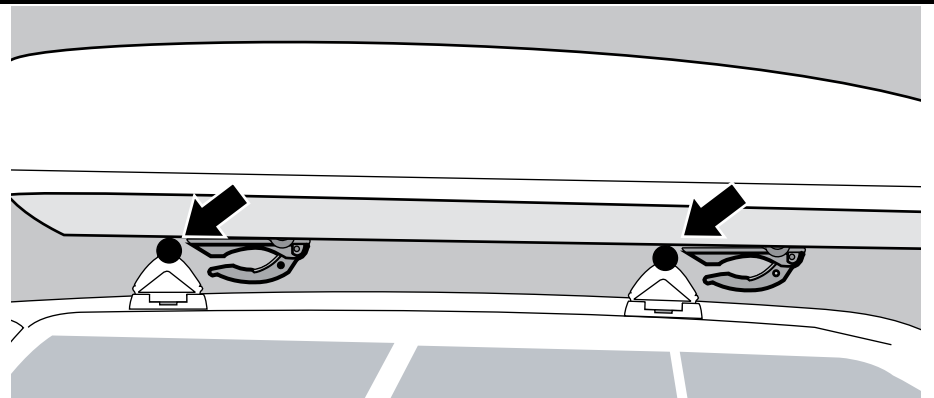

6 ABRA LA TAPA PARA TENER ACCESO A LAS PALANCAS.

Deslice las abrazaderas a lo largo de los rieles para enganchar los travesaños.

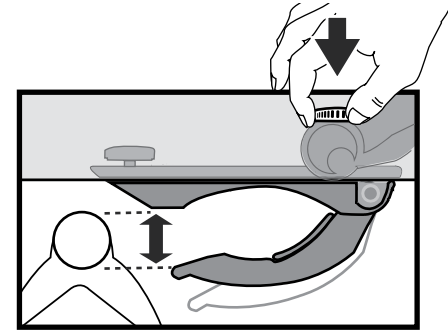
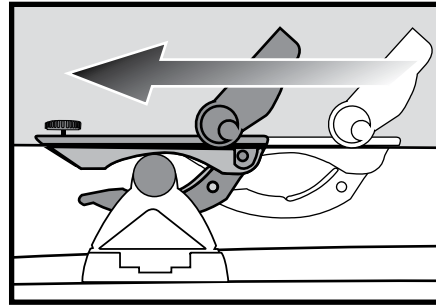
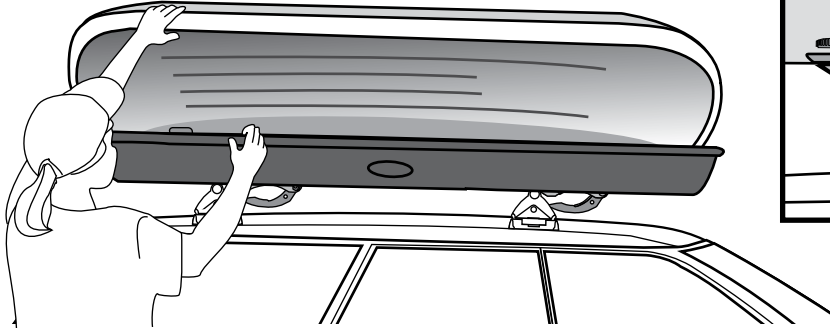

- Verifique la apertura de las abrazaderas para ver si los travesaños entran.
- Aflojar las rueditas de pulgar si es necesario.

7 Ajuste la posición de la caja para lograr una buena alineación.

Siempre ubique la caja de modo de evitar interferencia con la portezuela trasera o el techo corredizo.

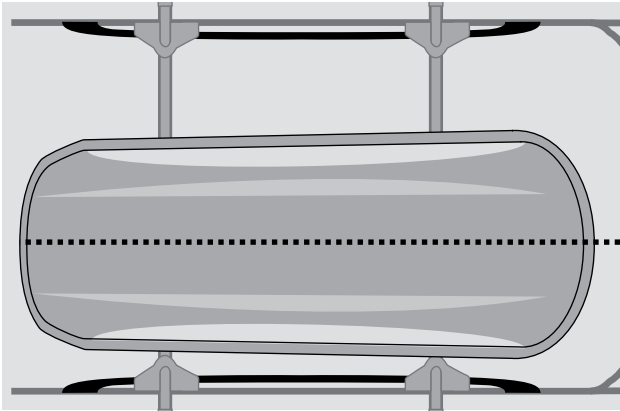

En algunos vehículos la interferencia con la portezuela es inevitable. Abra la portezuela con cautela.



8

Cierre las palancas para enganchar las abrazaderas.

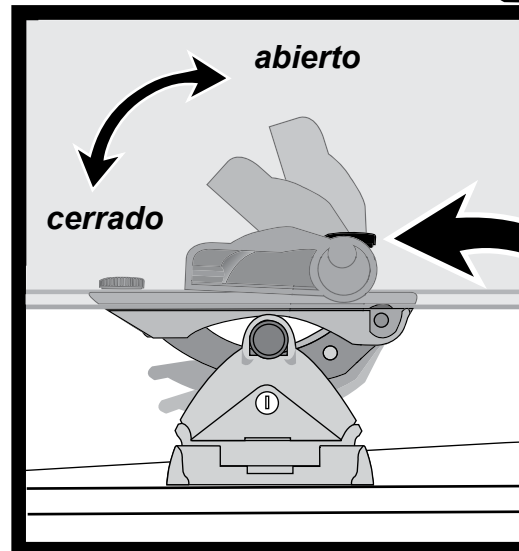

Ajuste las rueditas de pulgar de las palancas hasta que éstas cierren con firme resistencia.

9

AJUSTE TODAS LAS RUEDITAS DE PULGAR.

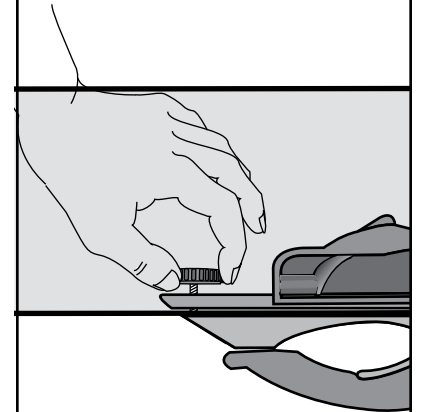

10 CIERRE LA CAJA...

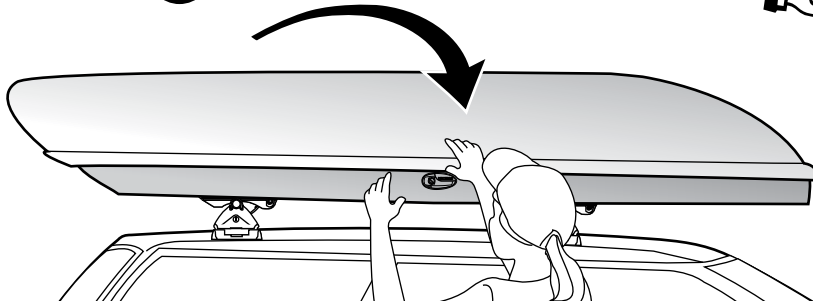

Empuje la tapa hacia abajo hasta que la manija vuelva a la posición horizontal.

La manija debe volver a la posición horizontal para cerrar la caja y poder retirar la llave.

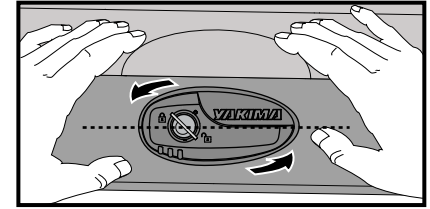
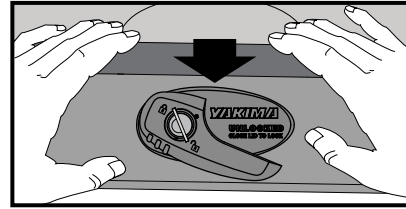

11

VERIFIQUE EL CIERRE—
EMPUJE LA TAPA HACIA ARRIBA

Compruebe que el cierre están enganchado
LEVANTANDO EN AMBOS EXTREMOS.

ATENCIÓN:

Si llena demasiado la caja puede impedir un cierre seguro.

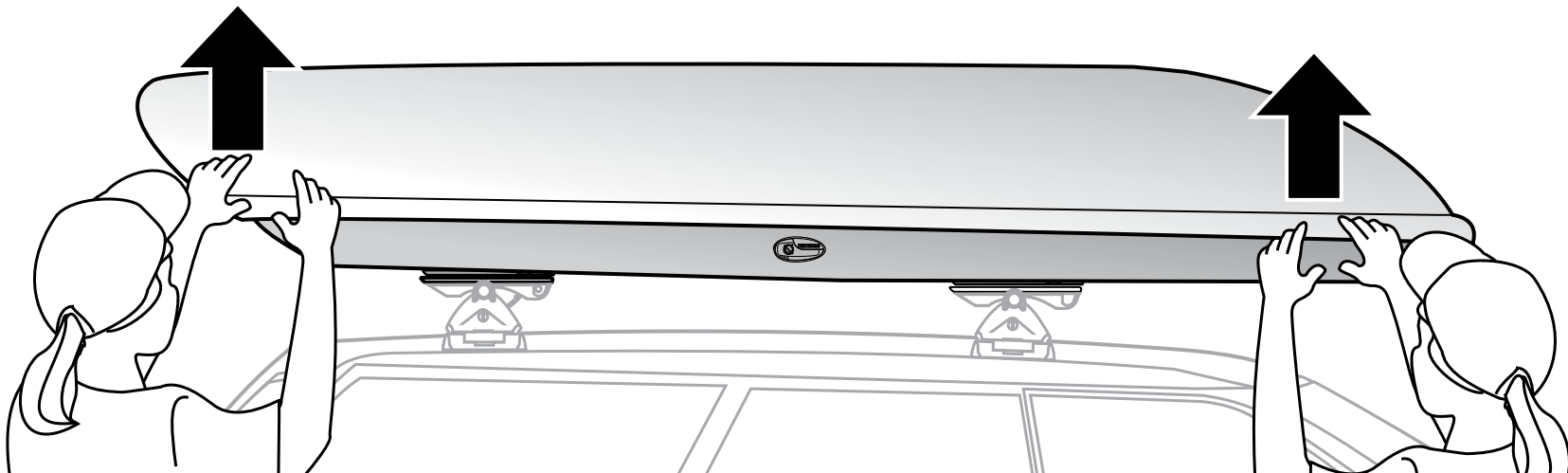

13 VERIFIQUE LA INSTALACIÓN ANTES DE PARTIR

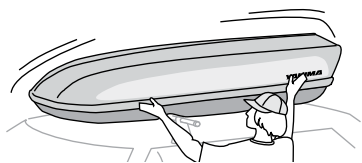

Cerciórese de que la instalación está segura sacudiendo la caja.

- La caja **NO** debe deslizarse sobre los travesaños.
- Abra la caja y ajuste las palancas si es necesario.

COLOQUE LOS ARTÍCULOS MÁS PESADOS EN EL CENTRO Y FONDO DE LA CAJA.

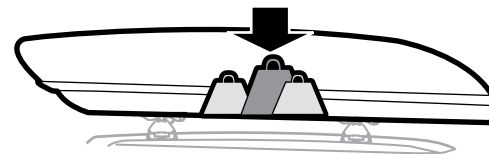

SIEMPRE ASEGURE LA CARGA DENTRO DE LA CAJA.

Use los agujeros para amarre en los rieles.

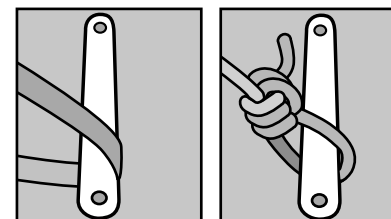

Para trancar...

- Gire la llave en sentido horario.
- Para desatrarcar, inserte la llave y gírela en sentido antihorario.

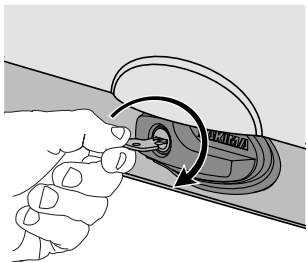

NOTA: La caja debe estar cerrada y la manija en la posición horizontal para cerrar la caja y poder retirar la llave.

Para reemplazar el tambor del cerrojo...

- Cierre la caja.

- Inserte la llave y gírela 45° en sentido antihorario. Retire la llave.

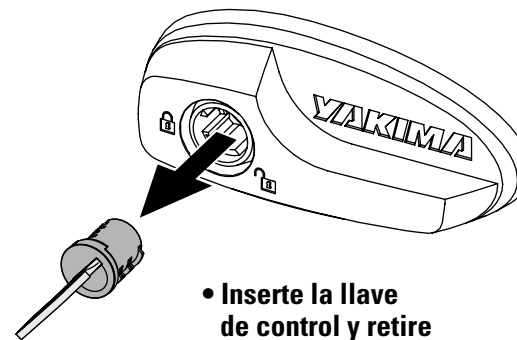
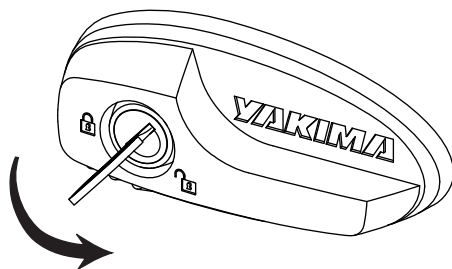

- Inserte la llave de control y retire el tambor con dicha llave.

- Instale el nuevo tambor. Siga las instrucciones que vienen con el tambor del cerrojo.

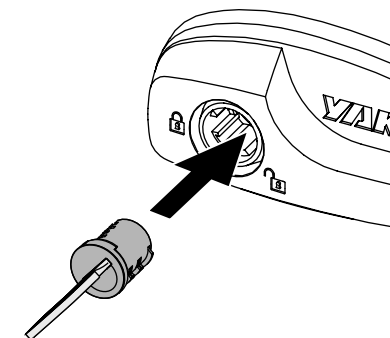

PARA QUITAR LA CAJA DE CARGA:

- No quite ni ajuste las rueditas de pulgar.
- Simplemente levante las palancas y quite la caja de los travesaños.

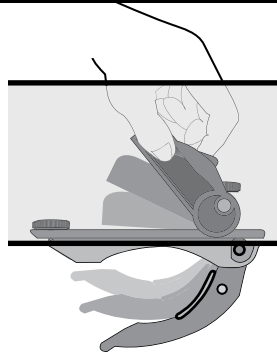

PARA REINSTALAR:

- Con la caja ajustada a su vehículo, para reinstalarla simplemente vuelva a colocarla sobre el vehículo, cierre las palancas y verifique el ajuste.



Para conservar los ajustes hechos a su vehículo, deje ajustadas las rueditas de pulgar.

SI QUITA LAS RUEDITAS DE PULGAR SE DESMONTARÁ EL MECANISMO DE PALANCA ABRAZADERA.

CUIDADO Y MANTENIMIENTO

Las cajas Pro Series deben cuidarse y mantenerse, especialmente en condiciones meteorológicas extremas.

- Para limpiar, use solamente detergentes suaves. Los detergentes duros pueden dañar la superficie de la caja.
- Proteja su caja de temperaturas extremas, calor o frío durante el almacenamiento prolongado.
- Quite la caja antes de entrar en un lavadero automático de vehículos.
- Las piezas, como los cierres, deben lubricarse con grafito u otro lubricante seco.

ADVERTENCIA

SI SU VEHÍCULO TIENE UNA PORTEZUELA TRASERA:

En algunos vehículos la interferencia con la portezuela es inevitable. Abra la portezuela con cautela.



Si su vehículo tiene carena, debe quitarla si hay interferencia con la carena.

¡LEA ESTAS ADVERTENCIAS!

Periódicamente verifique las palancas dentro de la caja y ajuste si es necesario.

LAS PIEZAS Y ACCESORIOS PUEDEN AFLOJARSE CON EL TIEMPO. VERIFIQUE Y AJUSTE SI ES NECESARIO ANTES DE CADA USO.

CERCIÓRESE DE QUE TODO EL EQUIPO ESTÁ ASEGURADO SEGÚN LAS INSTRUCCIONES. NO VERIFICAR LA SEGURIDAD ANTES DE PARTIR PODRÍA RESULTAR EN DAÑOS A LA PROPIEDAD, HERIDAS CORPORALES O MUERTE.

CONSERVE ESTAS INSTRUCCIONES

SI NECESITA MÁS ASISTENCIA TÉCNICA O REPUESTOS:
comuníquese con su concesionario o llámenos al (888) 925-4621 de lunes a viernes de 7:00 A.M. a 5:00 P.M., hora del Pacífico.



Este producto está cubierto por la garantía limitada a vida

“mientras dure el romance” de YAKIMA

Para obtener una copia de esta garantía, visítenos en www.yakima.com, envíenos un correo electrónico a yakwarranty@yakima.com o llámenos al (888) 925-4621.