

MAKO SADDLE

YAKIMA



BEFORE DRIVING AWAY! • AVANT DE PRENDRE LA ROUTE! • ANTES DE PARTIR!

Tie down front AND rear of craft.

Attacher l'avant ET l'arrière de l'embarcation.

Amarre la parte anterior Y la posterior de la embarcación.



Be sure shark chucks fit securely into nose of saddle and straps are tight.

Vérifier que les retenues en forme de requin sont bien en place dans le bout des selles et que les sangles sont serrées.

Asegúrese de que los retenes encajan con seguridad en la nariz de cada silla.

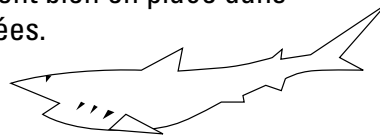

Be sure all hardware is secured according to instructions.

S'assurer que le matériel est fixé selon les instructions.

Asegúrese de que ha guardado en sus lugares todas las herramientas según las instrucciones.

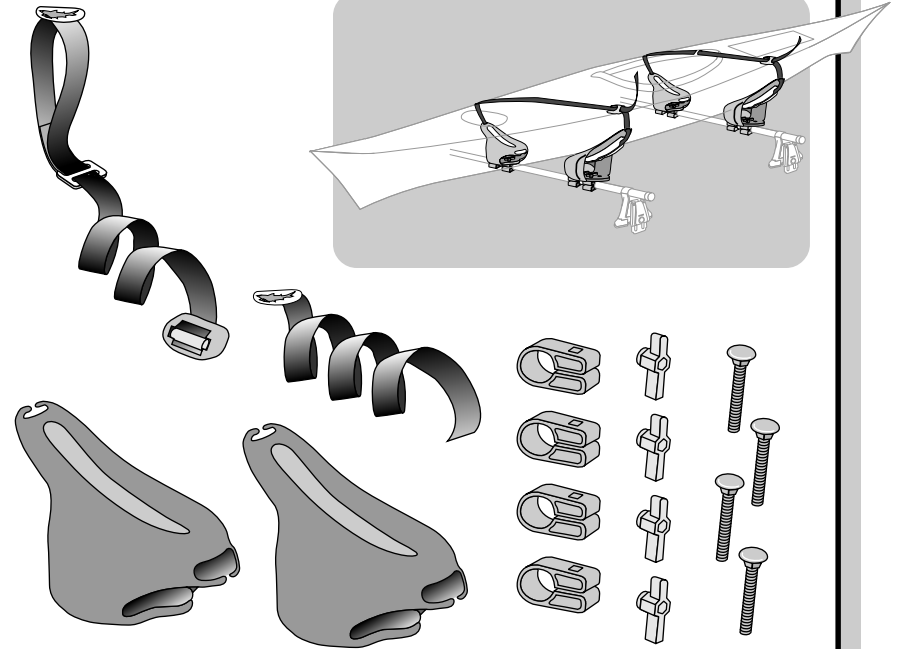

Part# 1031686 Rev A

1 Install SnapAround

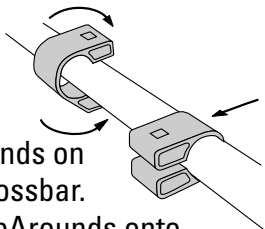

Place SnapArounds on FRONT crossbar. Push SnapArounds onto crossbar facing in opposite directions as shown.

If you are using MightyMounts, follow the MightyMount instructions.

2 Install Saddles

Install Saddle using two SnapArounds. Push bolts through SnapArounds, then into Saddle. Attach hex keys and tighten. Repeat for other saddle.

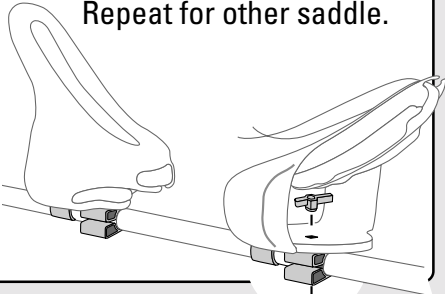

3 Install a second pair of Saddles or a pair of Hully Rollers on REAR crossbar. Repeat steps 1-5 for other Saddle or follow installation instructions for Hully Rollers.

4 Load Craft

Place craft in Saddles. Adjust position of Saddles as needed. Loosen SnapArounds thoroughly before sliding Saddles along crossbars. When Saddles are positioned as desired, tighten SnapArounds completely.

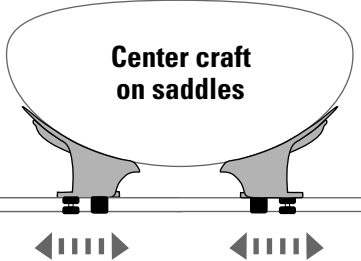

Center craft on saddles

5 Install Straps

OUTBOARD **INBOARD**

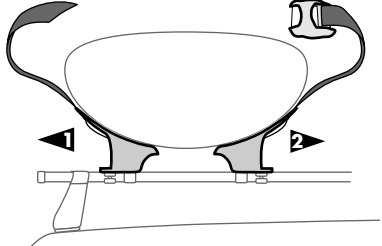
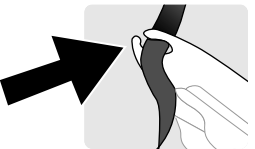
➤ Insert plain strap into notch at top of **OUTBOARD** saddle.

➤ Insert **BUCKLE** strap into notch at top of **INBOARD** saddle.

➤ Loop straps through saddle, placing straps in groove on underside of each pad.

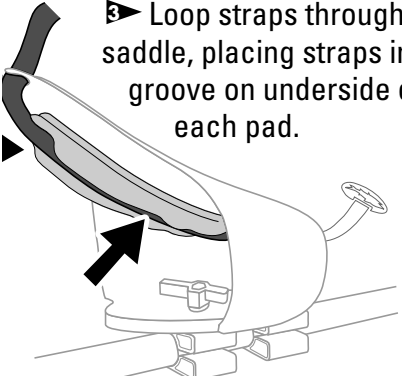

➤ Insert shark chucks securely into slot in nose of each saddle.

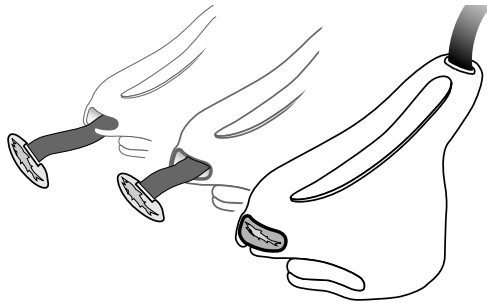

6 Tighten Straps

➤ Slide rubber-buckle protector up the strap.

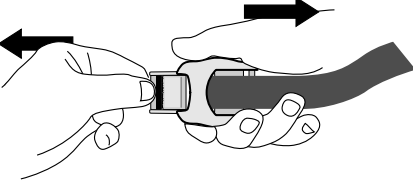

➤ Insert end of plain strap into buckle as shown.

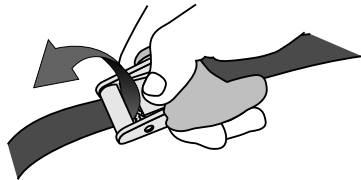

➤ Tighten straps.

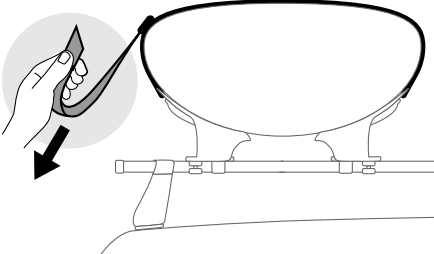

Test movement by rocking boat.
Tighten again if loose.



1

Poser les colliers SnapAround

Placer les colliers SnapAround sur la barre transversale **AVANT**. Engager les colliers sur la barre en sens opposé, tel qu'illustré. Si l'on emploie des colliers MightyMount, suivre les instructions qui les accompagnent.

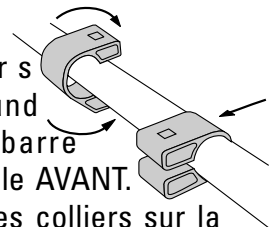

2

Poser les selles

Poser les selles à l'aide de deux colliers chacune. Enfiler le boulon à travers le collier, puis la selle. Mettre en place l'écrou à ailettes et le serrer. Procéder de même pour l'autre selle.

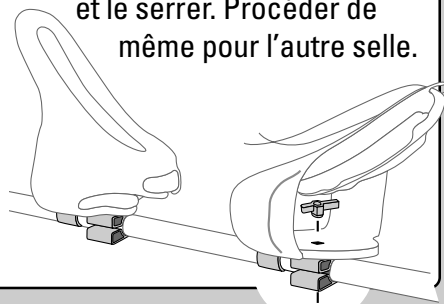

3

Installer une autre paire de selles Mako ou une paire de rouleaux Hully Rollers sur la barre transversale **ARRIÈRE**. Répéter les opérations 1 à 5 pour les autres selles ou suivre les instructions de montage des rouleaux Hully Rollers.

4

Charger l'embarcation

Déposer l'embarcation sur les selles. Régler la position des selles selon la forme de la coque. Desserrer les colliers SnapAround complètement avant de faire glisser les selles le long de la barre. Une fois les selles dans la position voulue, serrer les colliers de nouveau complètement.

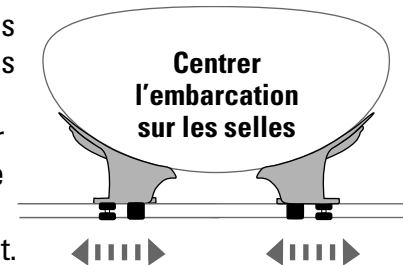

5

Poser les sangles

◀ **EXTÉRIEUR** **INTÉRIEUR** ▶

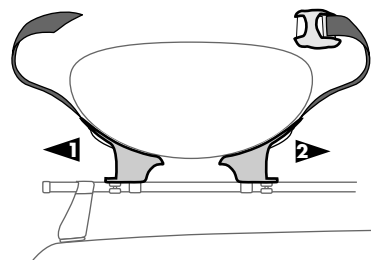

▶ Enfiler la sangle sans boucle dans la coque au sommet de la selle EXTÉRIÈRE.

▶ Enfiler la sangle avec boucle dans la coque au sommet de la selle INTÉRIÈRE.

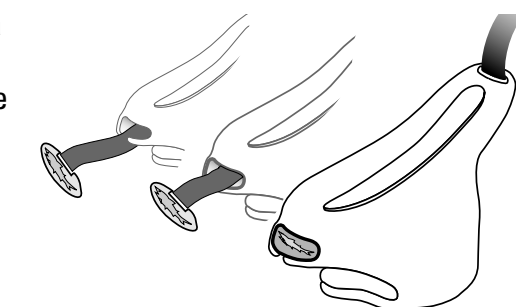
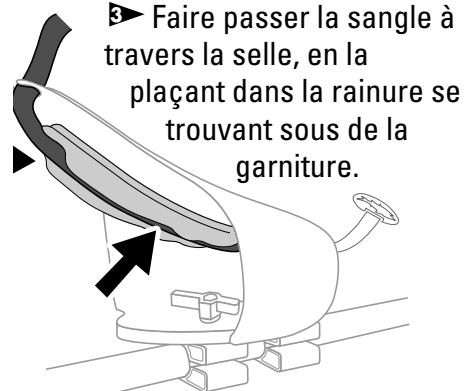

▶ Placer fermement la retenue en forme de requin dans le bout de la selle.

6

Serrer les sangles

▶ Faire coulisser la protection en caoutchouc jusqu'à la boucle.

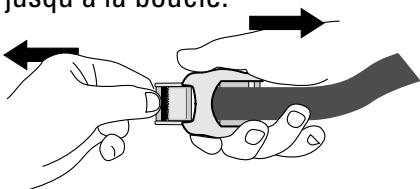

▶ Enfiler le bout de la sangle sans boucle dans la boucle tel qu'illustré.

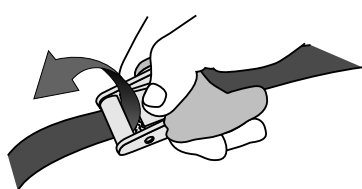

▶ Serrer les sangles.

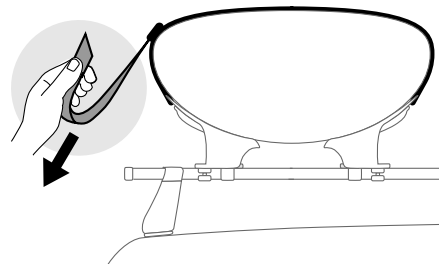

Vérifier la solidité du montage en balançant l'embarcation. Serrer les sangles ou les boulons un peu plus s'il y a du jeu.



1 Instale los broches SnapAround

Coloque los SnapAround sobre el travesaño **DELANTERO** ubicándolos en sentidos opuestos según se indica.

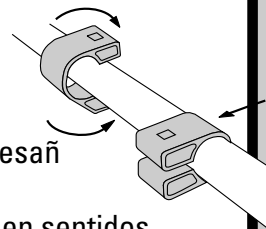

Si utiliza MightyMount, siga las instrucciones correspondientes.

2 Instale las sillas (Saddles)

Instale la silla con dos SnapAround. Coloque los tornillos a través del broche y luego a la silla. Ponga las tuercas hexagonales y ajuste. Repita para la otra silla.



3

Instale un segundo par de sillas o un par de HullyRollers en el travesaño **TRASERO**. Repita los pasos 1 a 5 para la otra silla o siga las instrucciones para HullyRollers.

4 Cargue la embarcación

Coloque la embarcación sobre las sillas. Ajuste la posición de éstas si es necesario. Afloje bien los SnapAround antes de deslizar las sillas por los travesaños. Cuando las sillas estén ubicadas en la posición deseada, ajuste bien los SnapAround.

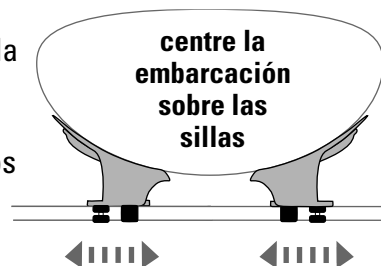

5 Instale las correas

HACIA AFUERA HACIA ADENTRO

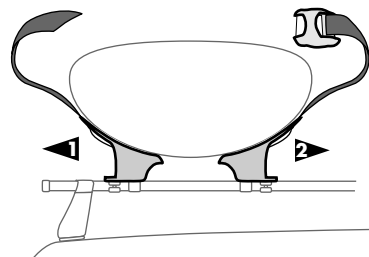

- ▶ Inserte la correa sencilla en la ranura en el tope de la silla de **AFUERA**.
- ▶ Inserte la correa de la HEBILLA en la ranura en el tope de la silla de **ADENTRO**.

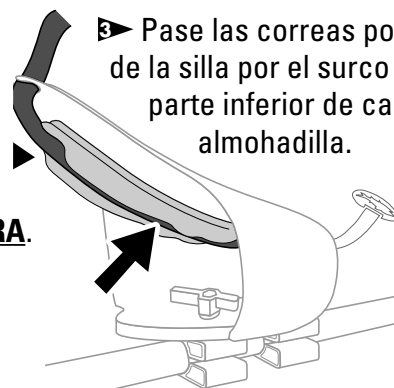

- ▶ Pase las correas por dentro de la silla por el surco de la parte inferior de cada almohadilla.

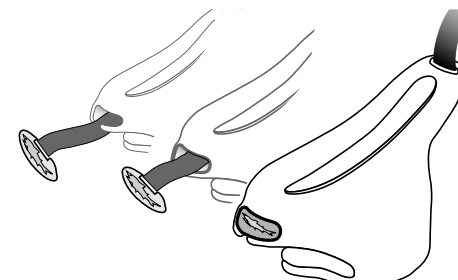

- ▶ Inserte los sujetadores (retenes) firmemente en las ranuras de la nariz de cada silla.

6 Ajuste las correas

- ▶ Deslice el protector de goma de la hebilla por la correa.

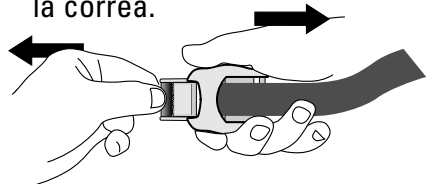

- ▶ Inserte el extremo de la correa sencilla en la hebilla como se indica.

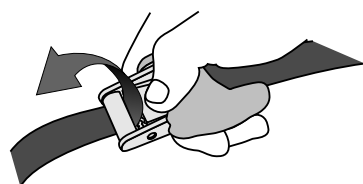

- ▶ Ajuste las correas.

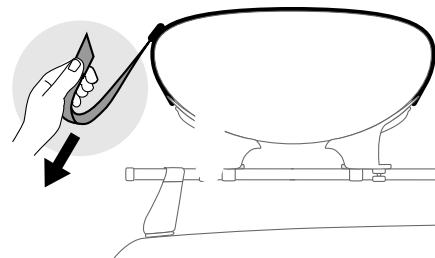

Compruebe si hay movimientos sacudiendo la embarcación.

Ajuste las correas o las piezas de montaje si están flojas.

