

MightyMount 24H

YAKIMA

MightyMounts replace SnapArounds for factory installed racks. Follow accessory instructions and use this reference sheet to attach your accessory.

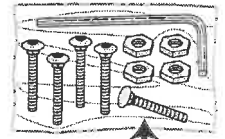
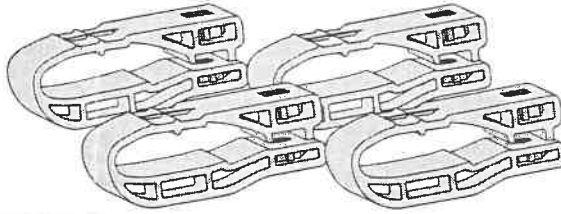

UPRIGHT BIKES:
Bolt for wheel tray.

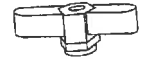

Use at rear of wheel tray with bolt.

1 PRESS the nuts firmly into each of the MightyMounts.

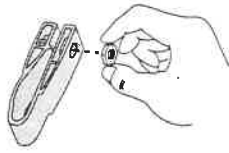

Bikes: Do not press nuts into the MightyMount at rear of wheel tray.

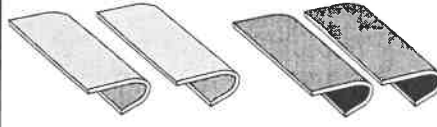
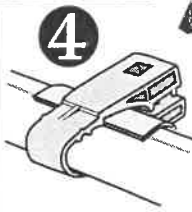
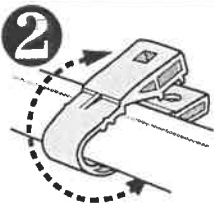

UPRIGHT BIKES:
BLACK caps must go on FRONT bars.

KAYAKS & BASKET CASES:
ALTERNATE the grey and black caps.

UPRIGHT BIKES

Which baseplate do you have?

Ridged Baseplate

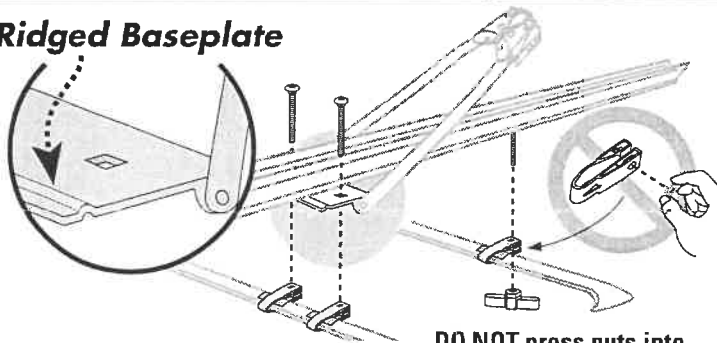

DO NOT press nuts into MightyMount at rear of wheel tray.

Angled Baseplate

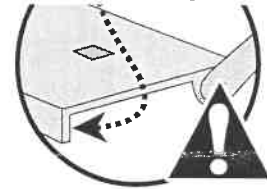

If you have this baseplate call us for the MightyMount Spacer Kit Part #8820062

888-925-4621

BASKETCASE

MAKO SADDLES

LANDSHARK

HULLY ROLLERS

KAYAK STACKERS

If you have this accessory call us for the Bolt Upgrade Kit Part #8860007

888-925-4621

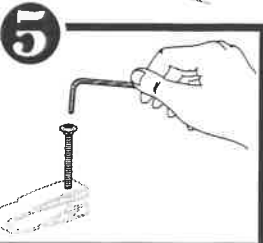

DO NOT EXCEED THE FACTORY WEIGHT LIMIT OF YOUR VEHICLE'S RACKS.



Secure front and rear of long loads to ends of vehicle for safe transport. Failure to do so can result in property damage, personal injury, or death.