

# YAKIMA FreshSesh, PowderHound & Big PowderHound

US

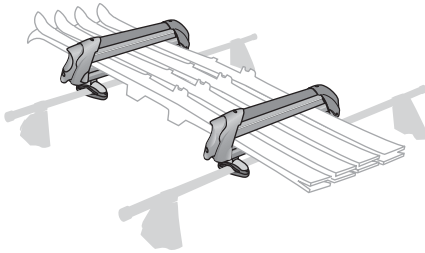

**CARRIER (2x)**

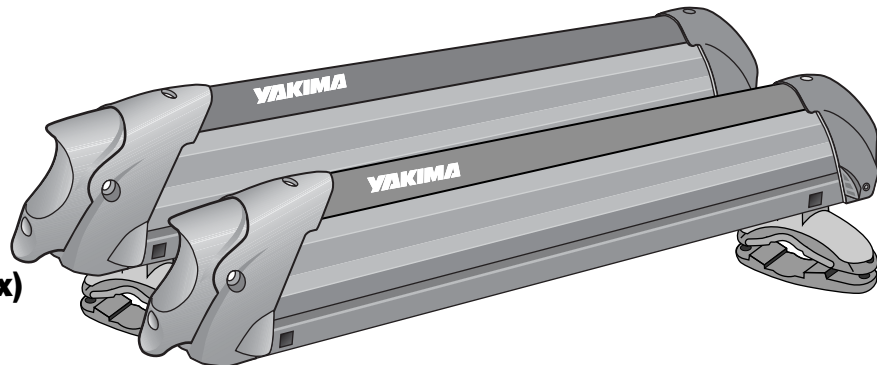

**universal mounting bracket (4x)**

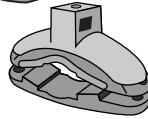

**SKILIFT (2x)**

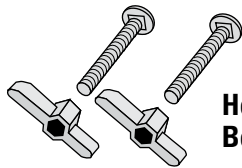

**Hex Key with Bolt (2x)**

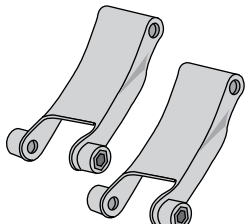

**SkiLift (2x)**

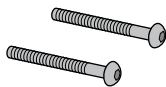

**Button Head Screw (2x)**

**(MOUNTING BRACKET PARTS:)**

Hex Wrench (1x)

Base Screw (4x)

Slider Top (4x)

Bail Screw (8x) *installed*

Long Bail Screw (8x) *for some larger factory bars*

Upper Bail (4x)

Square Nut (4x)

Pad (4x)

Lower Bail (4x)

Vinyl Pad Sheets (2x) *for factory bars*



**IMPORTANT WARNING: IT IS CRITICAL THAT ALL YAKIMA RACKS AND ACCESSORIES BE PROPERLY AND SECURELY ATTACHED TO YOUR VEHICLE. IMPROPER ATTACHMENT COULD RESULT IN AN AUTOMOBILE ACCIDENT, AND COULD CAUSE SERIOUS BODILY INJURY OR DEATH TO YOU OR TO OTHERS. YOU ARE RESPONSIBLE FOR SECURING THE RACKS AND ACCESSORIES TO YOUR CAR, CHECKING THE ATTACHMENTS PRIOR TO USE, AND PERIODICALLY INSPECTING THE PRODUCTS FOR ADJUSTMENT, WEAR, AND DAMAGE. THEREFORE, YOU MUST READ AND UNDERSTAND ALL OF THE INSTRUCTIONS AND CAUTIONS SUPPLIED WITH YOUR YAKIMA PRODUCT PRIOR TO INSTALLATION OR USE. IF YOU DO NOT UNDERSTAND ALL OF THE INSTRUCTIONS AND CAUTIONS, OR IF YOU HAVE NO MECHANICAL EXPERIENCE AND ARE NOT THOROUGHLY FAMILIAR WITH THE INSTALLATION PROCEDURES, YOU SHOULD HAVE THE PRODUCT INSTALLED BY A PROFESSIONAL INSTALLER SUCH AS A QUALIFIED GARAGE OR AUTO BODY SHOP.**

Part #1033382 Rev.C

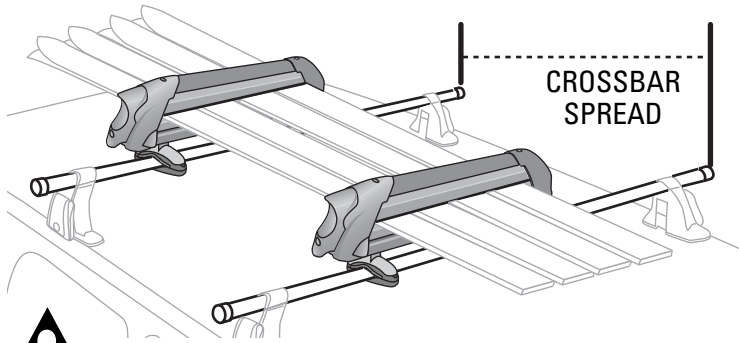

**SKIS AND BOARDS  
UNDER 170 cm:**  
*Crossbar spread must be  
between 12" and 24"*

**SKIS AND BOARDS  
OVER 170 cm:**  
*Crossbar spread must be  
between 12" and 36"*



**YAKIMA Q TOWERS: DO NOT REPOSITION YOUR TOWERS!**

**1**

**REMOVE BASE SCREW**

Use hex wrench.

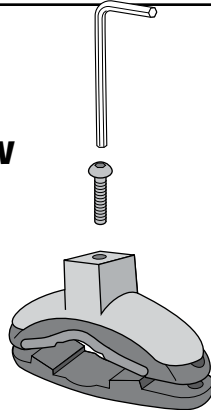

**2**

**REMOVE ONE BAIL SCREW**

- Use hex wrench.
- Loosen the remaining screw, but leave it in place.

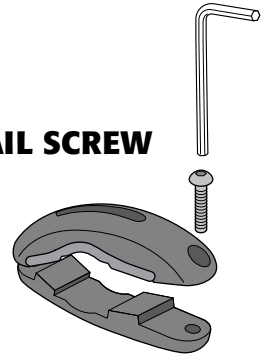

**3**

**FACTORY BARS:  
CHECK FOR PROPER SCREW LENGTH**

- Some factory bars may require the long bail screws.
- Screws must extend below bail.

IF SCREWS ARE TOO SHORT,  
USE THE LONGER SCREWS  
INCLUDED

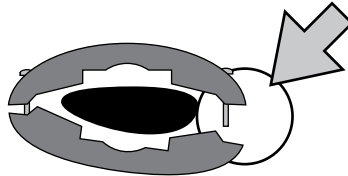
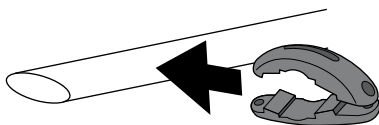

*In some cases, the bails  
may not be parallel.*

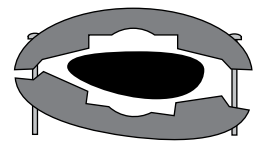

**OK**

**4**

**WORK ON A FLAT SURFACE**

Open carrier (they open two ways):

**LIFT BOTTOM OF BUTTON...**

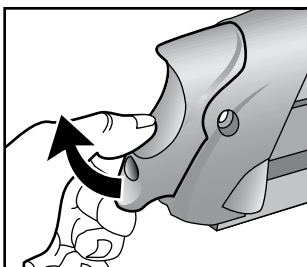

**PUSH TOP OF BUTTON...**

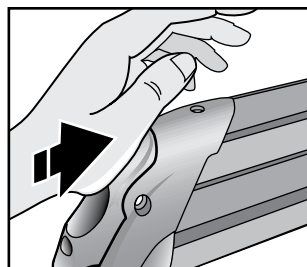

-OR-

**OPEN**

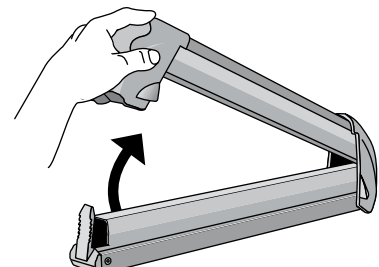

## 5 ASSEMBLE

- Insert base screw through hole in pad.
- Position slider top onto screw.

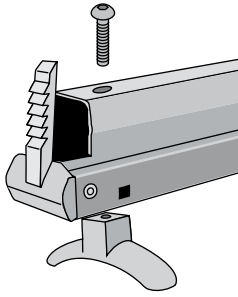

## 6 ATTACH UPPER BAIL TO SLIDER TOP

- Align the base screw with square nut (inside upper bail.)
- Use hex wrench to engage the screw and nut.
- Do not tighten yet.

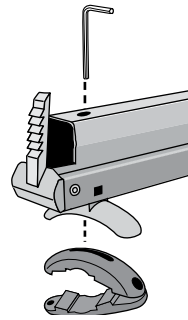

## 7 MOVE SLIDING BAIL TO EXPOSE SCREW HOLES.

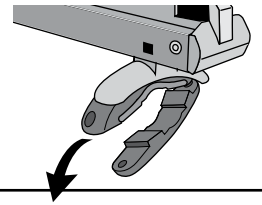

REPEAT ASSEMBLY FOR REMAINING HARDWARE

## 8 CLOSE CARRIER WITH FIRM PRESSURE

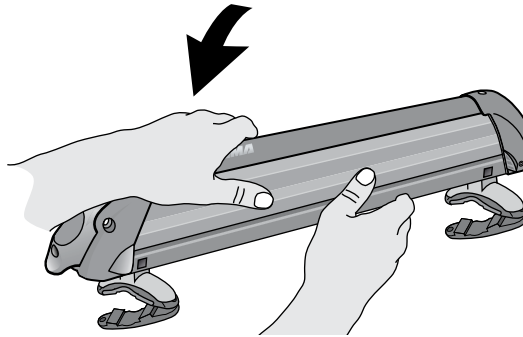

## 9 INSERT SECOND BAIL SCREW THROUGH UPPER BAIL ONLY.

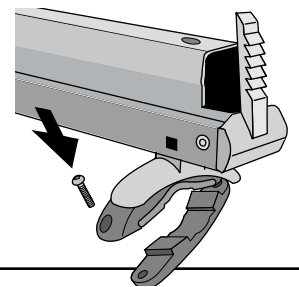

## 10 SLIDE CARRIER ASSEMBLY ONTO CROSSBAR

### ROUND BARS

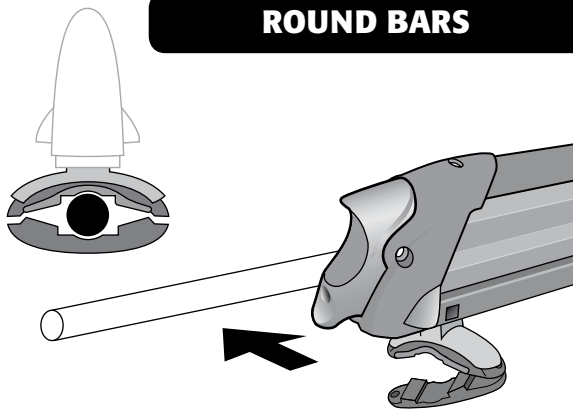

### SQUARE BARS

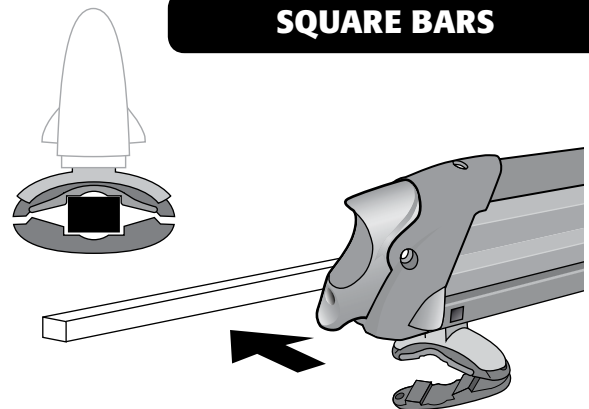

### FACTORY BARS

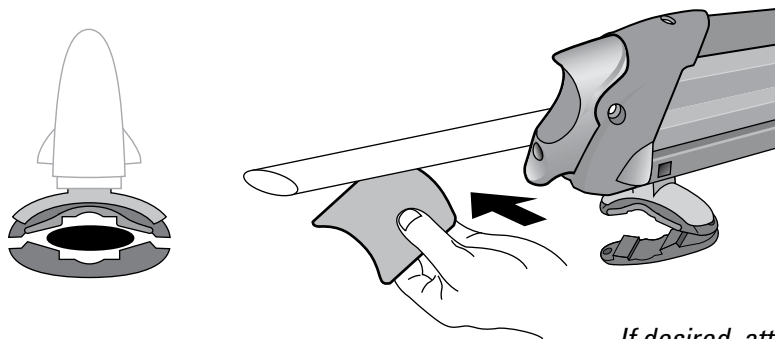

*If desired, attach vinyl pads to underside of factory bars to protect finish.*

## 11 SECURE MOUNTING ASSEMBLY

- Slide carrier to expose unsecured bail screw.
- Use hex wrench to tighten screws.

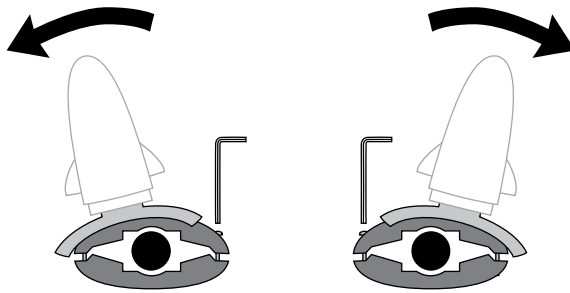

## 12 OPEN CARRIER

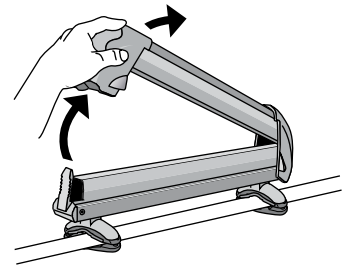

## 13 TIGHTEN CARRIERS TO UNIVERSAL MOUNTS

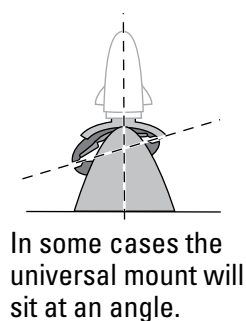
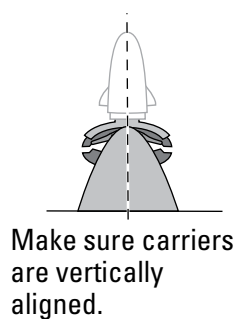
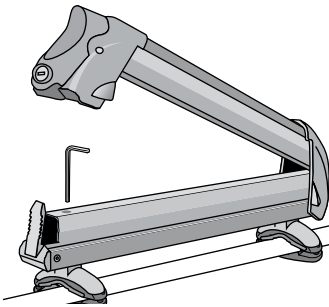

## 14 LOAD SKIS OR SNOWBOARDS

- Load ski tips to the rear of your car.
- Load bindings between the carriers.

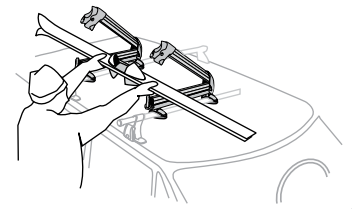

## 15 VERIFY BINDING CLEARANCE

If you have sufficient clearance, PROCEED TO STEP 23

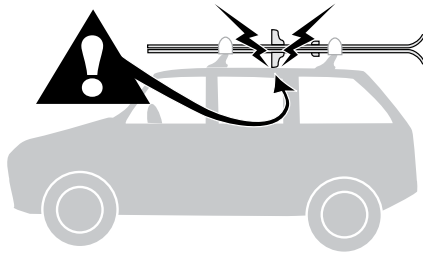

If you need more binding clearance, or if factory bars are arched and cannot align with carriers, CONTINUE TO NEXT STEP FOR SKILIFT ATTACHMENT.

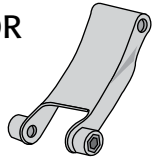

## 16 SKILIFT INSTALLATION: OPEN CARRIERS

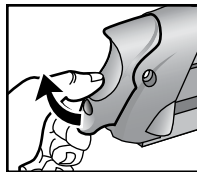
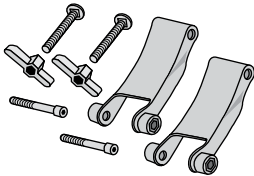

-OR-

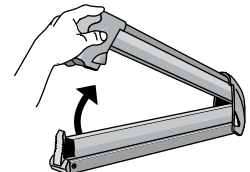
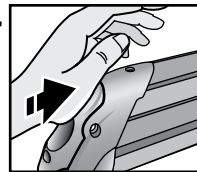

## 17 Remove base screw at hinged-end of carriers.

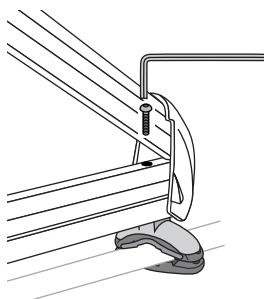

## 18 Loosen front base screw, but do not remove the screw.

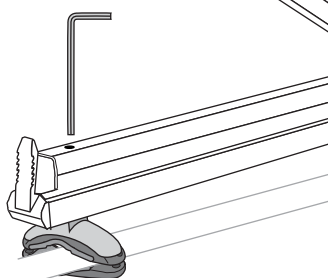

## 19 LIFT HINGED SIDE OF CARRIER

Reinstall base screw into mounting hardware.

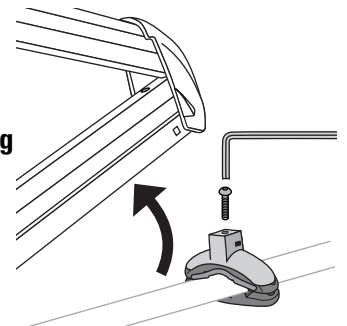

## 20 ATTACH SKILIFT TO UNIVERSAL MOUNT

- Use button head screw.
- Tighten with hex wrench.

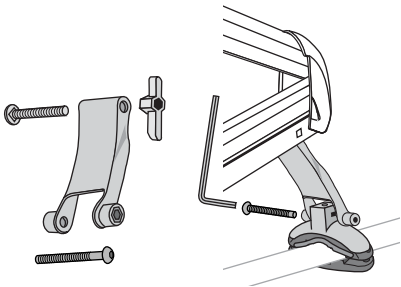

## 21 ATTACH SKILIFT TO CARRIER

- Attach hex bolt and hex key, then tighten.
- Loosen any bail screws to reposition mounting brackets for better fit.

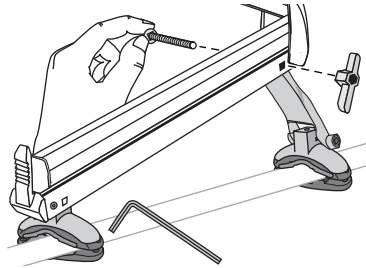

## 22 TIGHTEN FRONT BASE SCREWS

*Tighten any loose bail screws to secure the brackets to the crossbars.*

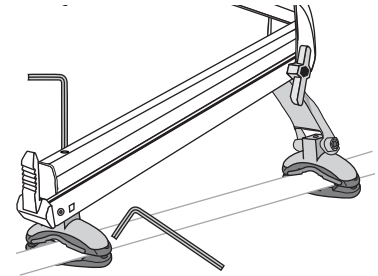

## 23 CLOSE CARRIERS WITH FIRM PRESSURE

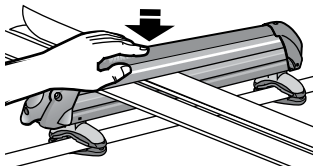

## 24 VERIFY THE CLOSURE!

- Pull upward on upper section of carrier to see if the carrier can open.
- If it opens, apply more pressure when closing the carrier.

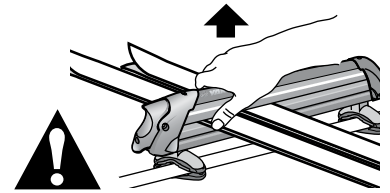

## 25 Install SKS locks according to lock instructions

- Locks are purchased separately.
- CLOSE YOUR CARRIERS BEFORE LOCKING THEM

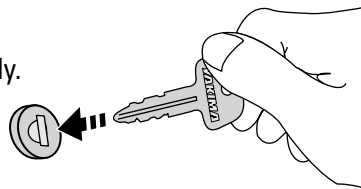

## REAR HATCH

**ALWAYS USE CAUTION WHEN OPENING YOUR HATCH.**

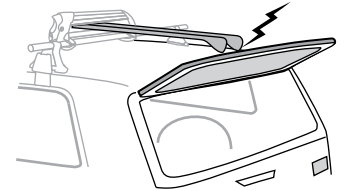

**VERIFY THE CLOSURE AFTER EVERY INSTALLATION AND BEFORE DRIVING AWAY.**  
**If you remove carriers, follow instructions to reinstall.**



**WARNING: BE SURE ALL HARDWARE IS SECURED ACCORDING TO INSTRUCTIONS. ATTACHMENT HARDWARE CAN LOOSEN OVER TIME. CHECK BEFORE EACH USE, AND TIGHTEN IF NECESSARY.**

**MAINTENANCE:** Use non-water soluble lubricant on screws. Use a soft cloth with water and mild detergent to clean plastic parts.

**REMOVE RACKS AND CARRIERS BEFORE ENTERING AN AUTOMATIC CAR WASH.**

**To extend the life of your product, remove the carrier and clean at the end of the season**

**This product is covered by YAKIMA's "Love It Till You Leave It" Limited Lifetime Warranty To obtain a copy of this warranty, go online to [www.yakima.com](http://www.yakima.com) or email us at [yakwarranty@yakima.com](mailto:yakwarranty@yakima.com) or call (888) 925-4621**

**TECHNICAL ASSISTANCE OR REPLACEMENT PARTS**  
Contact your dealer or call (888)925-4621  
Monday through Friday, 7:00 AM to 5:00 PM, PST

**KEEP THESE INSTRUCTIONS!**

# YAKIMA FreshSesh, PowderHound & Big PowderHound

FR

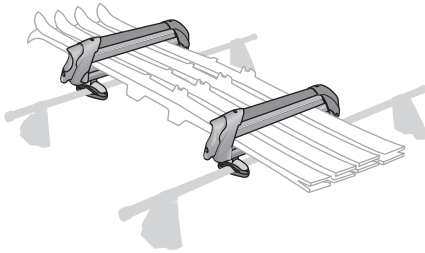

**PORTE-SKIS (X 2)**

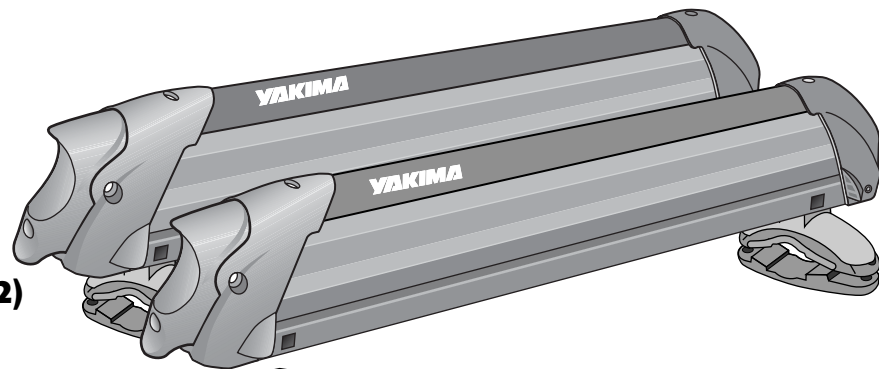

**Collier de montage universel (x 4)**

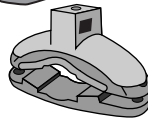

## ENTRETOISES SKILIFT (X 2)

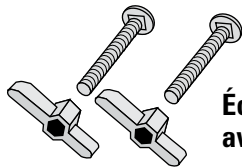

**Écrous à ailettes avec boulons (x 2)**

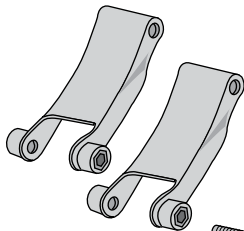



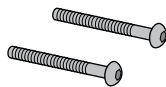



**Entretoises SkiLift (x 2)**

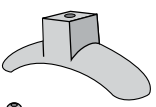

**Vis à tête ronde (x 2)**

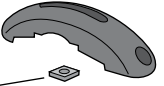
## (PIÈCES D'UN COLLIER DE MONTAGE:)

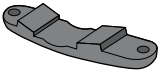
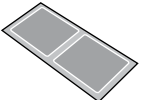
- Clé hexagonale (x 1)** 
- Vis d'assemblage (x 4)** 
- Dessus coulissant (x 4)** 
- Vis de serrage (x 8) installée** 
- Vis de serrage longue (x 8) pour certaines grosses barres d'origine** 
- Mâchoire supérieure (x 4)** 
- Écrou carré (x 4)** 
- Coussinet (x 4)** 
- Mâchoire inférieure (x 4)** 
- Garniture en vinyle (x 2) pour barres d'origine** 



**AVERTISSEMENT IMPORTANT: IL EST IMPÉRATIF QUE LES PORTE-BAGAGES ET LES ACCESSOIRES YAKIMA SOIENT CORRECTEMENT ET SOLIDEMENT FIXÉS AU VÉHICULE. UN MONTAGE MAL RÉALISÉ POURRAIT PROVOQUER UN ACCIDENT D'AUTOMOBILE, QUI POURRAIT ENTRAÎNER DES BLESSURES GRAVES OU MÊME LA MORT, À VOUS OU À D'AUTRES PERSONNES. VOUS ÊTES RESPONSABLE DE L'INSTALLATION DU PORTE-BAGAGES ET DES ACCESSOIRES SUR VOTRE VÉHICULE, D'EN VÉRIFIER LA SOLIDITÉ AVANT DE PRENDRE LA ROUTE ET DE LES INSPECTER RÉGULIÈREMENT POUR EN CONTRÔLER L'ÉTAT, L'AJUSTEMENT ET L'USURE. VOUS DEVEZ DONC LIRE ATTENTIVEMENT TOUTES LES INSTRUCTIONS ET TOUS LES AVERTISSEMENTS ACCOMPAGNANT VOTRE PRODUIT YAKIMA AVANT DE L'INSTALLER ET DE L'UTILISER. SI VOUS NE COMPRENEZ PAS TOUTES LES INSTRUCTIONS ET TOUS LES AVERTISSEMENTS, OU SI VOUS N'AVEZ PAS DE COMPÉTENCES EN MÉCANIQUE ET NE COMPRENEZ PAS PARFAITEMENT LA MÉTHODE DE MONTAGE, VOUS DEVRIEZ FAIRE INSTALLER LE PRODUIT PAR UN PROFESSIONNEL, COMME UN MÉCANICIEN OU UN CARROSSIER COMPÉTENT.**

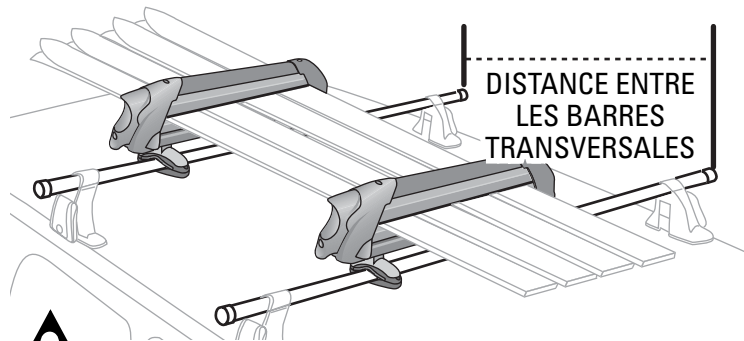

DISTANCE ENTRE  
LES BARRES  
TRANSVERSALES



**POUR LES SKIS ET LES PLANCHES  
DE MOINS DE 170 cm :**

*la distance entre les barres transversales  
doit être de 30 à 61 cm (12 à 24 po).*

**POUR LES SKIS ET LES PLANCHES  
DE PLUS DE 170 cm :**

*la distance entre les barres transversales  
doit être de 30 à 92 cm (12 à 36 po).*



**VÉHICULE MUNI DE PIEDS Q YAKIMA: NE PAS DÉPLACER LES PIEDS!**

**1**

**ENLEVER LA VIS  
D'ASSEMBLAGE**

Employer la clé hexagonale.

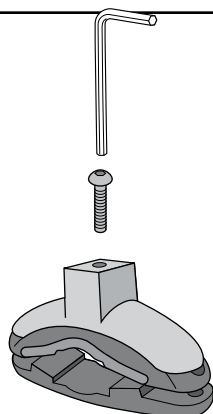

**2**

**ENLEVER UNE DES VIS  
DE SERRAGE**

- Employer la clé hexagonale.
- Desserrer l'autre vis, mais la laisser en place.

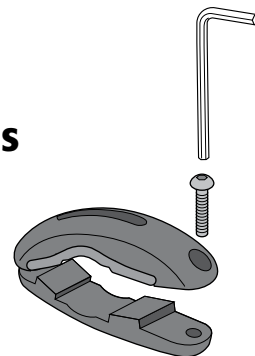

**3**

**BARRES D'ORIGINE :  
VÉRIFIER QUE LES VIS ONT LA BONNE LONGUEUR**

- Pour certaines barres d'origine, il faudra peut-être les vis de serrage longues.
- Les vis doivent dépasser sous la mâchoire.

SI LES VIS SONT TROP  
COURTES, EMPLOYER LES VIS  
LONGUES FOURNIES

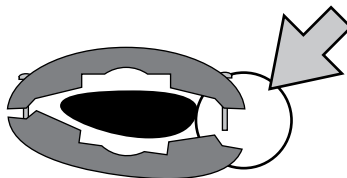
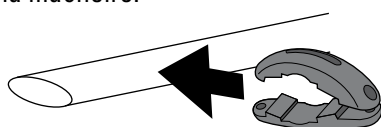

*Dans certains cas, les  
mâchoires ne seront pas  
parallèles.*

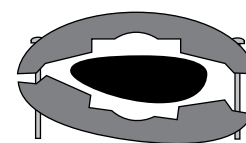

**BIEN**

**4**

**TRAVAILLER SUR UNE SURFACE PLATE**

Ouvrir le porte-skis (il s'ouvre de deux façons) :

**SOULEVER LE BAS DU BOUTON...**

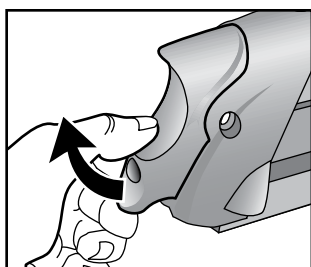

-OU-

**APPUYER SUR LE HAUT DU BOUTON...**

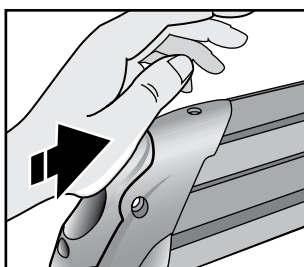

**OUVERT**

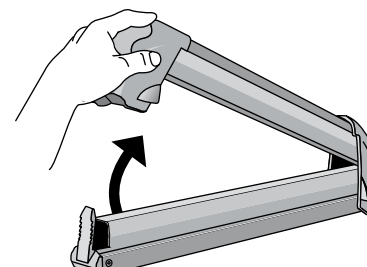

## 5 ASSEMBLAGE

- Enfiler la vis d'assemblage à travers le trou dans le coussinet.
- Enfiler le dessus coulissant sur la vis.

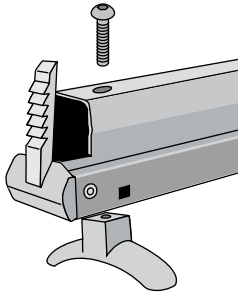

## 6 FIXER LA MÂCHOIRE SUPÉRIEURE AU DESSUS COULISSANT

- Aligner la vis d'assemblage avec l'écrou carré (à l'intérieur de la mâchoire supérieure).
- Engager la vis dans l'écrou avec la clé hexagonale.
- Ne pas serrer pour le moment.

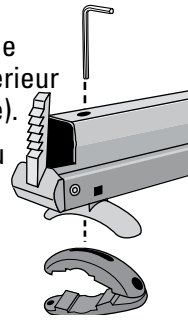

## 7 DÉPLACER LA MÂCHOIRE COULISSANTE POUR AVOIR ACCÈS AUX TROUS DE VIS.

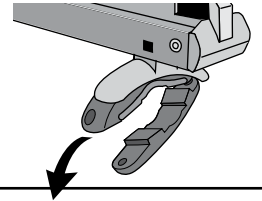

PROCÉDER DE LA MÊME MANIÈRE POUR LES AUTRES MÂCHOIRES

## 8 FERMER LE PORTE-SKIS EN APPUYANT FERMEMENT

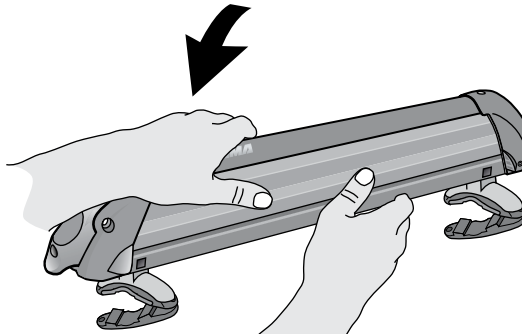

## 9 ENFILER LA DEUXIÈME VIS DE SERRAGE DANS LA MÂCHOIRE SUPÉRIEURE SEULEMENT.

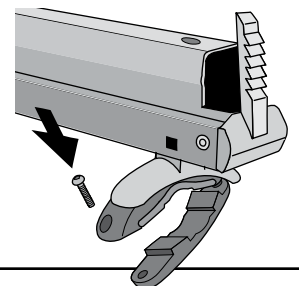

## 10 ENFILER LES PORTE-SKIS SUR LES BARRES TRANSVERSALES

**BARRES RONDES**

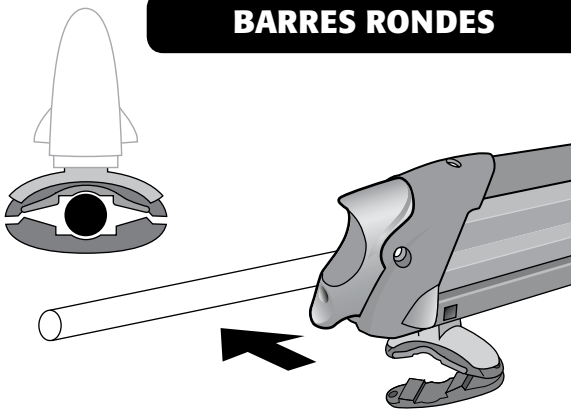

**BARRES CARRÉES**

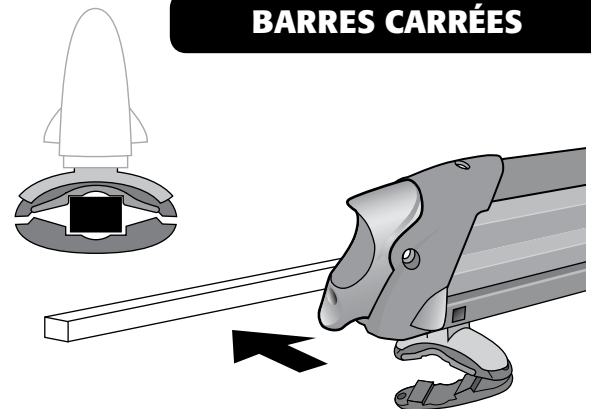

**BARRES D'ORIGINE**

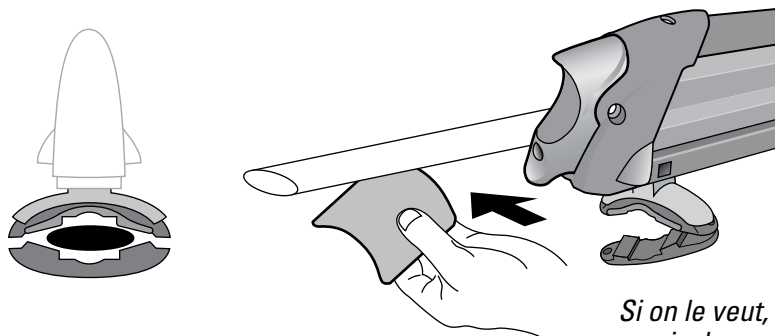

*Si on le veut, on peut coller les garnitures en vinyle sur le dessous des barres d'origine pour en protéger le fini.*



## 11 SERRER LES MÂCHOIRES

- Faire coulisser le porte-skis pour avoir accès à la vis de serrage non encore engagée.
- Serrer les vis à l'aide la clé hexagonale.

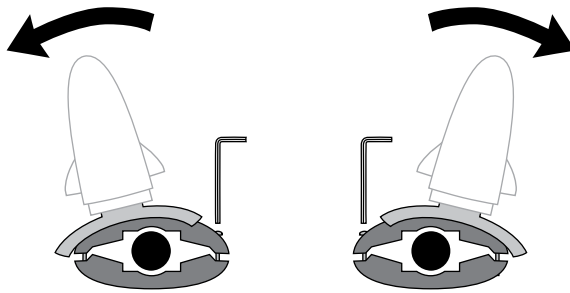

## 12 OUVRIR LE PORTE-SKIS

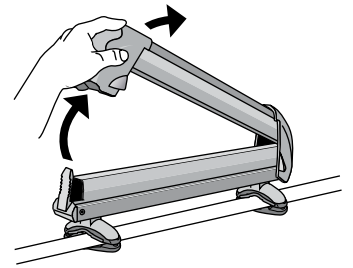

## 13 SERRER LES PORTE-SKIS SUR LES COLLIERS DE MONTAGE UNIVERSELS

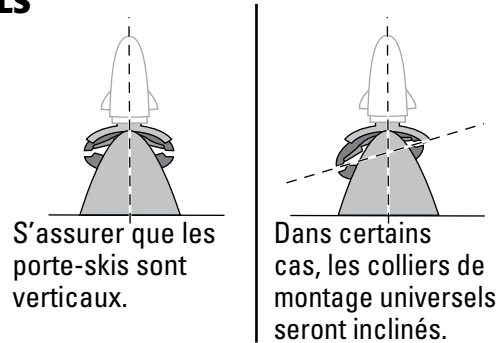
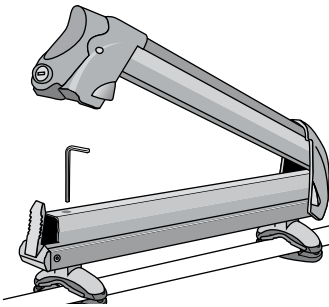

## 14 CHARGER LES SKIS OU LES PLANCHES AVEC LES SPATULES VERS L'ARRIÈRE DU VÉHICULE

Fermer les fixations !

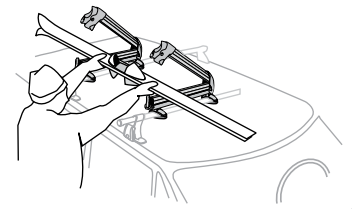

## 15 VÉRIFIER QUE LES FIXATIONS NE TOUCHENT PAS

Si les fixations ne touchent pas, PASSER À L'OPÉRATION 23

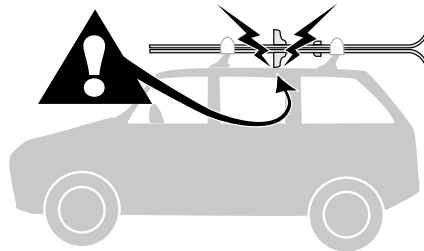

Si les fixations touchent au toit du véhicule, ou si les barres d'origine sont trop cintrées pour que le porte-skis s'y adapte,

PASSER À L'OPÉRATION SUIVANTE, POSE DES ENTRETOISES SKILIFT.

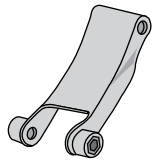

## 16 POSE DES ENTRETOISES SKILIFT : OUVRIR LE PORTE-SKIS

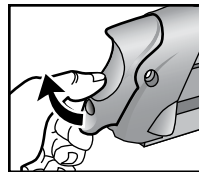
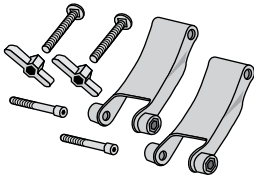

-OU-

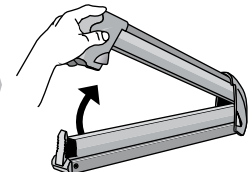
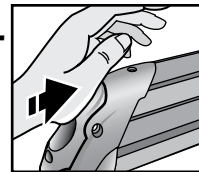

## 17 Enlever la vis d'assemblage au bout articulé des porte-skis.

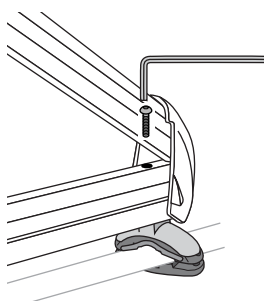

## 18 Desserrer la vis d'assemblage avant, mais sans l'enlever.

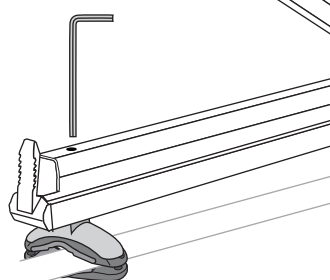

## 19 SOULEVER LE BOUT ARTICULÉ DU PORTE-SKIS

Remettre en place la vis d'assemblage.

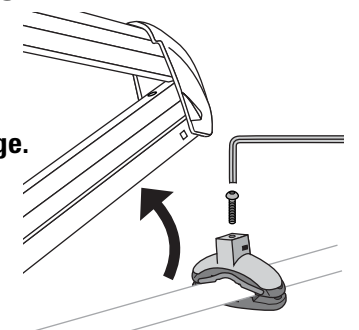

## 20 FIXER L'ENTRETOISE SKILIFT AU COLLIER DE MONTAGE UNIVERSEL

- Employer les vis à tête ronde
- Serrer avec la clé hexagonale.

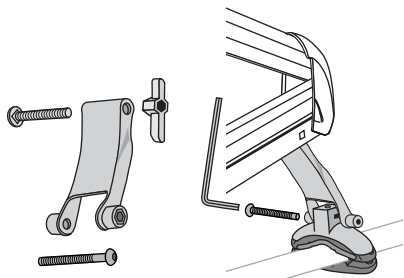

## 21 FIXER L'ENTRETOISE SKILIFT AU PORTE-SKIS

- Enfiler un boulon et un écrou à ailettes. Serrer.
- Au besoin, desserrer les vis de serrage pour mieux repositionner les colliers.

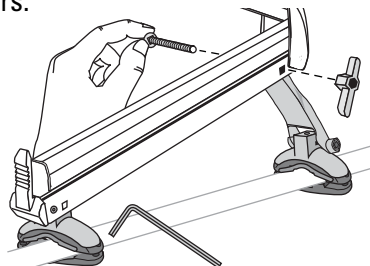

## 22 RESSERRER LES VIS D'ASSEMBLAGE AVANT

*Au besoin, resserrer les vis de serrage pour bien fixer les colliers aux barres transversales.*

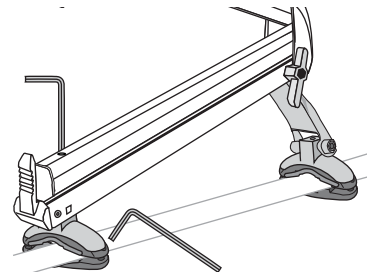

## 23 FERMER LES PORTE-SKIS EN APPLIQUANT UNE PRESSION FERME

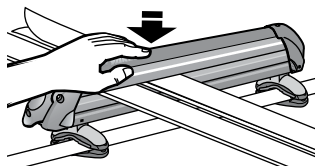

## 24 VÉRIFIER LA FERMETURE !

- Tirer la partie supérieure du porte-skis vers le haut pour voir si le porte-skis peut ouvrir.
- S'il ouvre, le refermer en appliquant cette fois-ci une pression plus grande.

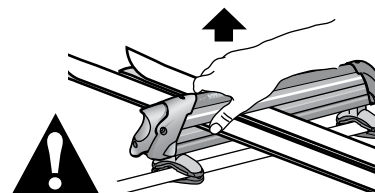

## 25 Poser les serrures SKS en suivant les instructions qui les accompagnent

- Les serrures s'achètent à part.
- TOUJOURS FERMER LES PORTE-SKIS AVANT DE LES VERROUILLER.

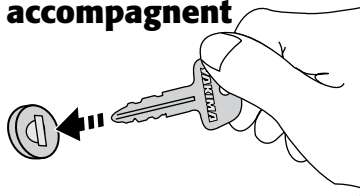

## HAYON

**TOUJOURS OUVRIR LE HAYON AVEC PRUDENCE.**

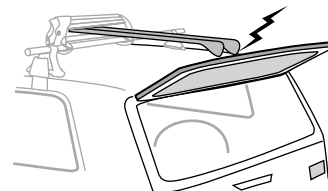

**VÉRIFIER QUE LES PORTE-SKIS SONT BIEN FERMÉS APRÈS CHAQUE MONTAGE ET AVANT DE PRENDRE LA ROUTE. Si l'on enlève le porte-skis, suivre les instructions pour le remettre en place.**



**ATTENTION : S'ASSURER QUE LE MONTAGE EST SOLIDE ET CONFORME AUX INSTRUCTIONS. LES DISPOSITIFS DE FIXATION PEUVENT SE DESSERRER À LA LONGUE. LES INSPECTER AVANT CHAQUE UTILISATION ET LES RESSERRER AU BESOIN.**

ENTRETIEN : lubrifier les boulons avec un lubrifiant non soluble à l'eau. Nettoyer les pièces en plastique avec un chiffon, de l'eau et un savon doux.

ENLEVER LES PORTE-SKIS ET LE PORTE-BAGAGES AVANT DE PASSER DANS UN LAVE-AUTO AUTOMATIQUE.

Pour que le produit dure plus longtemps, nettoyer et enlever le porte-skis à la fin de la saison.

**Ce produit est couvert par la garantie limitée « Tant que durera notre histoire d'amour » YAKIMA. Pour se procurer une copie de cette garantie, aller en ligne à [www.yakima.com](http://www.yakima.com) ou nous envoyer un courriel à [yakwarranty@yakima.com](mailto:yakwarranty@yakima.com) ou appeler au (888) 925-4621.**

**RENSEIGNEMENTS TECHNIQUES OU PIÈCES DE RECHANGE, prière de contacter votre dépositaire ou appeler au (888) 925-4621, du lundi au vendredi entre 7h et 17h, heure du Pacifique.**

**CONSERVER CES INSTRUCTIONS !**

# YAKIMA FreshSesh, PowderHound & Big PowderHound

ES

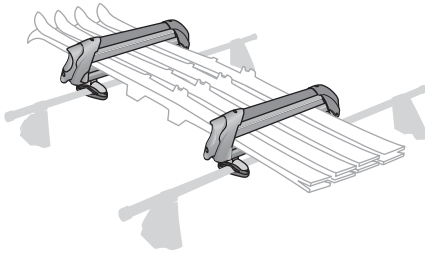

**PORTAEQUIPAJES (2)**

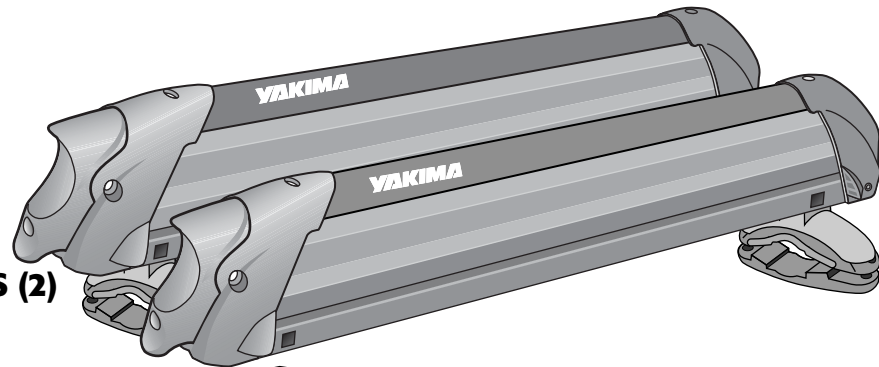

**Soportes de montaje universales (4)**

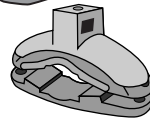

## ELEVADOR DE ESQUÍ (2)

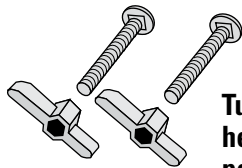

**Tuercas hexagonales con pernos (2)**

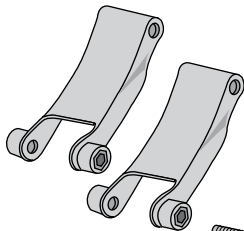

**Elevadores de esquís (2)**

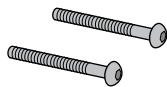

**Tornillos con cabeza redonda (2)**

## (PIEZAS DE LOS SOPORTES DE MONTAJE:)

Llave hexagonal (1)

Tornillos para base (4)

Topes deslizantes (4)

Tornillos de mordaza (8)  
*instalados*

Tornillos de mordaza largos (8)  
*para barras de fábrica más grande*

Mordazas superiores (4)

Tuercas cuadradas (4)  
Almohadillas (4)

Mordazas inferiores (4)

Almohadillas de vinilo (2)  
*para barras de fábrica*

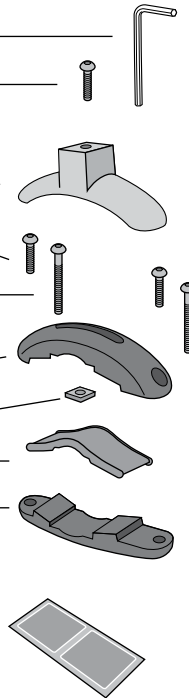

**AVISO IMPORTANTE: ES ESENCIAL QUE TODOS LOS PORTAEQUIPAJES Y ACCESORIOS DE YAKIMA ESTÉN INSTALADOS APROPIADAMENTE A SU VEHÍCULO. UNA INSTALACIÓN INADECUADA PODRÍA CAUSAR UN ACCIDENTE AUTOMOVILÍSTICO Y PRODUCIR LESIONES GRAVES O MORTALES A USTED U OTRAS PERSONAS. USTED ES RESPONSABLE DE SUJETAR BIEN EL PORTAEQUIPAJES Y LOS ACCESORIOS A SU VEHÍCULO, COMPROBAR LA INSTALACIÓN ANTES DEL USO Y EXAMINAR PERIÓDICAMENTE EL AJUSTE, GRADO DE DESGASTE O DAÑO DE LOS PRODUCTOS. POR LO TANTO, DEBERÁ LEER Y COMPRENDER TODAS LAS INSTRUCCIONES Y PRECAUCIONES QUE VIENEN CON EL PRODUCTO DE YAKIMA ANTES DE INSTALARLO O USARLO. SI NO ENTIENDE TODAS LAS INSTRUCCIONES Y PRECAUCIONES O NO TIENE NINGUNA EXPERIENCIA MECÁNICA NI ESTÁ BIEN FAMILIARIZADO CON LOS PROCEDIMIENTOS DE INSTALACIÓN, DEBERÁ HACER INSTALAR EL PRODUCTO CON UN INSTALADOR PROFESIONAL, COMO UN TALLER ACREDITADO.**

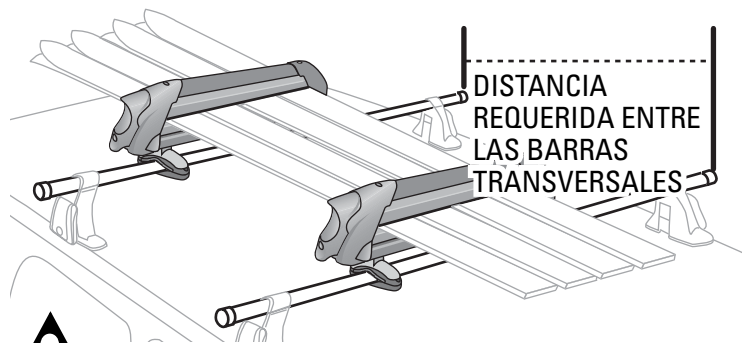

**ESQUÍS Y TABLAS HASTA 170 cm:**  
*La distancia entre las barras deberá ser entre 30 y 60 cm*

**ESQUÍS Y TABLAS MAYORES QUE 170 cm:**  
*La distancia entre las barras deberá ser entre 30 y 90 cm*



**TORRES Q YAKIMA: ¡NO REPOSICIONE SUS TORRES!**

**1**

**RETIRE EL TORNILLO PARA BASE**

Use la llave hexagonal.

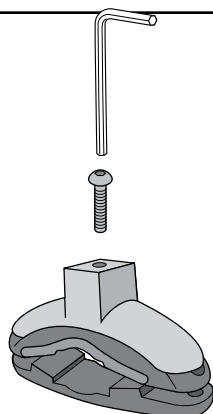

**2**

**RETIRE UN TORNILLO DE MORDAZA**

- Use la llave hexagonal.
- Afloje el tornillo restante pero déjelo en su lugar.

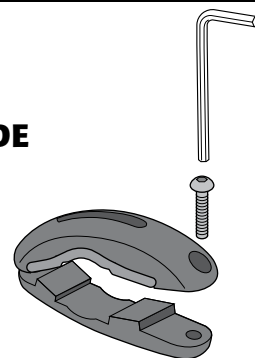

**3**

**BARRAS DE FÁBRICA: REVISE QUE EL LARGO DE LOS TORNILLOS SEA APROPIADO**

- Algunas barras de fábrica podrían necesitar los tornillos de mordaza largos.
- Los tornillos deben salir por debajo de la mordaza.

SI SON DEMASIADO PEQUEÑOS, UTILICE LOS TORNILLOS MÁS LARGOS PROVISTOS.

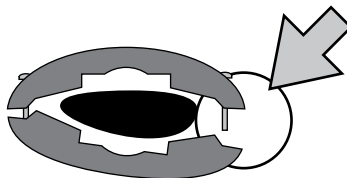
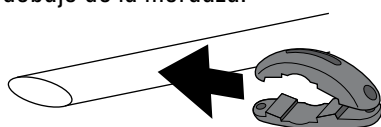

*En algunos casos, las mordazas podrían no quedar paralelas.*

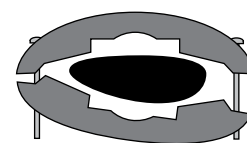

**correcto**

**4**

**TRABAJE EN UNA SUPERFICIE PLANA**

Abra el portaequipajes (se abre de dos maneras):

**LEVANTANDO LA PARTE INFERIOR DEL CIERRE...**

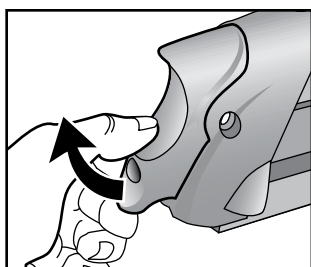

**PRESIONANDO LA PARTE SUPERIOR DEL CIERRE...**

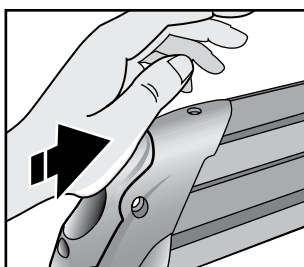

**ABRIR**

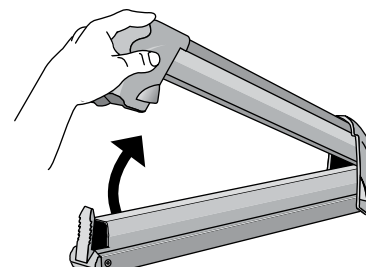

## 5 ENSAMBLE

- Inserte el tornillo para base a través del agujero en la almohadilla.
- Coloque el tope deslizante en el tornillo.

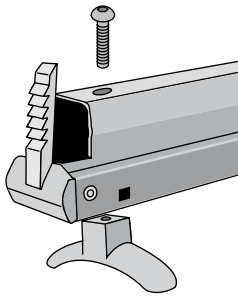

## 6 UNA LA MORDAZA SUPERIOR AL TOPE DESLIZANTE

- Alinee el tornillo para base con la tuerca cuadrada (dentro de la mordaza superior).
- Use la llave hexagonal para unir el tornillo y la tuerca.
- No ajuste todavía.

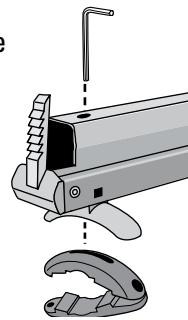

## 7 MUEVA LA UNIÓN ANTERIOR DE MANERA QUE LOS AGUJEROS DE LOS TORNILLOS QUEDEN EXPUESTOS.

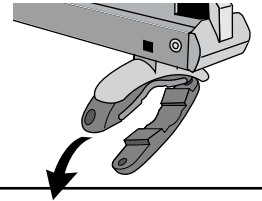

REPITA LOS MISMOS PASOS PARA EL HERRAJE RESTANTE

## 8 CIERRE EL PORTAEQUIPAJES PRESIONANDO CON FIRMEZA

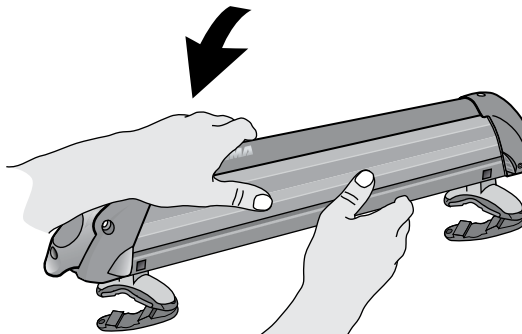

## 9 INSERTE EL SEGUNDO TORNILLO DE MORDAZA ÚNICAMENTE POR LA MORDAZA SUPERIOR.

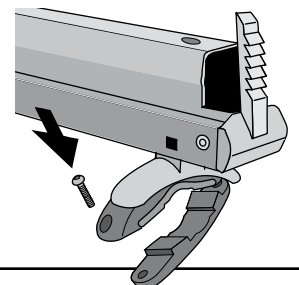

## 10 DESLICE EL MONTAJE DEL PORTAEQUIPAJES ALREDEDOR DE LA BARRA TRANSVERSAL

### BARRAS REDONDAS

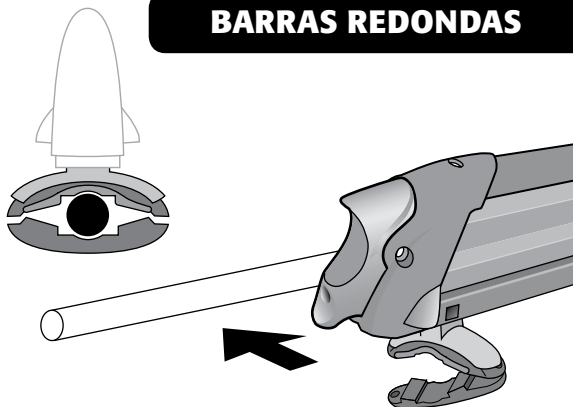

### BARRAS CUADRADAS

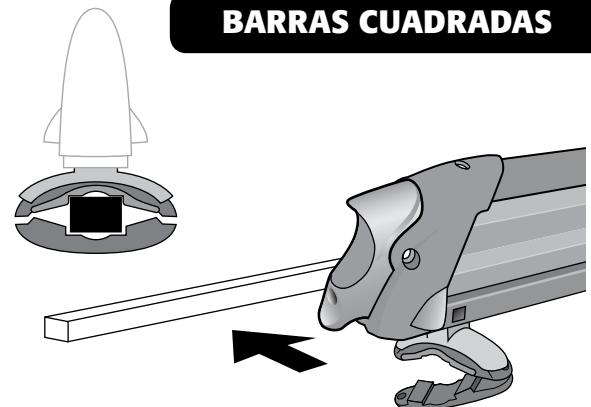

### BARRAS DE FÁBRICA

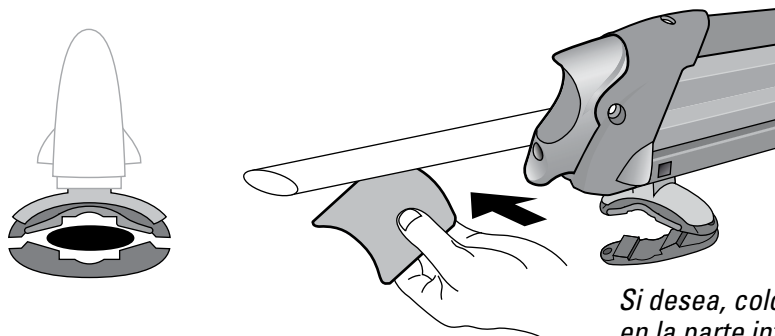

*Si desea, coloque almohadillas de vinilo en la parte inferior de las barras de fábrica para proteger su acabado.*

## 11 ASEGURE EL MONTAJE

- Deslice el portaequipajes para dejar expuestos los tornillos de mordaza no ajustados.
- Use la llave hexagonal para ajustar los **tornillos**.

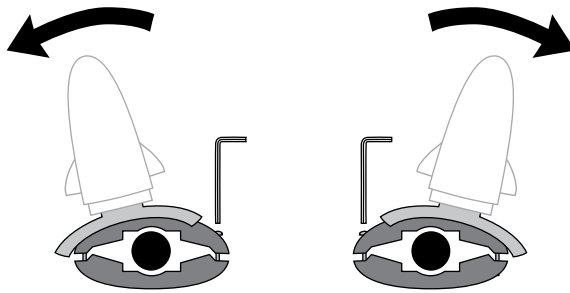

## 12 ABRA EL PORTAEQUIPAJES

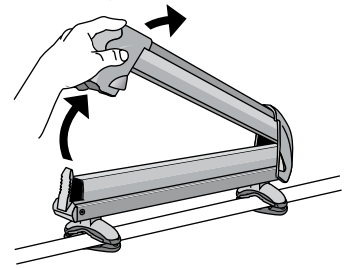

## 13 AJUSTE EL PORTAEQUIPAJES A LOS SOPORTES DE MONTAJE UNIVERSALES

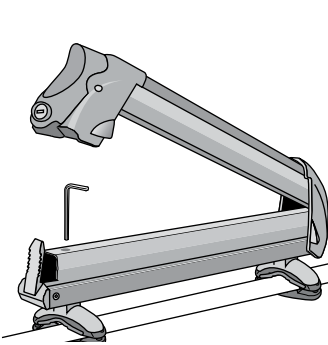

Cerciórese de que el portaequipajes esté alineado verticalmente.

En algunos casos, el soporte de montaje universal se apoyará en un ángulo.

## 14 CARGUE LOS ESQUÍ O LAS TABLAS DE SNOWBOARD CON LAS PUNTAS HACIA LA PARTE POSTERIOR DE SU VEHÍCULO

¡Baje sus fijaciones!

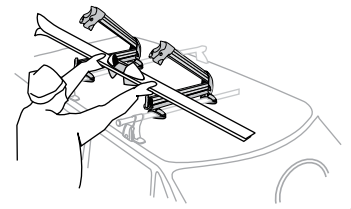

## 15 VERIFIQUE SI HAY ESPACIO PARA LAS FIJACIONES

Si tiene suficiente espacio, CONTINÚE EN EL PASO 23.

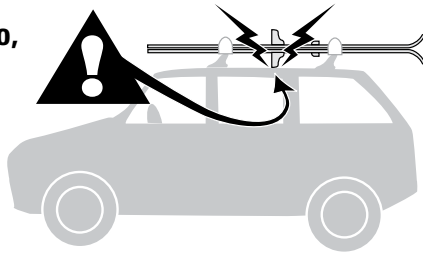

Si necesita más espacio o si las barras de fábrica están arqueadas y no pueden alinearse con el portaequipajes,

CONTINÚE EN EL SIGUIENTE PASO DÓNDE SE INDICA LA INSTALACIÓN DEL ACCESORIO TELESQUÍ.

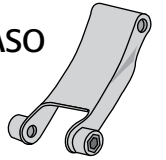

## 16 INSTALACIÓN DEL ELEVADOR DE ESQUÍ: ABRA EL PORTAEQUIPAJES

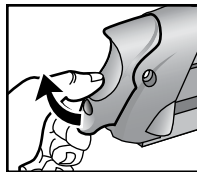
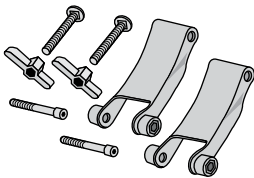

-0-

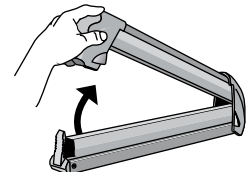
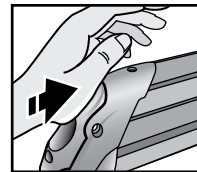

## 17 Retire el tornillo para base en el extremo con bisagra del portaequipajes.

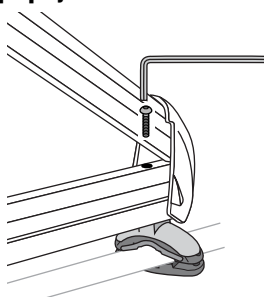

## 18 Afloje el tornillo para base delantero, sin retirar el tornillo.

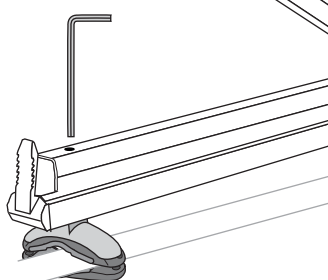

## 19 LEVANTE EL LADO CON BISAGRA DEL PORTAEQUIPAJES

Vuelva a colocar el tornillo para base en el herraje.

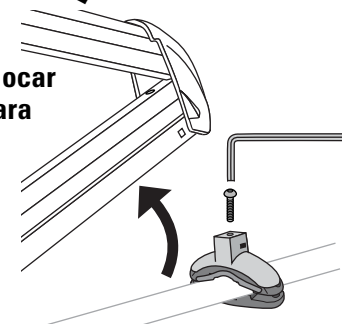

## 20 UNA EL ELEVADOR DE ESQUÍS AL SOPORTE DE MONTAJE UNIVERSAL

- Use los pernos con cabeza.
- Asegure los tornillos con la llave hexagonal.

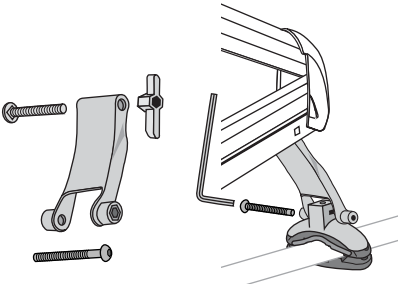

## 21 UNA EL TELESQUÍ AL PORTAEQUIPAJES

- Coloque los pernos y tuercas hexagonales y ajústelos.
- Afloje los tornillos de mordaza para reposicionar y ajustar mejor los soportes de montaje.

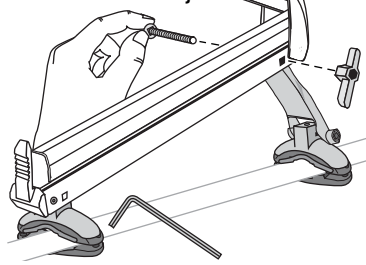

## 22 AJUSTE LOS TORNILLOS PARA BASE DELANTEROS

*Ajuste todos los tornillos de mordaza flojos para asegurar los soportes a las barras transversales.*

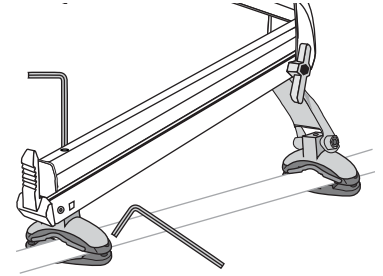

## 23 CIERRE EL PORTAEQUIPAJES PRESIONANDO CON FIRMEZA

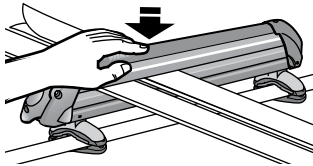

## 24 ¡VERIFIQUE QUE ESTÉ BIEN CERRADO!

- Tire hacia arriba la parte superior del portaequipajes para ver si éste se abre.
- Si se abre, presiónelo con más fuerza al cerrarlo.

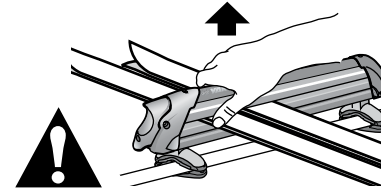

## 25 Instale el sistema de cerraduras con misma llave (SKS) siguiendo las instrucciones

- Las cerraduras se venden por separado.
- CIERRE SU PORTAEQUIPAJES ANTES DE ASEGURARLO CON LA LLAVE.

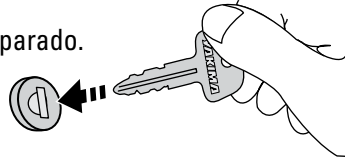

**PUERTAS TRASERAS SIEMPRE TENGA CUIDADO CUANDO ABRA LA PUERTA TRASERA DE SU VEHÍCULO.**

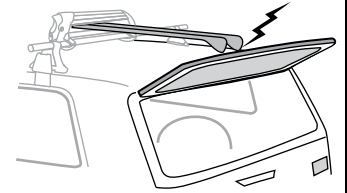

**VERIFIQUE EL CIERRE DEL MONTAJE DESPUÉS DE CADA INSTALACIÓN Y ANTES DE INICIAR SU VIAJE. Si retira el portaequipajes, siga las instrucciones para la reinstalación.**



**ADVERTENCIA: CERCÍOARSE DE QUE TODOS LOS HERRAJES ESTÉN ASEGURADOS SEGÚN LAS INSTRUCCIONES. CON EL TIEMPO, LOS HERRAJES DE SUJECIÓN PUEDEN AFLOJARSE. REVÍSELOS ANTES DE CADA USO Y AJÚSTELOS SI ES NECESARIO.**

**MANTENIMIENTO:** Use lubricantes no solubles en agua para los tornillos. Use un paño suave con solución jabonosa para limpiar las piezas de plástico.

RETIRE TODOS LOS PORTAEQUIPAJES ANTES DE ENTRAR A UN ESTABLECIMIENTO PARA LAVADO AUTOMÁTICO DE AUTOMÓVILES.

Para extender la vida del producto, limpie y retire el portaequipajes al final de la temporada.

Este producto está cubierto por la garantía limitada a vida mientras dure el romance de YAKIMA. Para obtener una copia de esta garantía, visítenos en [www.yakima.com](http://www.yakima.com), envíenos un correo electrónico a [yakwarranty@yakima.com](mailto:yakwarranty@yakima.com) o llámenos al (888) 925-4621.

**ASISTENCIA TÉCNICA O PIEZAS DE REPUESTO**  
Comuníquese con su distribuidor o llame al (888)925-4621, de lunes a viernes, de 7:00 a 17:00 horas, hora estándar del Pacífico.

**CONSERVE ESTAS INSTRUCCIONES**