

2008-09 Operator's and Assembly Manual

**RACKandROLL 66 Trailer
RACKandROLL 78 Trailer**



YAKIMA

Operator's and Assembly Manual

***Keep this Operator's Manual
in your glove box.***

**This manual is also a
guide for assembling
your trailer correctly.
Please follow the
steps carefully.**

To ensure your complete satisfaction and safety,
please read this entire manual. If you experience difficulty, contact
your trailer dealer. You may also contact us directly.

Due to a commitment to make continuous improvements, Yakima
reserves the right to change specifications or add or discontinue
models at any time without notice.

IMPORTANT: State Regulations and Insurance

Before installing any accessories and/or equipment, check regulations
in the states you plan on towing your trailer to be sure you are in full
compliance with these laws. Your dealer can help you or you can contact
each state's Department of Motor Vehicles. For example, state laws vary
on how far a kayak can extend off the rear of any trailer before requiring a
red flag during the day, and a marker light at night.



**Congratulations on
the purchase of your Yakima
RACKandROLL trailer.**

**With proper assembly and
maintenance, your trailer will provide
you with years of trouble-free freedom.**

YAKIMA

Table of Contents

Parts List and Trailer Diagram	2
Warnings and Towing Checklist	3
Required Maintenance (Lights, Nuts, Grease, Tires, Wheel Bearings, Spare Tire Mounting)	4
Hitch Information (Vehicle Hitch, Ball Mount, Coupler, Ball, Safety Chain)	5
Loading Gear (Weight Distribution, Attaching Gear, Max. Weight, WARNING)	6
Driving with a Trailer (Backing Up the Trailer, Warnings and Tips, Water Submersion, Hitch Noise)	7
Storing the Trailer / Wheel Removal	8-9
Optional Accessories	10
Replacement Parts	11
Warranty Information	12
Electrical System Requirements & Troubleshooting	13
Additional Information and Resources	14
Trailer Assembly - Assembly Tools Required and Layout	15
Install Cross-members & Wheel Blocks	16
Install Shock Pins & Wheels	17
Install License Bracket and Light	18
Install Center Rail - Check Light Plugs	19
Install Tongue & Flat-4 Connector	20
Install Crossbars	21



Parts List and Trailer Diagram

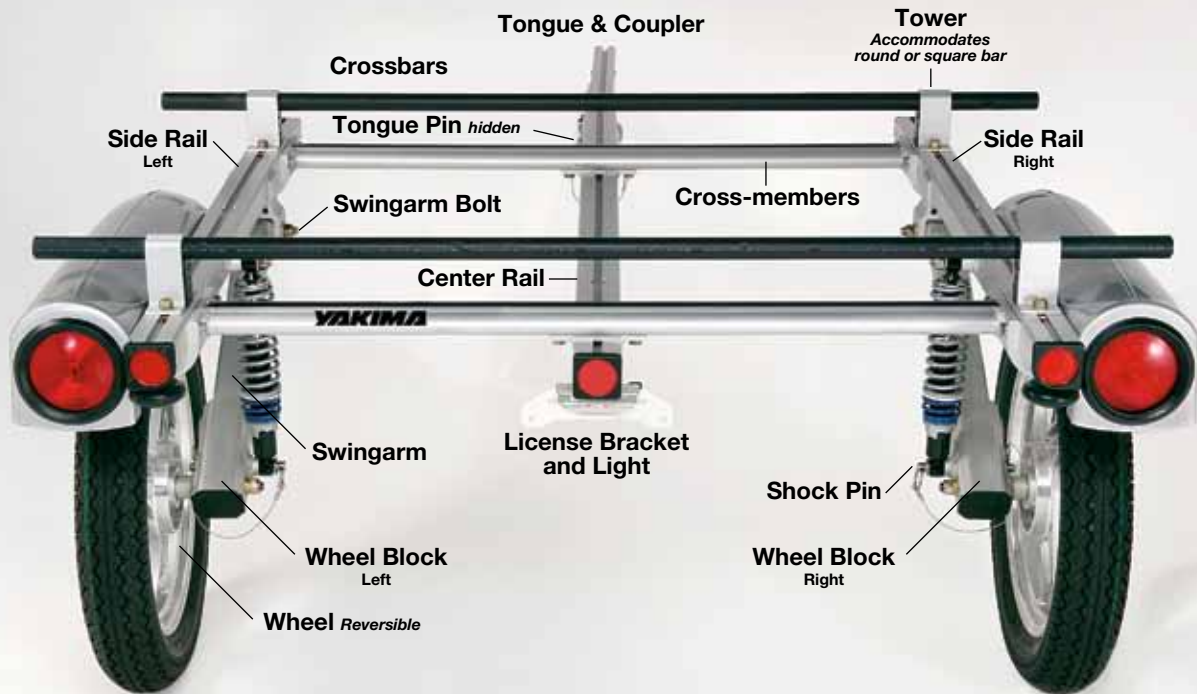

Warnings & Towing Checklist

Please read these and other warnings posted throughout this manual!

WARNING:

FOLLOW THE TOWING CHECKLIST on the yellow warning label on the trailer tongue. Go through the checklist in the same order every time **to avoid serious injury or death.**

Hooking up the trailer for use should be a carefully observed process that can not allow errors. See **REQUIRED MAINTENANCE** and follow before using your trailer.

WARNING: The maximum cargo load of the RACKandROLL 66 trailer is 250 pounds (113kg).

WARNING: The maximum cargo load of the RACKandROLL 78 trailer is 350 pounds (159kg) (with HD shocks only).

WARNING: Use with motorcycles is **NOT** recommended and can result in injury or death.

GEAR LOADED WITH A HIGH CENTER OF GRAVITY INCREASES THE POSSIBILITY OF A TRAILER ROLL-OVER IN CERTAIN SITUATIONS.

TOWING CHECKLIST

1. Make sure your ball mount and 1 $\frac{7}{8}$ " ball are secured to the tow vehicle and inspected by a qualified hitch system dealer. Check the ball mount pin and safety clip.
2. Make sure the trailer coupler is secure to the hitch ball and locked with your safety pin.
3. Attach the safety chain to the tow vehicle securely.
4. All three black levers (trailer tongue and wheels) must be closed and locked.
5. Check all three "bow-tie" cotter pins (tongue and wheels). Be sure they are locked per the yellow warning labels.
6. Verify that tongue weight is minimum 10-15% of total gross weight and adjust load if necessary. Also check that your load is balanced left to right.
7. Check that your load is secure – all connections (boat straps, bike clamps etc.) should be tight.
8. Check tire pressure – 32-40 psi (2.2-2.8 bar) cold (see tire sidewall ratings).
9. Check trailer lights with a helper: brake lights, turn signal, and running lights. Do not operate without working lights.
10. Check all nuts including the spare tire mount – see *REQUIRED MAINTENANCE*.
11. Never step on an unhitched trailer.
12. Never allow a person to ride on the trailer.



Required Maintenance

LIGHTING CONNECTORS:

Your lights must work to be safe and legal. The connectors can corrode and need occasional attention to keep your lights working and you safe. Keep a thin layer of dielectric grease on the connectors. Carefully remove any corrosion with a scraping instrument – turn the power off to not short out the system when greasing or cleaning.

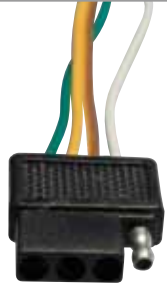

Flat-4 connector
from vehicle
(live terminals are
shielded, ground is not)

Check that the wire Plugs behind the Lights are securely in place. Check the taillights, side lights, and front lights. Make sure they are secured to lights and not loose – see pictures page 11. If the connectors come loose, clean the plug and light area, press the plug firmly into place, and apply hot-melt glue or similar adhesive along the edges. If you have questions, please call us.

Your trailer comes with a Flat-4 style connector for electrical connection to the tow vehicle. If your tow vehicle's connector is not a Flat-4 as shown above, you can buy an adapter.

NUTS & BOLTS: Periodically check to be sure they are secure.

NOTE: Use of a torque wrench is required.

- a. Wheel axle nuts (2) – torque to 57 ft. lbs. (77N-m) (a force of 57 lbs. on a 1 ft. lever.)
- b. Swingarm nuts (2) – torque to 31 ft. lbs (42N-m).
- c. Shock nuts (2) – torque to 31 ft. lbs (42N-m).
- d. Loadbar bracket nuts (8) – torque to 23 ft. lbs (31N-m).
- e. Spare tire mounting nut (1) – torque to 23 ft. lbs (31N-m).
- f. Cross-member to Side Rail bolts (16) – torque to 31 ft. lbs (42N-m).
- g. Center Rail to Cross-member bolts (4) – torque to 23 ft. lbs (31N-m).

GREASE REQUIRED: Keep the tongue pin and both wheel pins lightly greased or use a silicone-based lubricant. Keep the Wheel Blocks/Swingarm and Tongue/Frame mating surfaces lubricated. Keep the hitch ball greased.

The **wheel axle bolt must be greased** prior to installation or **it can prevent you from removing the wheel to fix a flat**. Simple corrosion can freeze the bolt. **Before any long trip**, as a precaution we recommend checking the bolts for removability and regreasing. Remember to take a Spare Tire.

TIRES: Keep your tires inflated to 32-40 psi (2.2-2.8 bar) (see tire sidewall ratings). Feel each tire at each gas stop, or break. A low tire will feel hotter, but there is no substitute for a tire gauge. The most common causes for tire failure are overloading and under inflation. Both cause excess sidewall flexing, heat build up, and eventual failure.

WHEEL BEARINGS: The wheel bearings are sealed and require no maintenance.

SPARE TIRE: An optional spare tire may be mounted above or below the trailer's Center Rail. Be sure to position the spare **no further back** than the center of the trailer's wheels. Check that the spare tire mounting nut is secure before using the trailer.

Hitch Information

VEHICLE HITCH AND BALL MOUNT

The vehicle hitch is the assembly installed on the tow vehicle. Typically, the ball mount (or draw bar) inserts into the vehicle hitch receiver and is secured with a locking pin. The hitch ball mounts to the ball mount. Ball mounts are available in various vertical height off-sets. Choose the proper offset to get the top of the ball 22" off the ground so your trailer tongue is parallel to the ground.

RACKandROLL trailers work with Class I, II, or III hitches when a size 1 $\frac{7}{8}$ " ball is securely provided. The Class I vehicle hitch carries the lightest rating with a maximum 200 lb. (91kg) tongue weight and 2000 lb. (907kg) towing weight and features a 1 $\frac{1}{4}$ " square receiver. A Class I vehicle hitch is more than adequate for the RACKandROLL trailer's light weight.

WARNING:

The proper distance from the ground to the top of the hitch ball is 22" (56cm) for your RACKandROLL trailer. Have a qualified vehicle hitch installer inspect your hitch before towing. Make sure your hitch has provisions for the connection of your safety chain.

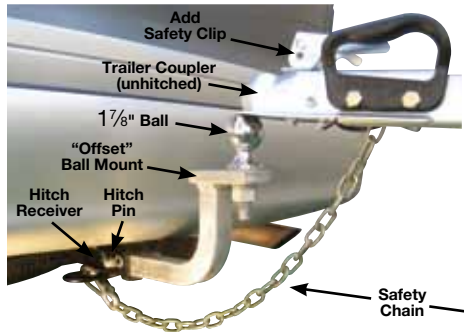

TRAILER COUPLER AND BALL

The trailer coupler features a ball clamp underneath the latch which tightens onto the ball when the latch is closed. The ball clamp has an adjustment nut (facing the ground). A little play is good, but tighten the nut to remove excess play if necessary. The coupler latch mechanism must be securely locked with your safety pin/padlock inserted. The ball should be lightly greased.

WARNING: Serious injury or death can result from the hitch ball not being properly secured and locked in the trailer coupler. You must use a 1 $\frac{7}{8}$ " ball size.

SAFETY CHAIN: Always attach the safety chain securely to the vehicle hitch. It must be long enough for tight turns and short enough to not drag on the ground. If the chain is too long, you can twist the chain (like winding up a rubber band) to make it shorter.

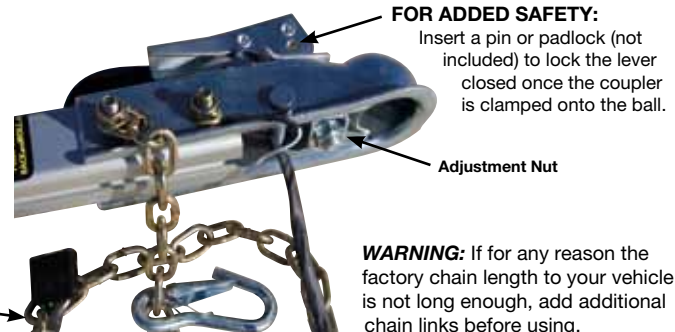

WARNING: If for any reason the factory chain length to your vehicle is not long enough, add additional chain links before using.

Loading Gear

MAXIMUM GROSS TRAILER WEIGHT

Your maximum gross trailer weight, or gross vehicle weight rating (GVWR) is 400 lbs. (181kg). This is the combination of the trailer's empty weight (approximately 150 lbs. (68kg)) and its maximum cargo weight of 250 lbs. (113kg). If your RACKandROLL 78 trailer model has the heavy-duty shocks (orange/blue color), your GVWR is 450 lbs. (204kg) with a maximum cargo weight of 350 lbs. (159kg).

WEIGHT DISTRIBUTION

A minimum of 10% to 15% of the total weight of the trailer and cargo should be on the tongue coupler. With your trailer loaded, place a bathroom scale under each wheel and under the tongue coupler. Add all three numbers for the total weight. Confirm that 10-15% of this number is on the tongue coupler. *(For example, a maximum load of 250 lbs. (113kg) results in a 400 lb. (181kg) total GVWR weight, so the tongue coupler should "weigh" 40-60 lbs. (18-27kg))* In general, 60% of your cargo weight should be forward of the wheels. You must also balance the weight from side to side. Adjust the load and/or the front-to-rear location of

WARNING:

GEAR LOADED WITH A HIGH CENTER OF GRAVITY INCREASES THE POSSIBILITY OF A TRAILER ROLL-OVER IN CERTAIN SITUATIONS.

Serious injury or death can also result if you load the trailer without enough weight on the tongue coupler; the trailer may fishtail and cause a loss of control of the tow vehicle. Long boats should be tied at the front to the tongue to keep boats from rocking.

the crossbars if necessary so the weight is centered and slightly forward on the trailer frame.

ATTACHING YOUR GEAR

Use Yakima® roof rack system hardware to attach gear to your RACKandROLL trailer crossbars. You can think of your trailer as a roof rack with its own wheels. Yakima round roof rack crossbars and square crossbars both fit your trailer.

Follow manufacturers' recommendations and instructions for the proper and safe attachment of your

accessories and gear.

Whether you want to carry kayaks, canoes, bicycles, or secure your gear in our aerodynamic boxes, you can take advantage of the world's most popular roof rack carrying systems and accessories from Yakima to meet your needs. If you carry a boat and accessories, make sure you meet applicable state regulations regarding using a red flag (day) and marker light (night) if the boat overhangs a given number of feet off the rear, as determined by the state(s) in which you travel.

Driving with the Trailer

BACKING UP THE TRAILER

WARNING: Because of its compact design, the RACKandROLL trailer may be difficult or impossible to see behind certain vehicles in certain conditions. You can damage your trailer and tow vehicle if you “jack-knife” the trailer backing up because you can’t see it. It is very easy to jack-knife a trailer if you can not see it to make corrections. Constantly check your left and right mirrors while backing up. Use a helper to guide you, or use our optional safety pole (page 10).

TIPS: If you can do so without injury, simply unhitch the trailer and reposition your tow vehicle where you want it and then reconnect the trailer.

When backing up, if you place your hand at the bottom of your steering wheel, moving your hand to the left will cause the trailer to go left, moving your hand to the right will make the trailer go right.

If you have never driven with a trailer, it’s a good idea to find a large space or empty parking lot and carefully and safely practice backing up and maneuvering.

WATER SUBMERSION

We do NOT recommend that you submerge the trailer in water.

However, your aluminum trailer features materials that offer a high degree of corrosion resistance. It is especially suited for salt-water environments to provide a long service life. The main frame is anodized aluminum. All major fasteners are stainless steel or yellow zinc plated, a notch up from standard zinc plating. The lights are all sealed units.

It is the electrical wiring connections, safety pins, and wheel axle bolts that are most subject to corrosion and potential malfunction from water and road conditions – see *REQUIRED MAINTENANCE*. Avoiding water submersion will reduce these issues and prevent water from sitting inside the frame members where wiring and connections are routed.

HITCH NOISE

Some vehicle hitches are noisy! This is typically from “slop” between the ball mount (on which the ball is mounted) and the hitch receiver on your vehicle. You can buy a special hitch pin that tightens up this play and reduces the noise. A loose coupler on the ball may also create noise (see page 5).

Storing the Trailer

WARNING: Never detach your trailer from your vehicle on a hill. When you unhitch the trailer, block the wheels to avoid injury and/or damage from a runaway trailer. Never step on an unhitched trailer.

STORAGE OPTION 1 – Tongue still attached. Don't try to stand your trailer up with the tongue in! You can only park it somewhere safe. Block the wheels (not pictured).

Storage Options 2-5 require removing the tongue: Leave the trailer attached to your vehicle if possible. Open the black lever, disconnect the wiring, and remove the Tongue Pin. Hold onto the tongue and the trailer at the same time. Push the trailer backwards to slide the tongue out (see pictures). Do NOT let the tongue fall into the ground as it may damage it so it won't fit back. Put the pin back in the tongue, remove the tongue from your hitch, set aside, and choose a storage option.

WARNING: DO NOT store the trailer in any upright position with the tongue in. It is unstable and can fall and cause damage and **serious injury or death.**

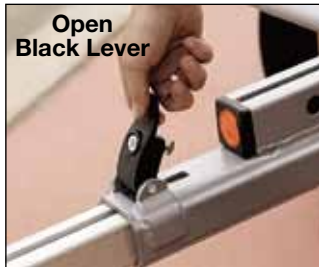

STORAGE OPTION 2 – No tongue. Tilt the trailer back onto its rear end (see picture).

STORAGE OPTION 3 – No tongue, wheels on. Roll the back of the trailer the right distance from the wall and tilt it up off its wheels and onto the rear endcaps. This takes some trial and error to get the angle right so the trailer is leaning safely and stable (see picture).

WARNING: When leaning the trailer against a wall, make sure your floor is flat and rough enough to prevent the trailer bottom from sliding out from the wall causing damage or injury. The trailer bottom can slip out and fall on a smooth floor. Adjust the angle to the wall for stability depending on whether your wheels are on or off and what hardware you may have on your crossbars.



Storing the Trailer, Wheel Removal

Storage Options 4-5 require removing the wheels: Lean the trailer back per Storage Option 3. Check that it's stable. Now unlock and open the black wheel block levers. Un-snap the bow-tie cotter pins and pull out the Shock Pins. Hold onto the Wheel and slip the Wheel and Wheel Block off the Swingarm (see picture). Reinsert the pins for safe keeping.

STORAGE OPTION 4 – No tongue, wheels off. Lean the trailer frame against a wall. It can be at a more vertical position than Option 3 with wheels on (see picture).

STORAGE OPTION 5 (not pictured) – No tongue, wheels off. You can hang the trailer frame on a wall by its Crossbars using properly rated brackets. You may or may not have to remove roof rack hardware from your Crossbars (not pictured).



ROLLING THE FRAME SIDEWAYS

The two small roller-blade wheels are designed to provide easy lateral rolling of the frame. You have to tilt and balance the frame just right to use them. Please be careful with the license plate when rolling the frame – it can hurt you (see picture)!

Winter Storage and Salt Water Environments

Use inside storage or a tarp if outside. Spray the steel parts (yellow zinc bolts and nuts, cotter pins etc.) with WD-40 or equivalent. See **Grease**, page 4.



Optional Accessories

KICKSTAND



Kickstand conveniently attaches to the Tongue. Keeps trailer level when un-hitched.

SPARE TIRE

Standard 5-Spoke
Wheel / Spare Tire



Carrying a Spare Tire is recommended for convenience and safety.

TONGUE EXTENSION KIT



Convert your Standard Tongue to allow for longer loads. Carry a single kayak of up to 22 ft. (6.7m) long or two 21 ft. (6.4m) kayaks.

SAFETY POLE

This 40" (102cm) tall bright yellow fiberglass safety pole attaches to the loadbar or trailer frame. Makes trailer more visible at all times and is especially useful for backing up.



Replacement Parts

LIGHTS

All of the lights are sealed units with recessed female plugs behind. Replacement lights are available throughout US and Canada from truck and auto parts stores and on-line. However, they may have a different style plug in the back. Take your old light for reference so your new light matches your trailer's male plugs. Or replacements can be ordered from us. Or buy the new light's matching male plug with wire (pigtail) and splice it into your trailer's wiring. Peterson (www.pmlights.com), Truck-lite (www.truck-lite.com), and Grote (www.grote.com) all manufacture compatible lights.

To remove the lights: The front amber "beehive" units feature a "bayonet mount." Facing the front of the light, carefully twist the amber lens counterclockwise about 90 degrees, grip firmly, and pull to remove. If it doesn't come out, turn it back and forth a little while pulling on it and work it loose. Don't keep rotating the light. Do not force.

The red lights snap out of their rubber grommet mounts. When replacing, be sure the light is fully seated in the grommet – they can appear to be installed without being fully seated.



TIRES

The factory tires are 3.25 x 16. They are rated for more weight than the trailer itself.



KEYS FOR BLACK LEVER LOCKS

We recommend that you write down your key code (stamped on each of the 6 keys provided) for safe keeping. Key codes begin with the letter "S" followed by three numerals. Contact Yakima for replacement keys.

YAKIMA

Warranty Information

We warranty RACKandROLL brand trailers and accessories to the original purchaser up to one (1) year from the date of the original retail purchase to be free from defect in materials or workmanship.

Subject to the exceptions noted below, Yakima will remedy defects in materials or workmanship during the warranty period by repairing or replacing (at Yakima's option) the defective component(s) without charge for parts or labor to the original purchaser. The purchaser will be responsible for providing proof of purchase and the cost of shipping component(s). Please contact us for shipping instructions.

No warranty is given for defects resulting from conditions beyond Yakima's control including, but not limited to, misuse, overloading, or non adherence to Yakima instructions or guidelines.

No warranty is given for defects caused by accidents or unlawful vehicle operation. No warranty is given for defects caused by the user's failure to properly secure cargo as recommended.

Repair or replacement of the defective Yakima product is the original purchaser's exclusive remedy under the warranty. All consequential and incidental damages are excluded under this warranty. Damage to the original purchaser's vehicle, their cargo, or to any other person or property is excluded.

Claims are limited to one year from the date of retail purchase. Some states do not allow the exclusion or limitation of incidental or consequential damages, or limitations on how long an implied warranty lasts, so the above limitations may not apply to you. This warranty gives you specific rights and you may have other rights, which vary from state to state.

INFORMATION ON THE RACKandROLL WARRANTY

If you have specific questions regarding RACKandROLL's warranty, please contact us at (888) 925-4621 and ask for warranty information, or write:

YAKIMA PRODUCTS, INC.
15025 SW KOLL PKWY.
BEAVERTON, OR 97006-6056
support@yakima.com

The RACKandROLL trailer is patented under U.S. Patent No. 7,059,626
RACKandROLL is a registered trademark of Yakima Products, INC.

Electrical System Requirements & Troubleshooting

Unless your tow vehicle's electrical system can deliver at least 8.7 amps* at 12v DC, the RACKandROLL trailer lights will work erratically and/or will blow fuses.

Even if you have a brand-new factory-installed hitch system on a new vehicle, you may need a powered converter (aka "Modulite" or "powered system") to provide the 8.7 amps required.

Electrical Troubleshooting: If your trailer lights are not working, you must determine if the problem is the trailer or insufficient amperage from your vehicle's hitch wiring.

Please call (888) 925-4621 and we will help you find and resolve any electrical problems or visit our website www.yakima.com.

For assistance in troubleshooting your vehicle wiring go to **www.etrailer.com** and find their article entitled "Troubleshoot Your Trailer Wiring" which can be found through their electrical department. This article also describes trailer wiring as well.

Basic Hitch Wiring Info: Most modern hitch systems have a wiring harness with a black box built into it called a *converter*. The *converter* splits the brake signal wire on the vehicle into the two separate wires that feed the left and right trailer brake/turn signals. Note: unlike your tow vehicle, your trailer's turn signal and brake lights use the same lightbulb and wire. A *Modulite* or

powered converter pulls power directly from the vehicle battery instead of drawing power from the vehicle wiring system, which is safer. This way the extra amps to power the trailer don't go through the expensive electrical components of the vehicle. More vehicles are using thinner gauge wire and require a *Modulite* for most trailers, simply to protect their wiring system.

Wire Color Coding: Your trailer's right side brake/turn signal lightbulb uses the solid green wire. The left side brake/turn signal lightbulb uses the solid yellow wire. The single brown wire in the tongue splits into two wires inside the Center Rail to feed the left and right side running lights (4 per side) plus the black wire to the license light. The trailer frame functions as the ground "wire" for each light.

*each running light is 1/2 amp and there are 9 of them with the license lamp for a total of 4.5 amps. The left and right brake/turn lights (red wire only at 4" taillight) are each 2.1 amps. So the two brake/turn lights pull 4.2 amps with brakes or 4-way flashers on. That's 8.7 amps with every light bulb turned on.

Additional Information & Resources

Go Online - www.etrailer.com is a good on-line retailer and helpful guide to the world of trailers. www.uhaul.com is also a good place to shop for information and products (including a glossary of terms).

Highly Recommended - The National Highway Traffic Safety Administration (NHTSA) has a brochure titled, *TOWING A TRAILER, BEING EQUIPPED FOR SAFETY* – available as a PDF download from their website at www.nhtsa.gov. Enter the word “trailer” in their search box and you’ll find it. To get the downloadable PDF version, you can also go to this address: <http://www.nhtsa.dot.gov/cars/problems/Equipment/towing/Towing.pdf>

REPORTING SAFETY DEFECTS

If you believe that your RACKandROLL product has a defect which could cause a crash or could cause injury of death, you should immediately inform the National Highway Traffic Safety Administration (NHTSA) in addition to notifying Yakima Products, INC.

If NHTSA receives similar complaints, it may open an investigation, and if it finds that a safety defect exists in a group of vehicles, it may order a recall and remedy campaign. However NHTSA cannot become involved in any individual problems between you, your dealer, or Yakima Products, INC. You may also obtain other information about motor vehicle safety from the hotline number below.

To contact NHTSA you may either call the Auto Safety Hotline toll-free at 1.800.424.9393 (202.366.0123 in Washington, DC area) or write to:

NHTSA
U. S. Department of Transportation
400 7th Street SW, (NSA-11)
Washington, DC 20590

Canadian Customers who wish to report a safety defect to the Canadian government should write to:

Transport Canada
Defect Investigations
2780 Sheffield Road
Ottawa, Ontario, K1B 3V9
or call 1.800.333.0510

Assembly Tools Required and Layout

You will need the following tools:

- Socket wrench and sockets
- 22mm wrench or min. 8" adjustable wrench
- 21mm wrench or min. 8" adjustable wrench
- 17mm closed-end wrench or socket
- 16mm closed-end wrench or socket
- Torque wrench (recommended)
- #2 Phillips screwdriver
- 5mm Allen wrench
- Tape measure



Tighten all nuts and bolts to proper specifications.

Periodically check and tighten hardware to avoid serious injury or death.



Unpack your trailer from the shipping boxes. For ease of assembly, we suggest laying the parts out upside-down, unlike the photo above which shows the parts right side up. You need an area measuring about 12' x 12' (3.7m x 3.7m). We recommend assembling your trailer on carpet or similar surface to reduce scratching the trailer or fenders. **Leave the plastic on the fenders** until you're done.

Install Cross-members & Wheel Blocks

INSTALL CROSS-MEMBERS

The Cross-members hold the trailer together. They have wiring for the lights inside which is color coded.

Locate the bag of hardware marked “Frame Bolts” which includes the hex-head frame bolts, lock washers and flat washers.

With trailer upside-down (not right-side up as shown on page 15), install the **front** Cross-member first. It has two colored wires with black plugs coming out of each end and no RACKandROLL label. Place the front Cross-member up against the Side Rail (picture **6A**). Now, with lock washer and flat washer slipped onto bolt, LOOSELY thread all 8 front hex-head bolts into the Side Rail (picture **6B**). Do not use a

wrench if possible. Allow all bolts to have enough play to find their holes without “crossing the threads.”

Now install the **rear** Cross-member (YAKIMA label faces to rear). It has a single black wire out one end. Again place the Cross-member up against the Side Rail (picture **6A** and **6B**). Now LOOSELY thread all 8 rear bolts into the Side Rail.

You can now tighten all 16 bolts using a 16mm wrench to 31 ft. lbs. (42N-m). This is 31 lbs. of force on a 1 ft. lever. (picture **6C**) Use of torque wrench is preferred.

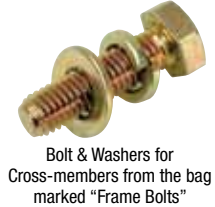

INSTALL WHEEL BLOCKS

Lift and release the Swingarm to check for “play.” If the Swingarm doesn’t stay up by itself, please tighten the Swingarm bolt until it does (picture **7A** on page 17).

There is a right and a left Wheel Block. Picture **7A** shows the trailer’s left Wheel Block (trailer upside-down). Picture **7E** shows the trailer’s right Wheel Block (trailer right-side up).

Note: the hole farthest to the rear on the Wheel Block has a “boss” (next to black endcap) that must face to the outside.

Lift up the Swingarm and lightly grease the ends. With the Black Lever open (picture **7A**), slide the correct Wheel Block on to the Swingarm.

6A Cross-member aligned for frame bolts

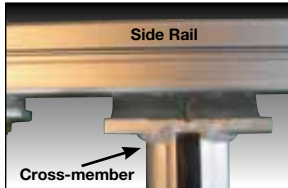

6B hand tight 16 bolts before wrenching



6C Tighten 16 bolts to 31 ft. lbs. (42N-m)



Install Shock Pins & Wheels

INSTALL SHOCK PINS

Apply some grease on both Shock Pins. These are the two large pins with the “bow-tie” cotter pins attached. Line up the shock absorber eye with the front Wheel Block hole (Inside Boss picture 7A) and insert the Shock Pin into the shock first, and then the Inside Boss hole.

If the Shock Pin does not go in easily, do not hammer it in. Note the black Shock Pin Alignment Screw on the Swingarm (picture 7B). If necessary, adjust screw so when Wheel Block hits it, the Shock Pin holes are lined up for it to go in easily. If the screw sticks out too far, it will prevent the Shock Pin from going in without damage. Please confirm Shock Pin Alignment Screw settings and adjust if necessary.

Install both Wheel Blocks with greased Shock Pins. Then attach and lock the “bow-tie” cotter pins (attached to lanyard) per the yellow warning label, **to avoid serious injury or death.** Close and lock black levers.

7A Levers open on left Wheel Block, rear hole boss to outside

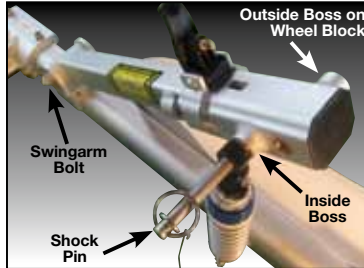

7B Shock Pin Alignment Screw



7C Grease Wheel Axle Bolt before and after insertion



7D Flat washer, lock washer, nut



7E Tighten to 57 ft. lbs. (77N-m), right Wheel Block shown



INSTALL WHEELS

Decide which side of the wheel you want facing out. Since they're reversible, you can select either a clockwise or counter-clockwise twist to the spokes.

Take the large Wheel Axle Bolts and slide on the largest flat washer. Put grease on the bolts and install through the wheel hubs. **Now grease the bolt A SECOND TIME** (picture 7C).

Lift the wheel and slide the bolt through the Wheel Block. Install the remaining flat washer, lock washer, and nut (picture 7D). **Tighten to 57 ft. lbs (77N-m).** (57 lbs. on a 1 ft. lever) (picture 7E). Install the hubcaps. They snap on and can be pried off with a flat screwdriver in the slot.

Your tires should be inflated to 32-40 psi (2.2-2.8 bar) cold (see tire sidewall ratings). Test with a tire gauge and periodically check for your safety. A Spare Tire is available as an option. It mounts above or below the Center Rail with mounting hardware (included).

Install License Bracket and Light

Lay the Center Rail flat on its mounting brackets and lay out the parts as shown. Per picture **8A**, parts are counter-clockwise from upper left in order of assembly:

- (1) License Bracket
- (4) Small screws to attach License Bracket to Center Rail (hard to see in photo)
- (1) Grey Light Base
- (2) Screws to attach Grey Light Base to License Bracket
- (1) Black rubber Plug
- (1) White Light
- (1) Center Rail

Screw License Bracket to Center Rail with 4 small screws (picture **8B**). Use screwdriver – a cordless drill can damage screws and holes.

Insert black rubber Plug (socket holes up) into bottom of Grey Light Base (picture **8C**).

Screw Grey Light Base to License Bracket with 2 screws by hand (picture **8D**).

Snap White Light into the Grey Light Base (picture **8E**). Note grey face of light faces rear. Connect black wire on light to wire from Center Rail and tuck excess wire back into the frame.

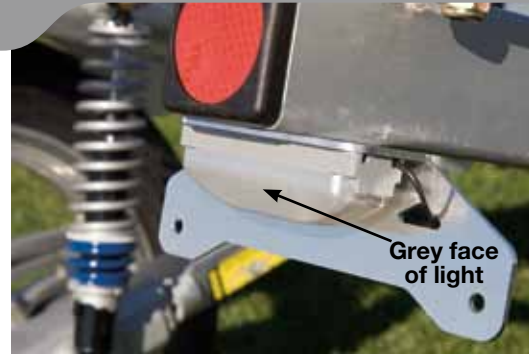

License Bracket & Light installed

8A Lay out parts

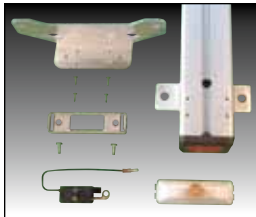

8B Screw on License Bracket

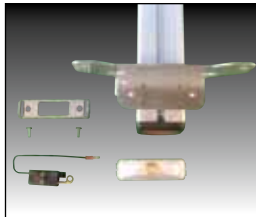

8C Insert plug into grey base

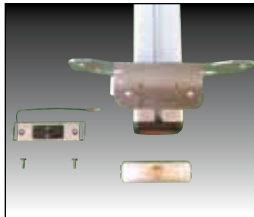

8D Screw on grey base

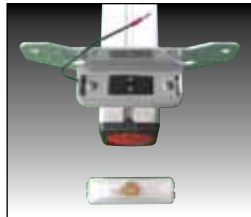

8E Snap on Light

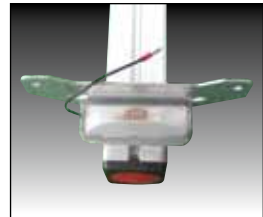

Install Center Rail - Check Light Plugs

Place Center Rail on top of Cross-members as shown (picture 9A).

From the bag of bolts marked "T-Bolts," insert two T-Bolts into the bottom of each Cross-member. Insert one at each end through the enlarged slots at the ends of Cross-members (picture 9B).

Line up the T-Bolts from each side and lower the Center Rail Brackets over the 4 bolts (picture 9C).

With the Center Rail brackets over the 4 bolts, install flat washers and 17mm nylock nuts. Before tightening nuts, use a tape measure to make sure Center Rail is centered between Side Rail. **Tighten (4) nuts to 23 ft. lbs. (31N-m)** (picture 9D).

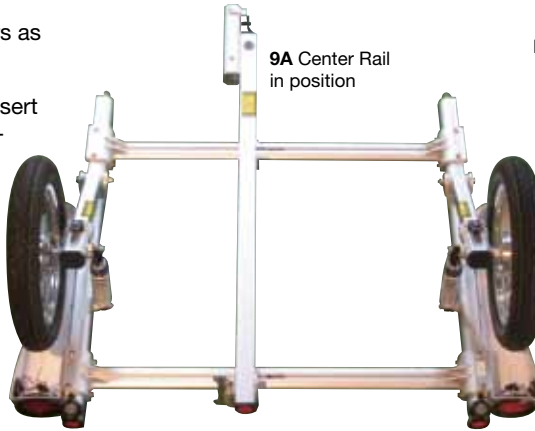

9A Center Rail in position

T-Bolt,
Flat Washer and
Nyloc Nut



Check Light Plugs: Check the plugs for the taillights, side lights, and front lights. Make

sure they are secured to lights and not loose – see pictures page 11. If the connectors have come loose during shipping, please press them firmly back into place. See page 4.

Connect (4) Deutsch Male/Female Electrical Connectors.

See picture 9E (Center Rail) and 9F (Side Rail).

9B T-Bolts inserted



9C Line up T-Bolts

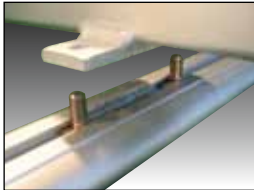

9D Tighten to 23 ft. lbs.



9E Center Rail Connectors Mated

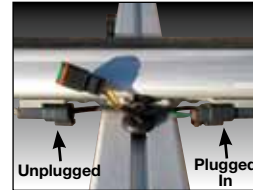

9F Side Rail Connectors Mated



Install Tongue & Flat-4 Connector

INSTALL TONGUE

Carefully turn the trailer right-side up onto its wheels.

Open the black lever on the tongue receiver (picture 20A).

Assembly Tip: Hook up the tongue ball coupler on to your vehicle hitch ball to hold that end up.

Lightly grease the end of the tongue and put a small amount of grease on the Tongue Pin. Insert the tongue flush with the rear of the receiver (push the Flat-4 wire in first – picture 20A).

Insert the Tongue Pin **with the black lever still open** (picture 20B). Install the “bow-tie” cotter pin (attached to the lanyard) in its locked position per the yellow warning label, **to avoid serious injury or death**. Close the black lever and lock all levers to prevent theft (picture 20C).

CONNECT WIRING

Plug in the Flat-4 electrical connector as shown (picture 20D).

20A Insert Tongue

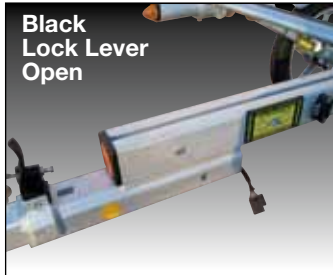

20B Insert Tongue Pin

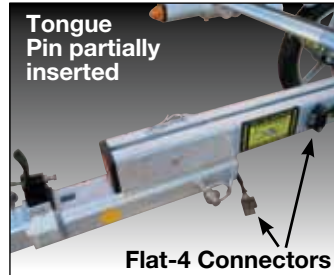

20C Clip on Bow-Tie

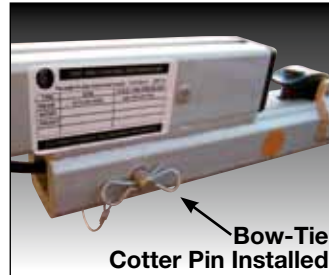

20D Connect Wiring

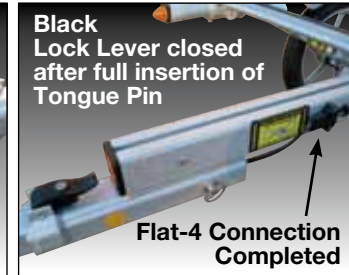

Install Crossbars

Slide four (4) T-Bolts into each of the Side Rails as shown.

Place the Black Blocks as shown – roughly in line with the Cross-members (or where you need them for your intended use with or without roof rack hardware). Make sure they end up positioned to place more weight in front of the wheels than behind. You need 10-15% of gross weight on the end of the tongue at the hitch.

Place the Round Crossbars on top of the Black Blocks. Use tape measure to center them left to right.

Slide the aluminum Towers over the Round Bar. Line up with the Blocks.

Install the flat washers and 17mm nylock nuts and **tighten to 23 ft. lbs (31N-m)**.

The Towers and Block assembly can accommodate both the Yakima® Round Crossbars, or Square Crossbars.



T-Bolts in Side Rail



Position Block with Crossbar on top. Slip Tower over T-Bolts. Attach washers and nuts.

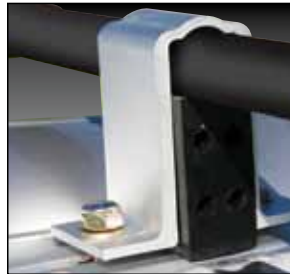
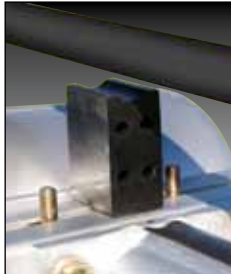

Tighten to 23 ft. lbs (31N-m).



YAKIMA

Yakima Products, INC.

Customer Service

15025 SW Koll Pkwy.
Beaverton, OR 97006-6056

- 1) Call us at 888-925-4621 from 7am-5pm Pacific Time M-F.
- 2) Email us: support@yakima.com.
- 3) Click on "Support" at the top of this page, then click "Ask a Question".

www.yakima.com

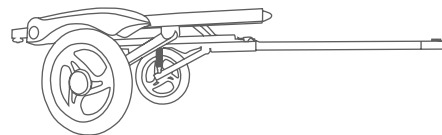
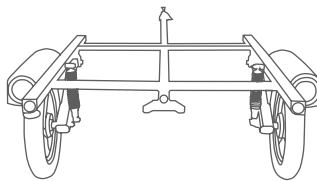
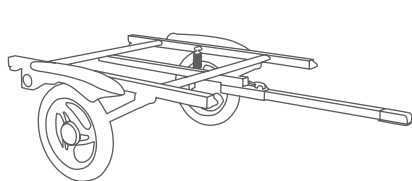

The RACKandROLL trailer is patented under U.S. Patent No. 7,059,626

Part #1033557 Rev.D