

YAKIMA

Q TOWERS

BY THE PAIR

US

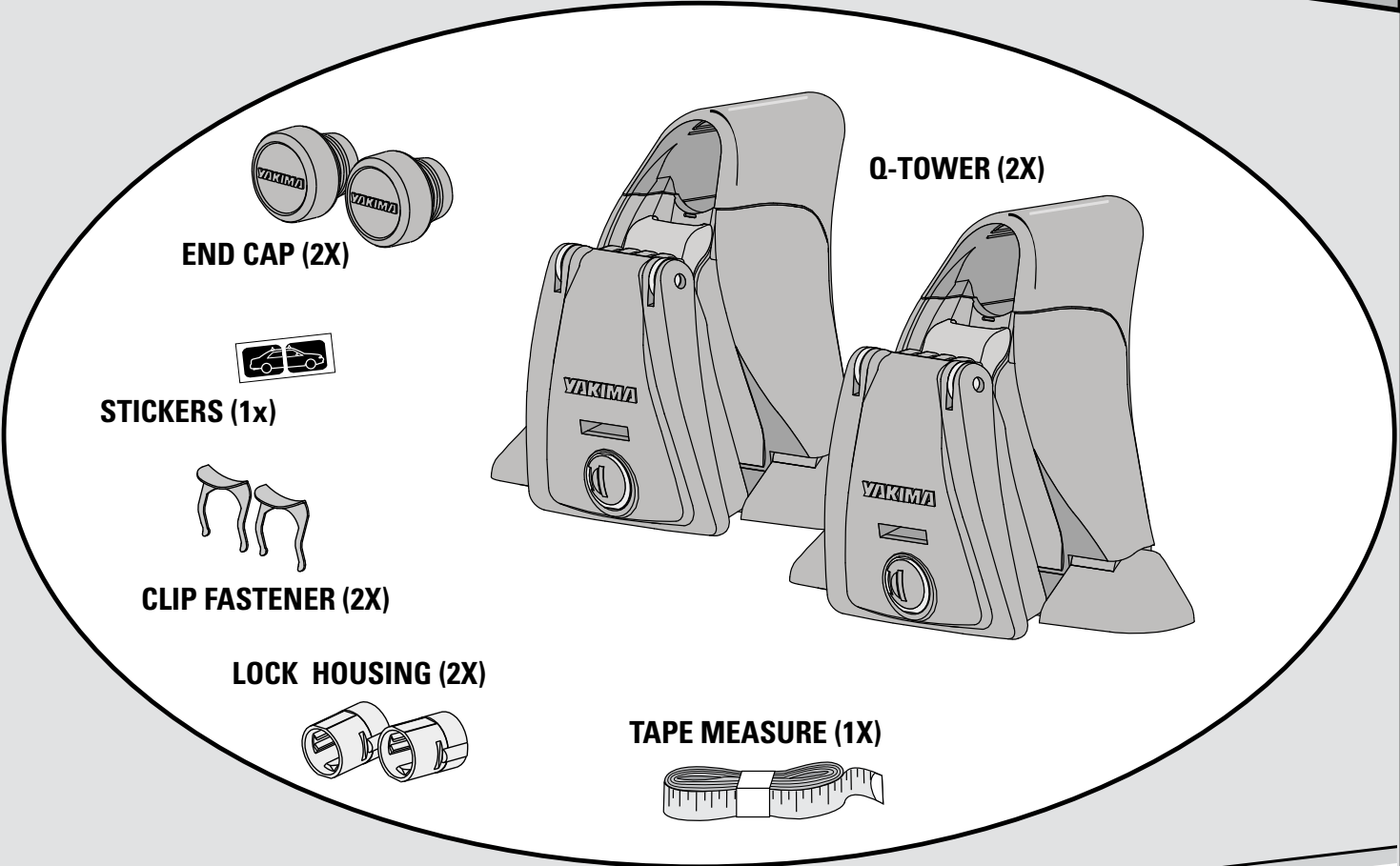

END CAP (2X)



STICKERS (1x)



CLIP FASTENER (2X)

LOCK HOUSING (2X)

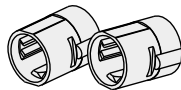

TAPE MEASURE (1X)

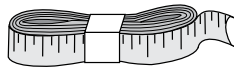

Q-TOWER (2X)

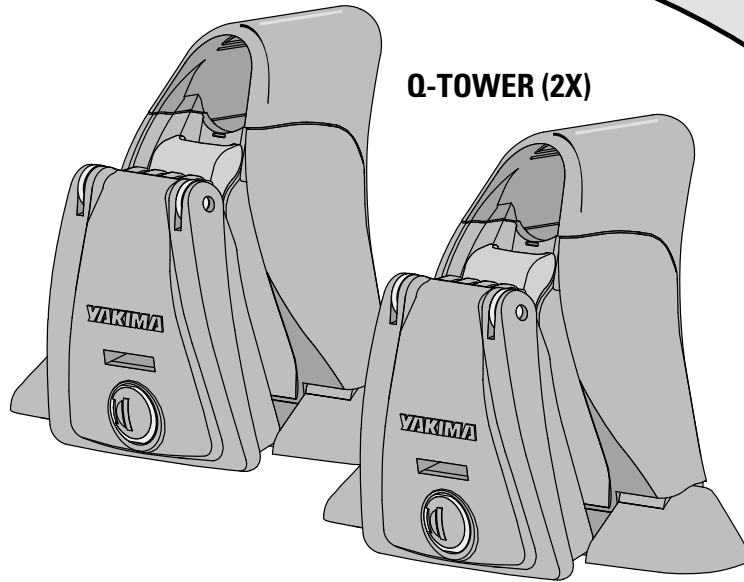

Vehicle-specific Q-Clips and crossbars are sold separately in pairs.

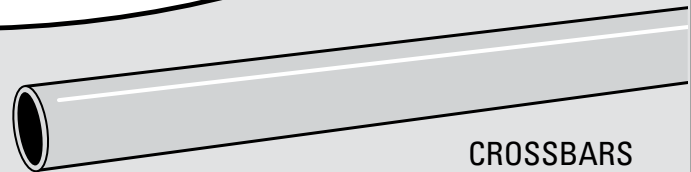

CROSSBARS



VINYL PADS

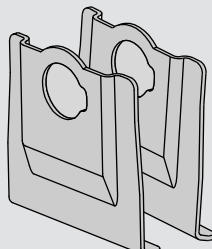

Q-CLIPS

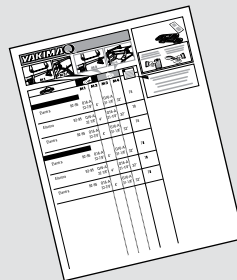

CLIP SHEET

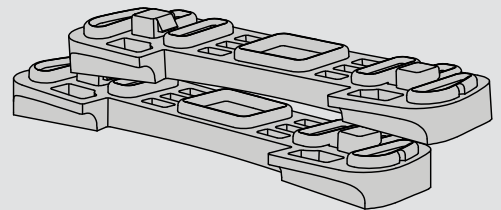

BASE PADS



IMPORTANT WARNING

IT IS CRITICAL THAT ALL YAKIMA RACKS AND ACCESSORIES BE PROPERLY AND SECURELY ATTACHED TO YOUR VEHICLE. IMPROPER ATTACHMENT COULD RESULT IN AN AUTOMOBILE ACCIDENT, AND COULD CAUSE SERIOUS BODILY INJURY OR DEATH TO YOU OR TO OTHERS. YOU ARE RESPONSIBLE FOR SECURING THE RACKS AND ACCESSORIES TO YOUR VEHICLE, CHECKING THE ATTACHMENTS PRIOR TO USE, AND PERIODICALLY INSPECTING THE PRODUCTS FOR ADJUSTMENT, WEAR, AND DAMAGE. THEREFORE, YOU MUST READ AND UNDERSTAND ALL OF THE INSTRUCTIONS AND CAUTIONS SUPPLIED WITH YOUR YAKIMA PRODUCT PRIOR TO INSTALLATION OR USE. IF YOU DO NOT UNDERSTAND ALL OF THE INSTRUCTIONS AND CAUTIONS, OR IF YOU HAVE NO MECHANICAL EXPERIENCE AND ARE NOT THOROUGHLY FAMILIAR WITH THE INSTALLATION PROCEDURES, YOU SHOULD HAVE THE PRODUCT INSTALLED BY A PROFESSIONAL INSTALLER.

Part# 1033430 Rev.H

Overview

Prepare for installation

Install towers in front

Install towers in rear

Perform safety checks

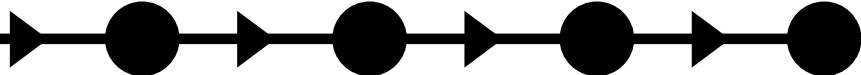

Anatomy of the Q-Tower.

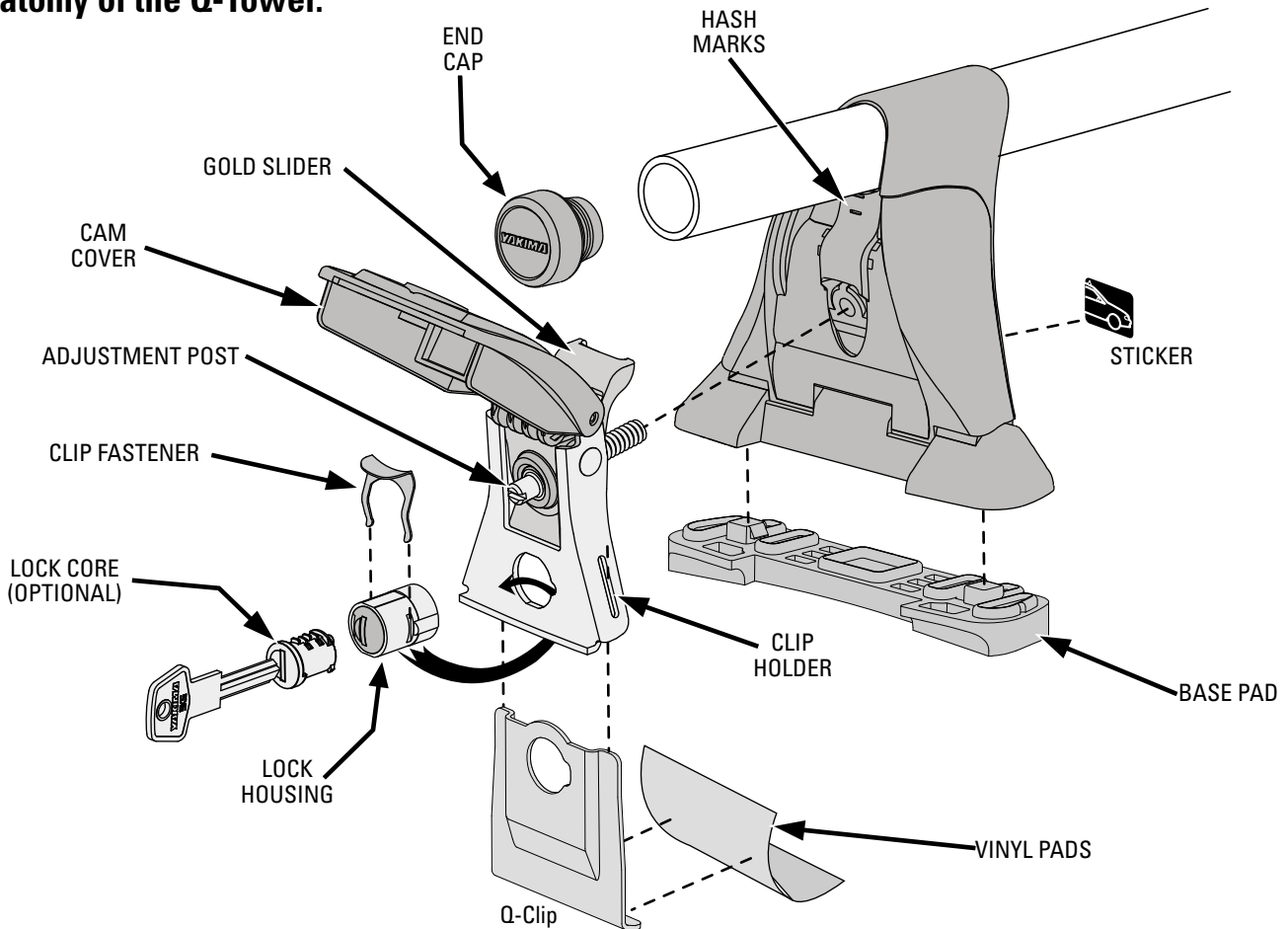

Q-Clip families.

There are several shapes and sizes of Q-Clips, but they all fall into five Q-Clip categories. Every vehicle needs a specific Q Clip to install Q-Towers. For this reason Q-Clips must be purchased separately. Examples of the five different categories of Q Clips are depicted below.

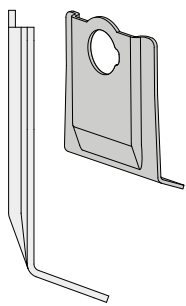

BLADED

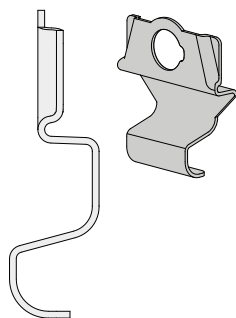

AIRCRAFT

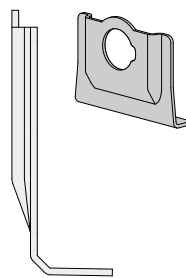

RAIN GUTTER

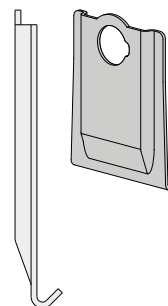

HOOK

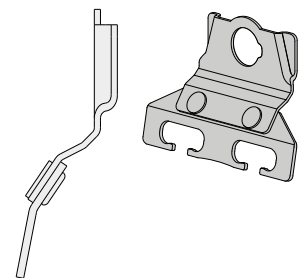

OEM
(ATTACHES TO FACTORY
INSTALLED VEHICLE FEATURE)

Overview

Prepare for installation

Install towers in front

Install towers in rear

Perform safety checks

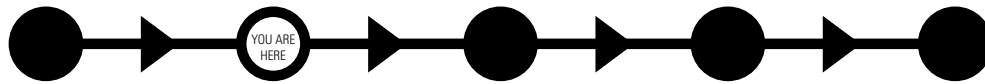

1 Remove the covers.

Unscrew the *adjustment posts* to remove the *covers* from each tower.

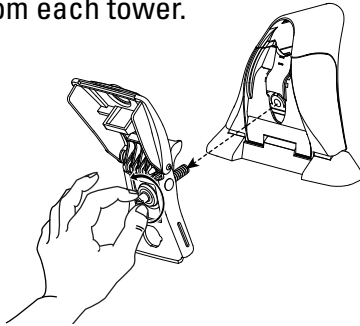

2 Open towers.

Open each tower to access the *tower screw*.

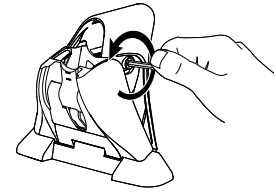
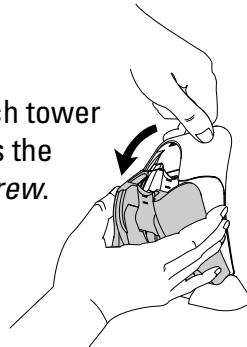

Loosen tower screws until the crossbar can fit through the tower (refer to next step).

3 Slide towers onto bars.

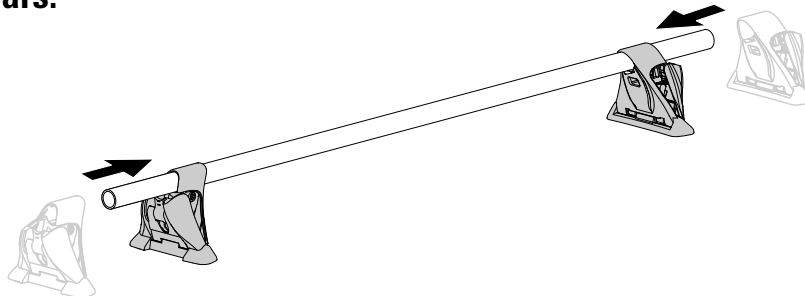

4 Find Your 4 M's (measurements).

Locate the precise measurements for your vehicle on the Q-clip sheet.

MAKE	M1	M2	M3	M4

Write down your four measurements in the spaces provided to the right. Keep these instructions in a safe place for future reference.



If your vehicle is not listed or the clip sheet is not in the Q-Clip box check yakima.com/roof-rack-installation, contact your dealer or call 888-925-4621.

YOUR Vehicle:

M1= _____

M2= _____

M3= _____

M4= _____



Will you be installing your Q-Tower pairs on the **FRONT** or on the **REAR**?
For **FRONT** installation continue below. For **REAR** installation skip to step 11.

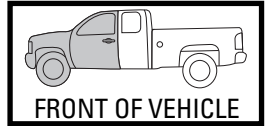

FRONT OF VEHICLE

5 Set M1 and center bar.

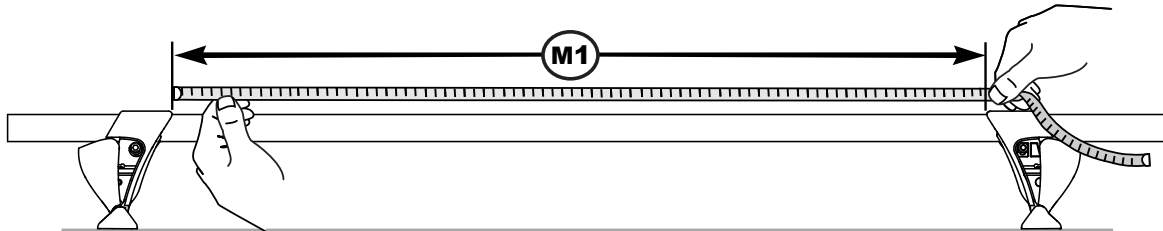

Note: Set measurements on a flat surface away from vehicle.



Pull the measuring tape tight to ensure accurate measurements. Measurements must be accurate to within 1/8" (3.2 mm).

TIP: To center crossbar between towers after setting your measurement use this technique. While pushing downward and rotating the crossbar, adjust the crossbar as needed to the left or right. Double check your M1 measurement and adjust if necessary.

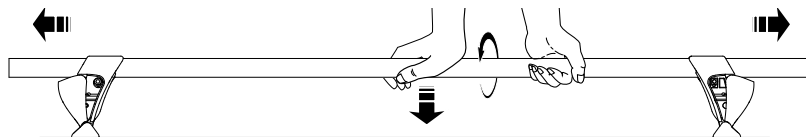

6 Tighten tower/bar assembly.



Be sure to not move the towers.

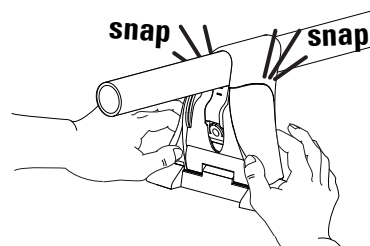
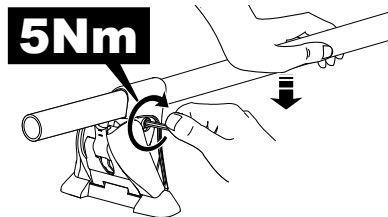

Snap the covers shut.

7 Label the towers.

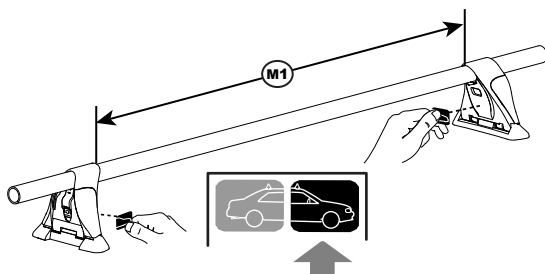

Label towers with front of vehicle stickers.

8 Install end caps and correct pads.

Attach correct pads. Some vehicles require different pads on front (M1) and rear (M3). Pad letter is located in the center of each pad.



Keep the pads clean and free of debris. Clean pads as necessary, and keep them clean by not setting them on a dirty surface.

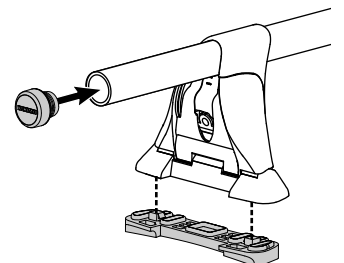

Overview

Prepare for
installation

Install towers
in front

Install towers
in rear

Perform safety
checks

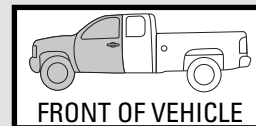

9 Position Towers in Front.

- Clean vehicle roof where towers will set.
- Set the assembly on the roof.

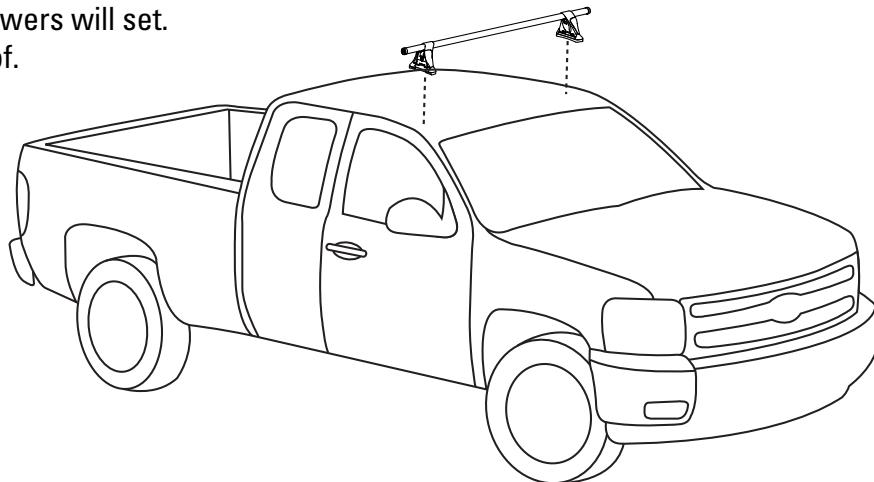

10 Set M2.

- USE THE M2 MEASUREMENT you identified in step 4.
- Measure the shortest distance from leading edge of tower base to nearest painted roofline corner.
- Once positioned DO NOT MOVE.

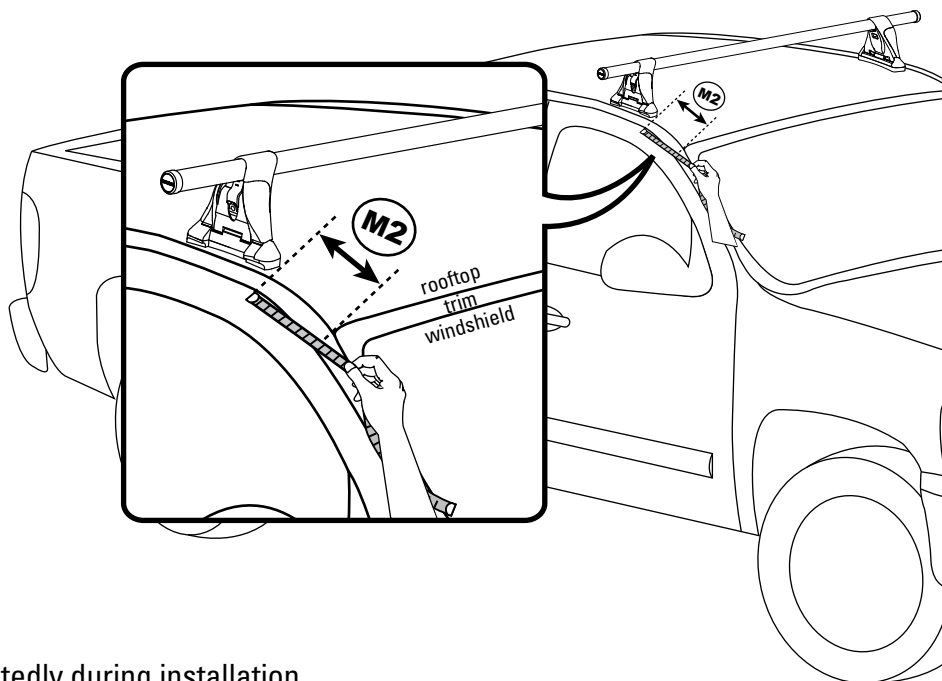

TIP: Verify this measurement repeatedly during installation.

To continue front tower installation skip to step 17.



Will you be installing your Q-Tower pairs on the **FRONT** or on the **REAR**?
For **REAR** installation continue below. For **FRONT** installation skip to step 5.

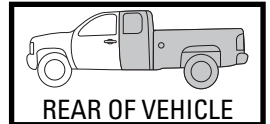

11 Set M3 and center bar.

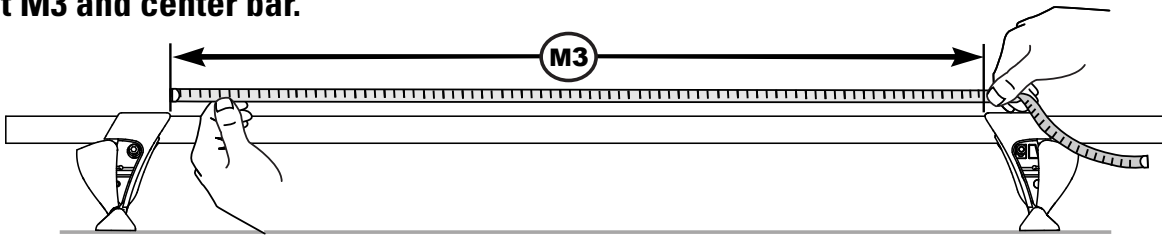

Note: Set measurements on a flat surface away from vehicle.



Pull the measuring tape tight to ensure accurate measurements. Measurements must be accurate to within 1/8" (3.2 mm).

TIP: To center crossbar between towers after setting your measurement use this technique. While pushing downward and rotating the crossbar, adjust the crossbar as needed to the left or right. Double check your M3 measurement and adjust if necessary.

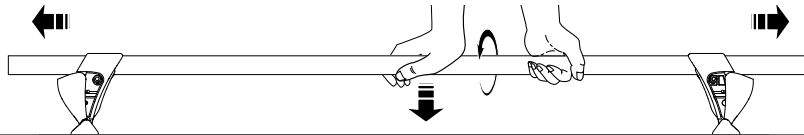

12 Tighten tower/bar assembly.



Be sure to not move the towers.

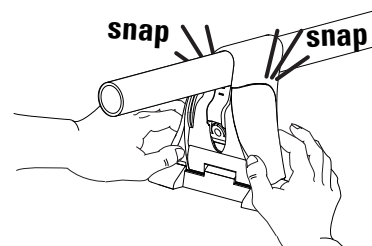
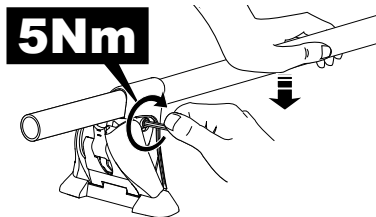

Snap the covers shut.

13 Label the towers.

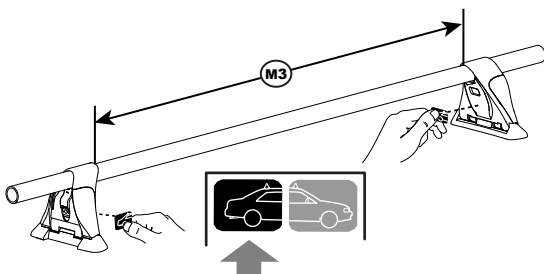

Label towers with rear of vehicle stickers.

14 Install end caps and correct pads.

Attach correct pads. Some vehicles require different pads on front (M1) and rear (M3). Pad letter is located in the center of each pad.



Keep the pads clean and free of debris. Clean pads as necessary, and keep them clean by not setting them on a dirty surface.

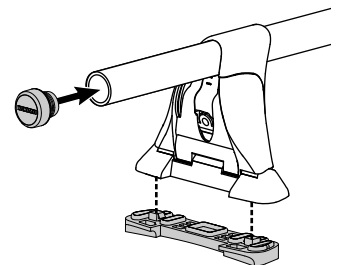

Overview

Prepare for installation

Install towers in front

Install towers in rear

Perform safety checks



YOU ARE HERE

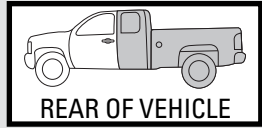

15 Position Towers in rear.

- Clean vehicle roof where towers will set.
- Set the assembly on the roof.

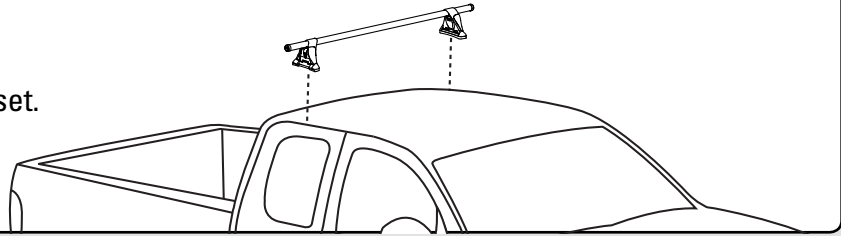

16 Set measurement.

- Use the combination of M2 and M4 measurements (from Clip Sheet).
- Measure the shortest distance from leading edge of tower base to nearest painted roofline corner.
- Once positioned DO NOT MOVE.

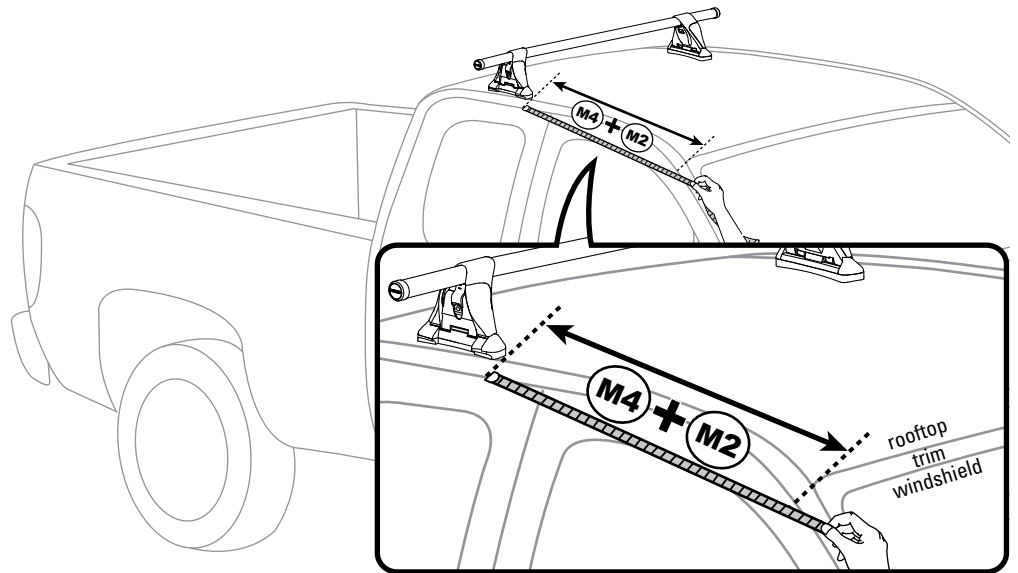

FOR EXAMPLE:

TOYOTA	M1	M2	M3	M4	M2 = 6"
Tundra Access Cab	99-02	Q107-A	Q107-A		+ +
	42 1/2"	6"	41 1/2"	32"	M4 = 32"
Tundra Tower Location					= 38"

Correct measurements can be found in the Q-Clip box.

If your vehicle is not listed or the clip sheet is not in the Q-Clip box check yakima.com/measurements, contact your dealer or call 888-925-4621.

17 Center rack on vehicle.

Center racks side to side by measuring from the door frame to tower base. Measuring points and distances on both sides must be equal.

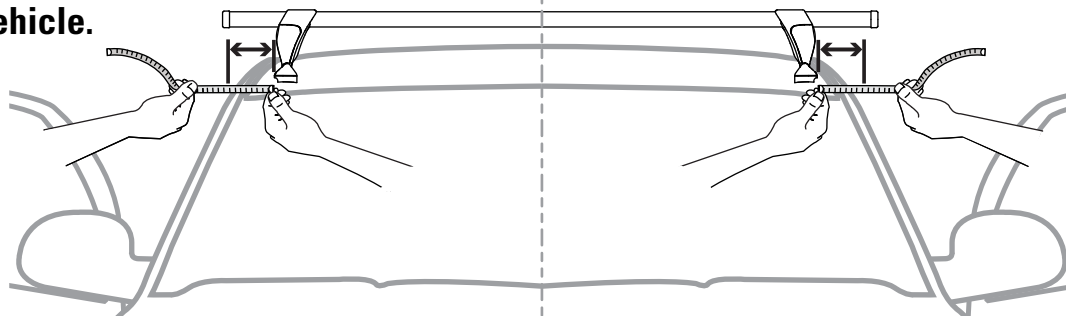

18 Apply vinyl pads to clips.

- Apply black vinyl pads wherever clip touches vehicle paint. Be sure to cover clip edges. Trim if necessary.

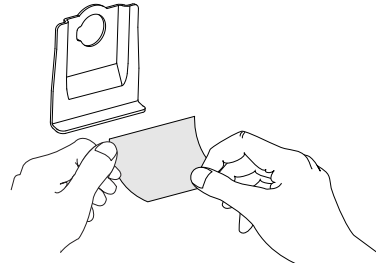

19 Assemble Q-Clips and lock housings.

- Insert the correct clip through the slits in clip holder.
- Insert lock housing through holes in clip and clip holder.

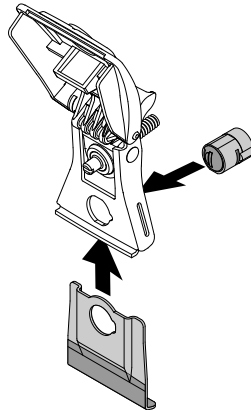

- Place clip fastener over lock housing to secure assembly.

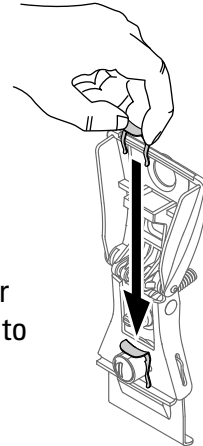

20 Loosely attach cam covers.



DO NOT MOVE TOWERS! If you bump the towers you'll need to go back and reposition them.

- Open both driver's side and passenger side doors.
- Carefully thread adjustment post on to tower to get the cover loosely attached (2 turns max).
- Repeat for other side.

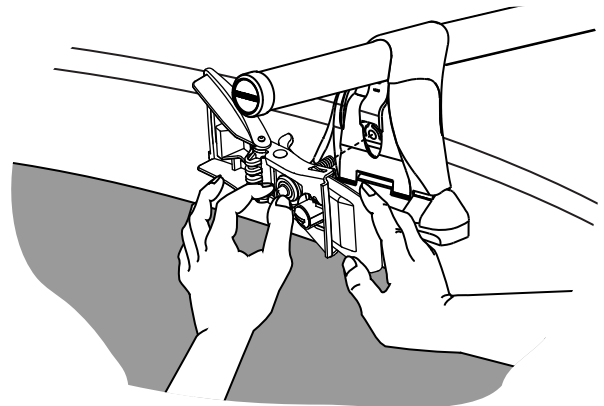

- Carefully push the clip in place up against the door frame. **DO NOT MOVE THE TOWERS.**
- Using the adjustment post, take slack out of the system until the cam cover closes **easily** while holding the clip to the door frame. **DO NOT FULLY TIGHTEN.**
- Repeat for other side.

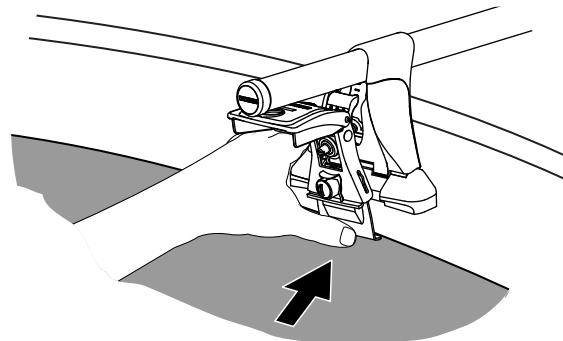

Check your M2 (front) or M2 + M4 (rear) again. Correct if needed (step 10 for front installation)(step 16 for rear installation).

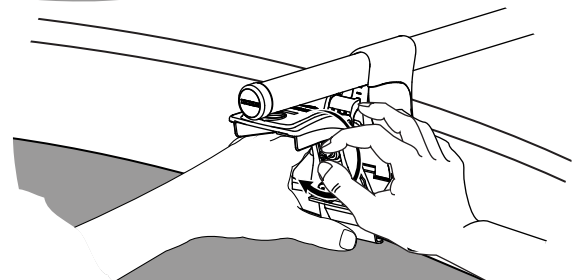

Install System

21a **The objective:** Your installation will be complete once you achieve balanced tower tension.

BALANCED TOWER TENSION REQUIREMENTS

1. Cam Cover closes with firm and equal resistance on both sides of the vehicle.
2. Gold Slider positions are equal on both sides of the vehicle. Reference hash marks on tower body.
3. **For Bladed Clips Only:** Gold Slider position must also be ON OR BETWEEN HASH MARKS.

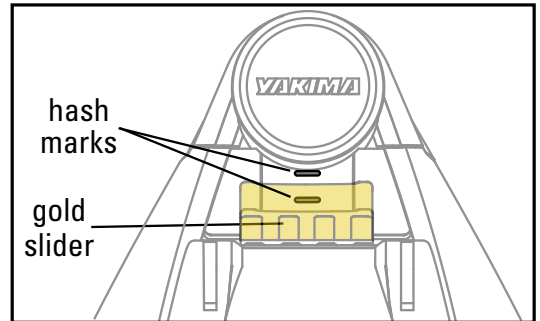

bladed clips
(see page 2)

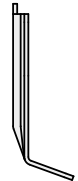

21b **The technique:** Slowly tighten your towers by turning the adjustment posts clockwise one full turn at a time, alternating from driver's side tower to passenger's side tower. **Close the Cam Cover after each adjustment.** Only one Cam Cover can be open at a time.

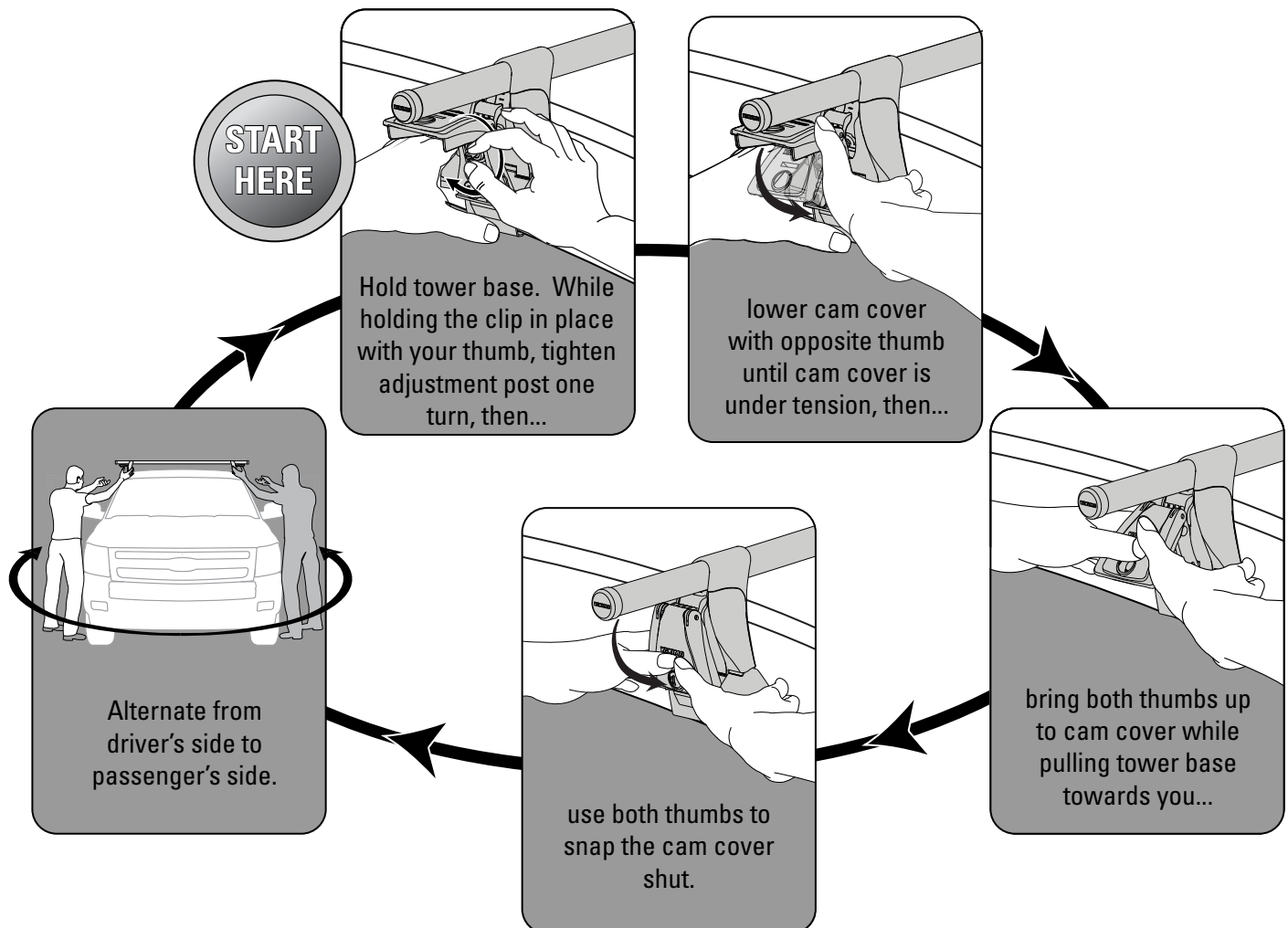

Perform this technique on both the driver side and passenger side in an alternating fashion until you achieve balanced tower tension.

Overview

Prepare for installation

Install towers in front

Install towers in rear

Perform safety checks



22 Perform Safety Checks With Vehicle Doors Open.

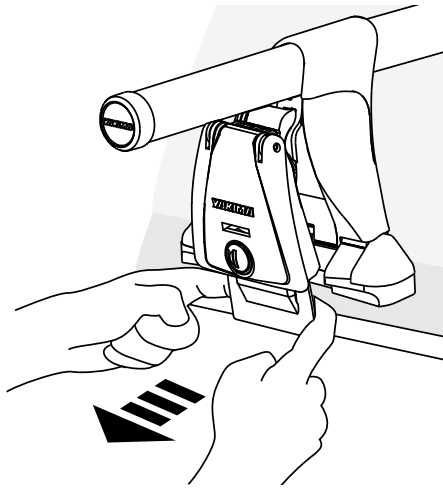

CHECK EACH CLIP! Pull each clip away from vehicle. **PULL HARD!**

Repeat twice. **Clip should not move on second pull.**

CHECK EACH TOWER! Grip the bar inboard to towers; push and pull using only arm strength.

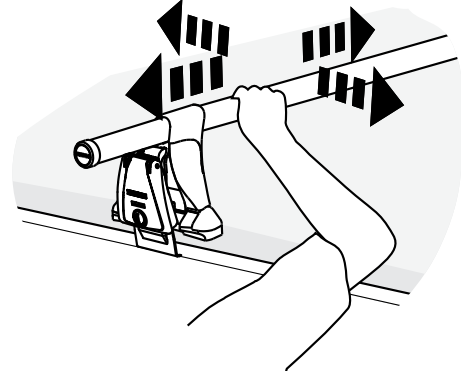

If any of the clips or Towers move, check gold slider positions, and fine tune by tightening adjustment posts gradually (step 21b). If there is still movement after fine tuning, verify the M1 (front installation) or M3 (rear installation).

Once installed, easy on easy off without tools.

REMOVING THE SYSTEM

Unlock towers and open cam covers.
Lift rack up and off (do not disassemble).

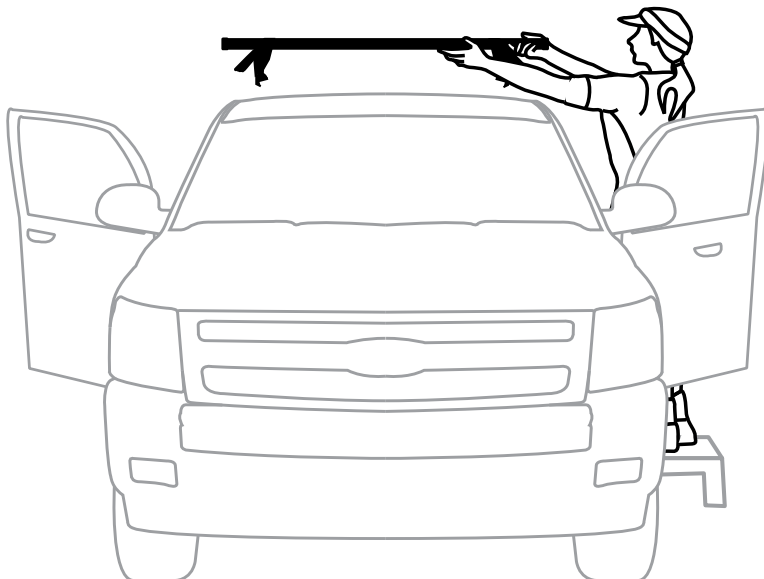

INSTALLING RACKS AGAIN

- Open cam covers.
- Clean roof and place towers at M2 (for front installation) or M4 + M2 position (for rear installation); measure carefully.

• Make sure clips are seated properly, then close cam covers with firm resistance.

PERFORM SAFETY CHECKS ON ALL TOWERS AND CLIPS AFTER EVERY INSTALLATION! (Step 22)



Failure to check clips and towers before driving away can result in property damage, personal injury, or death.

23 LOCK THE TOWERS.

If you have purchased lock cores, install them according to lock instructions.

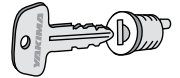

24 Tie down LONG LOADS

Any load extending over the windshield (except luggage boxes) must be secured to both the front and rear of the vehicle, in addition to the rack. Failure to do so can result in property damage, personal injury or death.

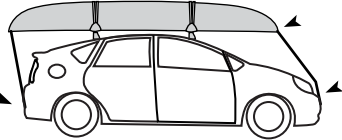

IMPORTANT!

Be sure to read all the warnings and warranty information contained in the insert accompanying these instructions!



WEIGHT LIMITS

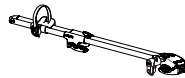

Not more than 165 lbs. (75 kg) unless otherwise noted.

CHECK THE CLIP SHEET NOTES, YAKIMA FITLIST, OR AT YAKIMA.COM FOR YOUR ROOF'S WEIGHT LIMIT.

REAR HATCH

Some longer loads may prevent the rear hatch from fully opening.

USE CAUTION WHEN OPENING YOUR HATCH.

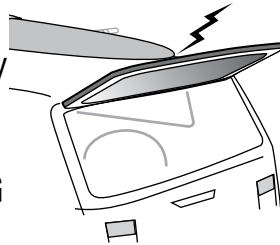

REMOVE ACCESSORY BEFORE ENTERING AN AUTOMATIC CAR WASH.

SUN ROOF

USE CAUTION WHEN OPENING SUNROOF.

Sunroof may interfere with crossbars or accessories.

FACTORY LUGGAGE CARRIER

If the vehicle is equipped with a factory luggage carrier, it may interfere with some accessories.

ANTENNA

Antenna on the roof may need to be removed to prevent interference with the rack or long loads.



WARNING: Be sure all hardware is secured according to instructions. Attachment hardware can loosen over time. Check before each use, and tighten if necessary.

KEEP THESE INSTRUCTIONS!

YAKIMA

Q TOWERS

PIEDS Q À LA PAIRE

FR



BOUCHON (x 4)



AUTOCOLLANT (x 1)



CLIP EN U (x 4)

LOGEMENT DE SERRURE (x 4)

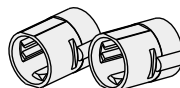

RUBAN À MESURER (x 1)

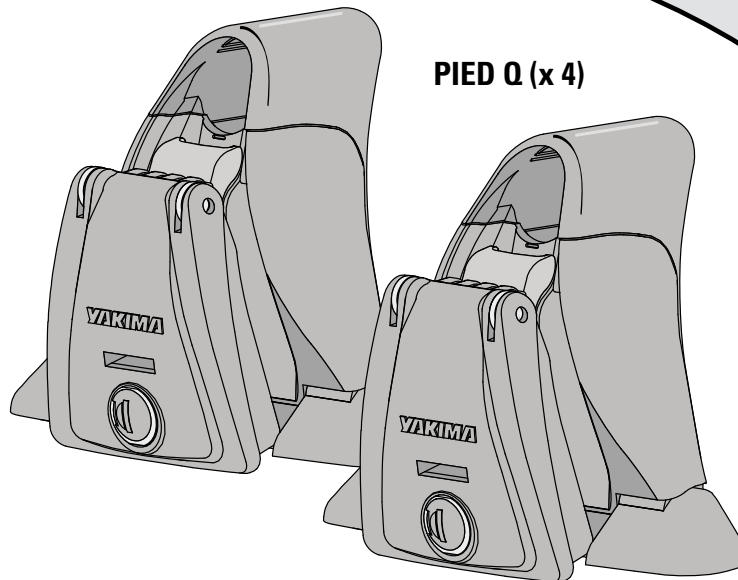
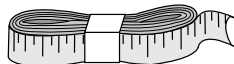

PIED Q (x 4)

Les crochets Q, qui sont spécifiques au véhicule, et les barres transversales s'achètent à part et à la paire.

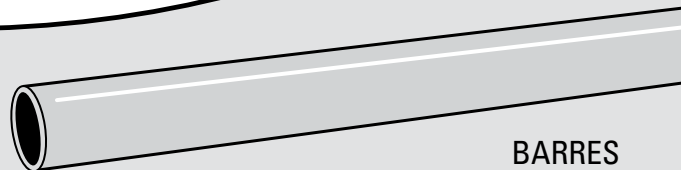

BARRES TRANSVERSALES



GARNITURES EN VINYLE

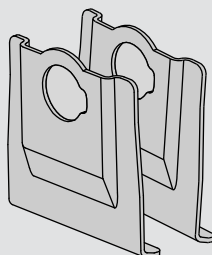

CROCHETS Q

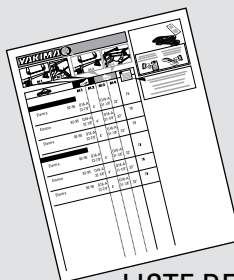

LISTE DE MESURES

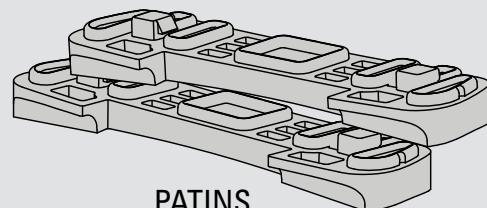

PATINS



AVERTISSEMENT IMPORTANT

IL EST ESSENTIEL QUE TOUS LES SUPPORTS ET ACCESSOIRES YAKIMA SOIENT FIXÉS ET ATTACHÉS SOLIDEMENT À VOTRE VÉHICULE. UNE ATTACHE INADÉQUATE PEUT CAUSER UN ACCIDENT DU VÉHICULE ET DES BLESSURES GRAVES OU MORTELLES POUR VOUS OU POUR LES AUTRES. IL VOUS INCOMBE DE FIXER LES SUPPORTS ET ACCESSOIRES À VOTRE VÉHICULE, DE VÉRIFIER LES ATTACHES AVANT D'UTILISER LE DISPOSITIF, DE VÉRIFIER RÉGULIÈREMENT QUE LE PRODUIT EST AJUSTÉ, ET QU'IL N'EST PAS USÉ OU ENDOMMAGÉ. IL VOUS FAUT DONC LIRE ET COMPRENDRE TOUTES LES DIRECTIVES ET MISES EN GARDE FOURNIES AVEC VOTRE PRODUIT YAKIMA AVANT DE L'INSTALLER OU DE L'UTILISER. SI TOUTES LES INSTRUCTIONS ET MISES EN GARDE NE SONT PAS COMPRIS, OU SI L'ON N'A AUCUNE EXPÉRIENCE EN MÉCANIQUE ET QUE L'ON N'EST PAS TRÈS FAMILIER AVEC LES PROCÉDURES D'INSTALLATION, FAIRE INSTALLER LE PRODUIT PAR UN INSTALLATEUR PROFESSIONNEL COMME UN GARAGISTE QUALIFIÉ OU RÉPARATEUR DE VÉHICLEROSSERIE.

Présentation

Préparation

Pose des
pieds en avant

Pose des
pieds en arrière

Vérifications
de sécurité



Description du pied Q.

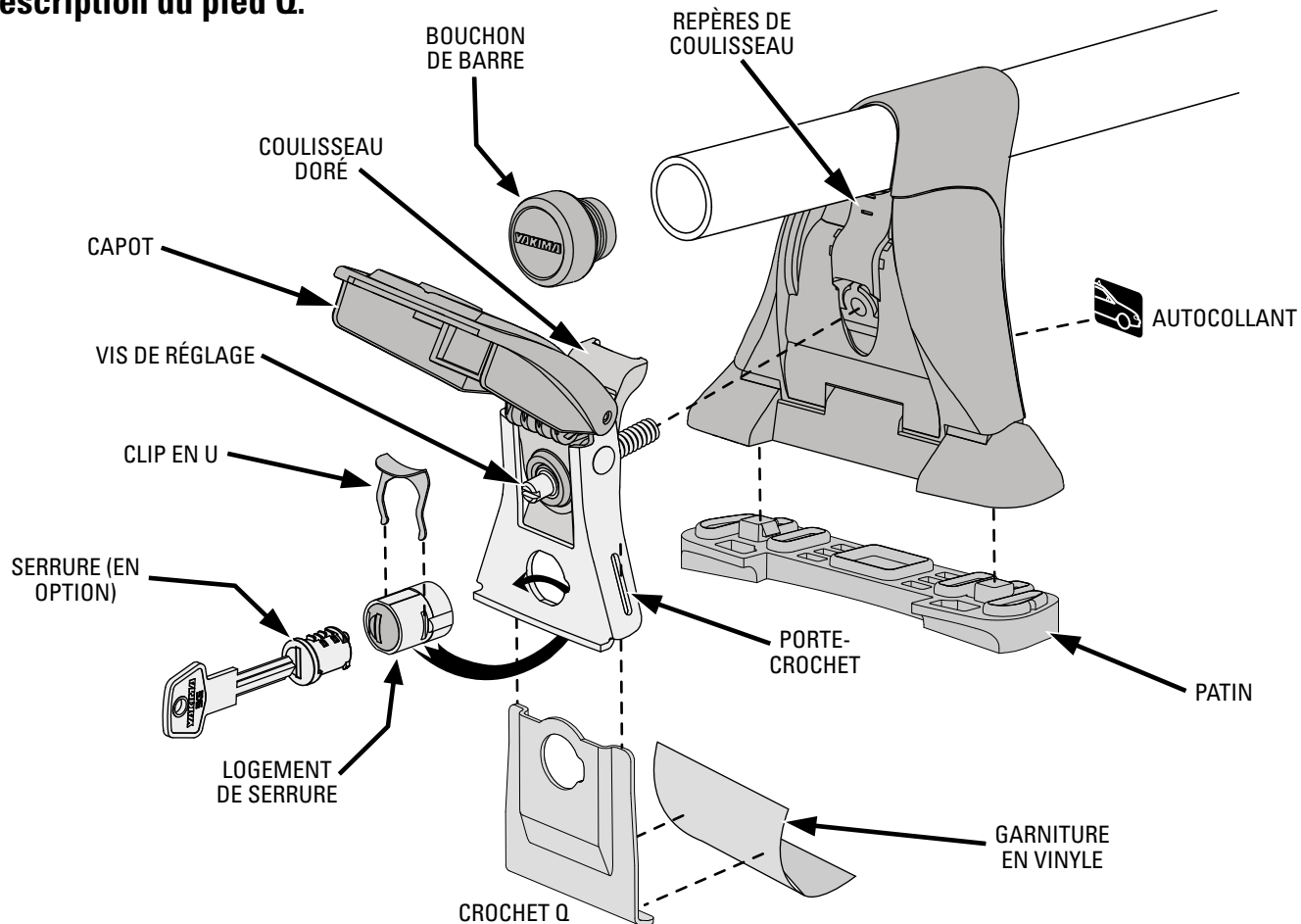

Les familles de crochets Q.

Le crochets Q existent en diverses formes et diverses tailles, mais ils appartiennent tous à cinq grands types. Il faut un pied Q spécifique à chaque véhicule pour installer les pieds Q. C'est pourquoi les crochets Q sont vendus à part. On illustre ci-dessous des exemples des cinq types de crochets Q.

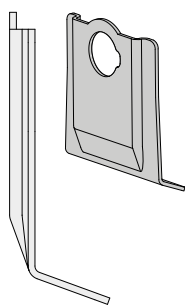

PLAT

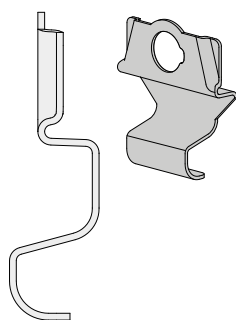

AVION

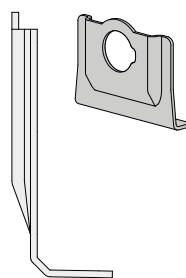

GOUTTIÈRE

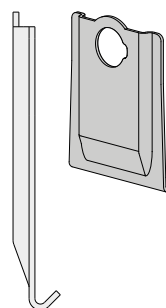

CROCHET

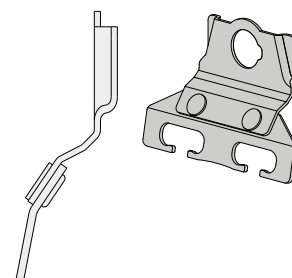

EXCLUSIF
(SE FIXE À UN DISPOSITIF MONTÉ
D'ORIGINE SUR LE VÉHICULE)

Présentation

Préparation

Pose des
pieds en avant

Pose des
pieds en arrière

Vérifications
de sécurité



1 Enlever les capots.

Dévisser la vis de réglage pour enlever le capot de chacun des quatre pieds.

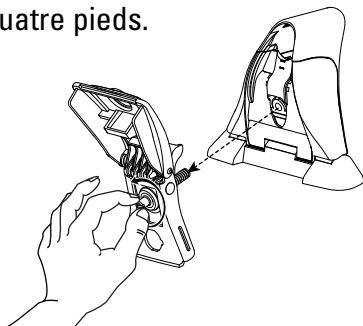

2 Ouvrir les pieds.

Ouvrir chaque pied pour avoir accès à la vis de blocage de la barre.

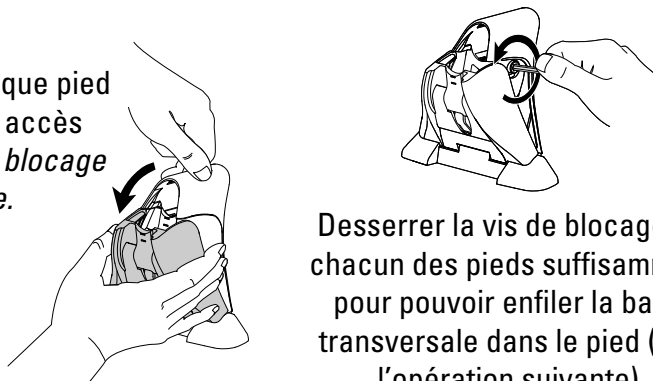

Desserrer la vis de blocage de chacun des pieds suffisamment pour pouvoir enfiler la barre transversale dans le pied (voir l'opération suivante).

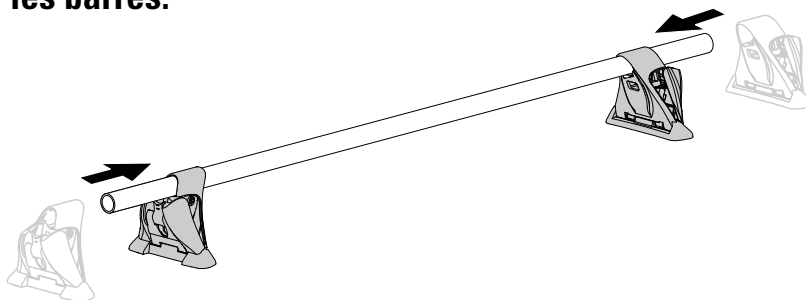

3 Enfiler les pieds sur les barres.

Enfiler deux pieds sur chaque barre transversale.



4 Trouver les 4 "M" (mesures) s'appliquant au véhicule.

Repérer dans la liste de mesures celles qui s'appliquent précisément au véhicule.

			
MARQUE	M1	M2	M3
	M4		

Noter les quatre mesures aux endroits prévus à droite. Conserver ces instructions en lieu sûr pour pouvoir les consulter plus tard.

Si la liste de mesures ne se trouve pas dans la boîte des crochets Q, ou si le véhicule n'y figure pas, consultez le site yakima.com/roof-rack-installation, contactez votre dépositaire ou appelez au 888-925-4621.



MA VOITURE :

M1= _____

M2= _____

M3= _____

M4= _____



Va-t-on poser les pieds Q à l'AVANT ou à l'ARRIÈRE ?
Si la pose se fait à l'AVANT, poursuivre ci-dessous. Pour la pose à l'ARRIÈRE, sauter à l'opération 11.

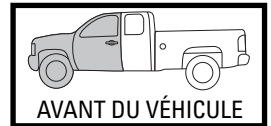

5 Appliquer la mesure M1 et centrer la barre.

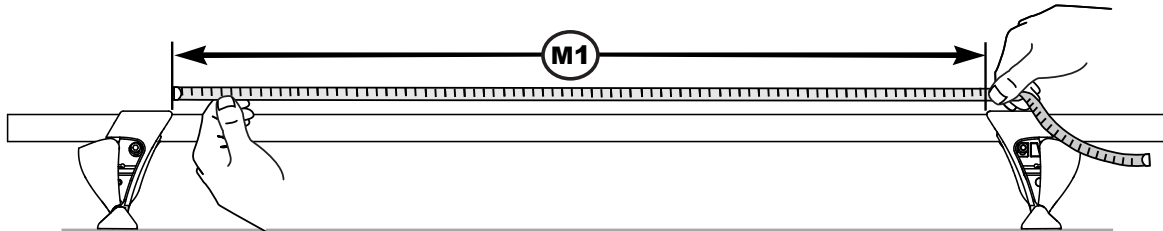

Remarque : appliquer les mesures sur une surface plate, et non pas sur le véhicule.



Bien tendre le ruban à mesurer pour que les mesures soient précises. Les mesures doivent être exactes à 3,2 mm (1/8 po) près.

CONSEIL : pour centrer la barre transversale entre les pieds après avoir réglé la mesure, procéder ainsi. Tout en poussant la barre vers le bas, la faire tourner sur elle-même pour la faire glisser vers la gauche ou la droite. Vérifier de nouveau la mesure M1 et la corriger au besoin.

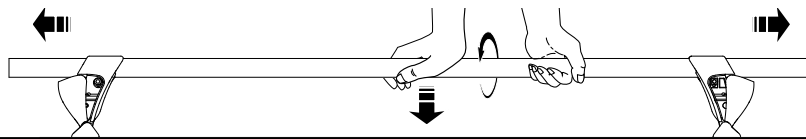

6 Serrer les pieds sur les barres.



Veiller à ne pas bouger les pieds.

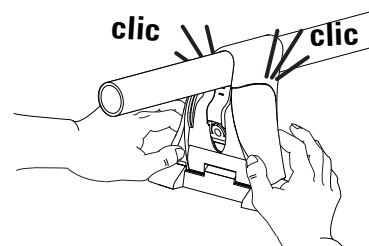
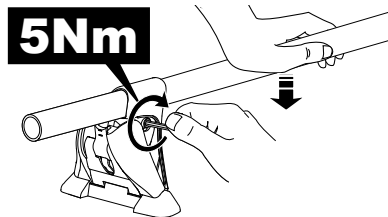

Rabattre les capots.

7 Étiqueter les pieds.

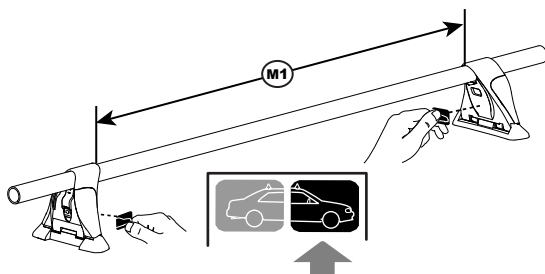

Appliquer les autocollants "pieds avant".

8 Poser les bouchons et les bons patins.

Mettre en place les bons patins. Pour certaines voitures, les patins sont différents à l'avant (M1) et à l'arrière (M3). Les patins portent au centre une lettre d'identification.



Garder les patins propres. Les nettoyer au besoin et les garder propres en ne les déposant pas sur une surface sale.

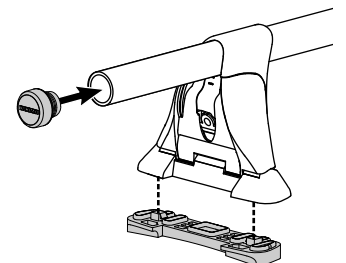

Présentation

Préparation

Pose des
pieds en avant

Pose des
pieds en arrière

Vérifications
de sécurité

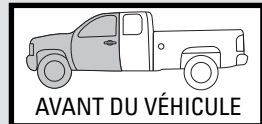

9 Positionner les pieds en avant.

- Nettoyer le toit du véhicule là où les pieds porteront.
- Déposer la barre et les pieds sur le toit.

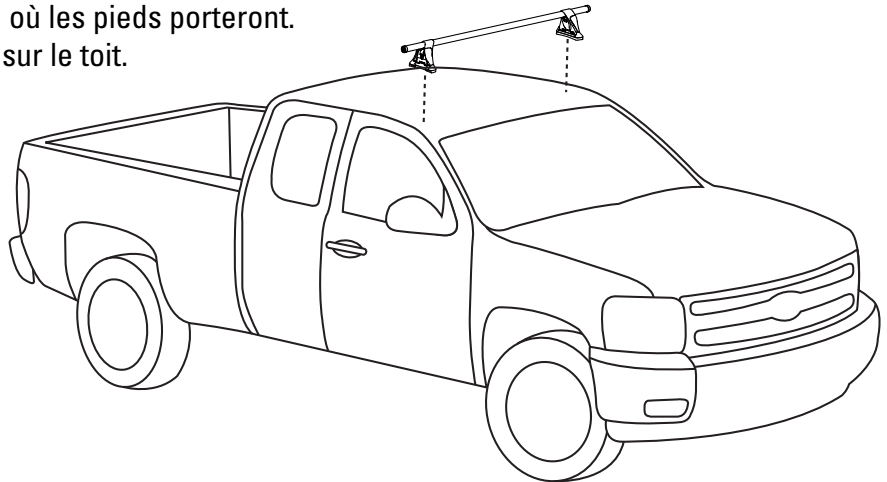

10 Reporter la mesure M2.

- EMPLOYER LA MESURE M2 trouvée à l'opération 4.
- Mesurer la distance la plus courte entre l'avant de la base du pied et le coin peint du toit le plus proche.
- Une fois les pieds positionnés, NE PLUS LES DÉPLACER.

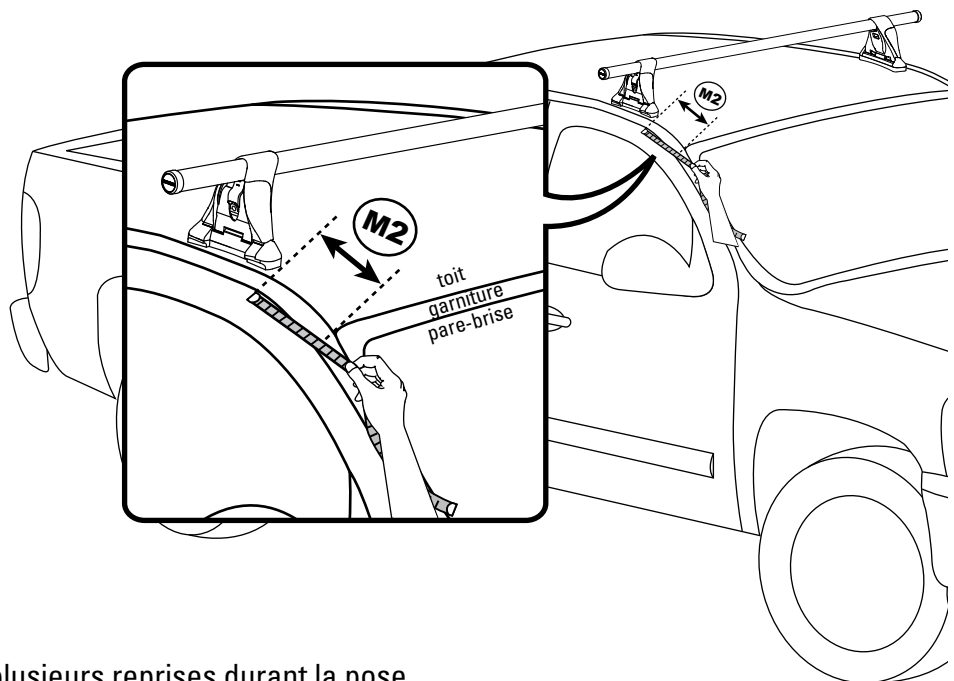

CONSEIL : vérifier cette mesure à plusieurs reprises durant la pose.

Pour continuer la pose des pieds avant, sauter à l'opération 17.



Va-t-on poser les pieds Q à l'AVANT ou à l'ARRIÈRE ?
Si la pose se fait à l'ARRIÈRE, poursuivre ci-dessous. Pour
la pose à l'AVANT, sauter à l'opération 5.

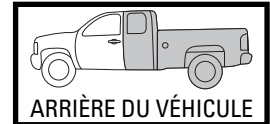

11 Appliquer la mesure M3 et centrer la barre.

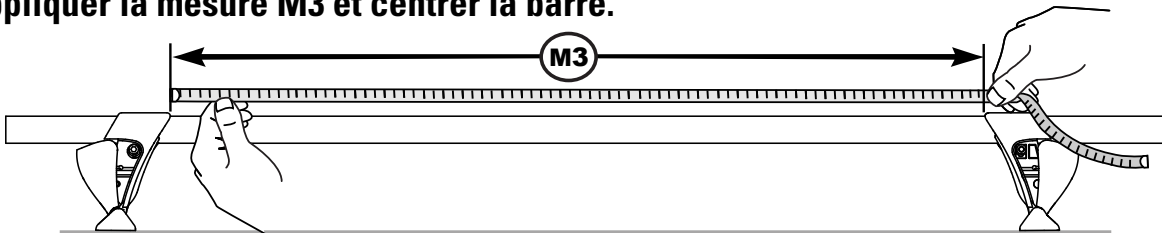

Remarque : appliquer les mesures sur une surface plate, et non pas sur le véhicule.



Bien tendre le ruban à mesurer pour que les mesures soient
précises. Les mesures doivent être exactes à 3,2 mm (1/8 po) près.

CONSEIL : pour centrer la barre transversale entre les pieds après avoir réglé la mesure,
procéder ainsi. Tout en poussant la barre vers le bas, la faire tourner sur elle-même pour la faire
glisser vers la gauche ou la droite. Vérifier de nouveau la mesure M3 et la corriger au besoin.

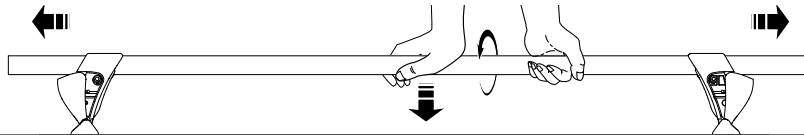

12 Serrer les pieds sur les barres.



Veiller à ne pas
bouger les pieds.

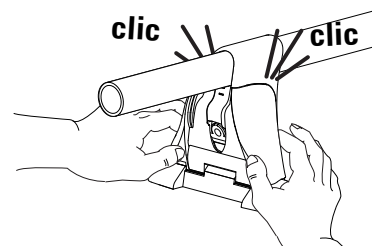
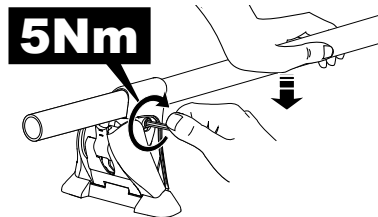

Rabattre les
capots.

13 Étiqueter les pieds.

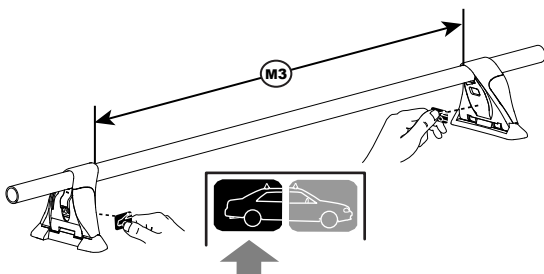

Appliquer les autocollants "pieds arrière".

14 Poser les bouchons et les bons patins.

Mettre en place les bons patins. Pour certaines
voitures, les patins sont différents à l'avant (M1)
et à l'arrière (M3). Les patins portent au centre
une lettre d'identification.



Garder les patins propres.
Les nettoyer au besoin et
les garder propres en ne
les déposant pas sur une
surface sale.

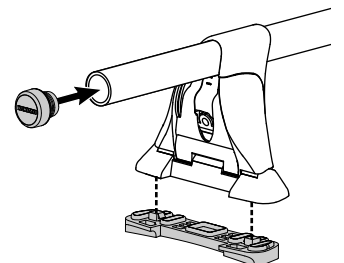

Présentation

Préparation

Pose des
pieds en avant

Pose des
pieds en arrière

Vérifications
de sécurité

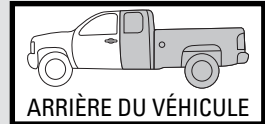

15 Positionner les pieds en arrière.

- Nettoyer le toit du véhicule là où les pieds porteront.
- Déposer la barre et les pieds sur le toit.

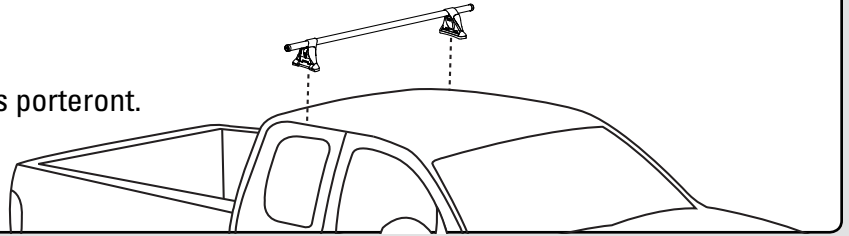

16 Appliquer les mesures.

- Ajouter ensemble les mesures M2 et M4 (du feuillet qui accompagne les crochets).
- Mesurer la distance la plus courte entre l'avant de la base du pied et le coin peint du toit le plus proche.
- Une fois les pieds positionnés, NE PLUS LES DÉPLACER.

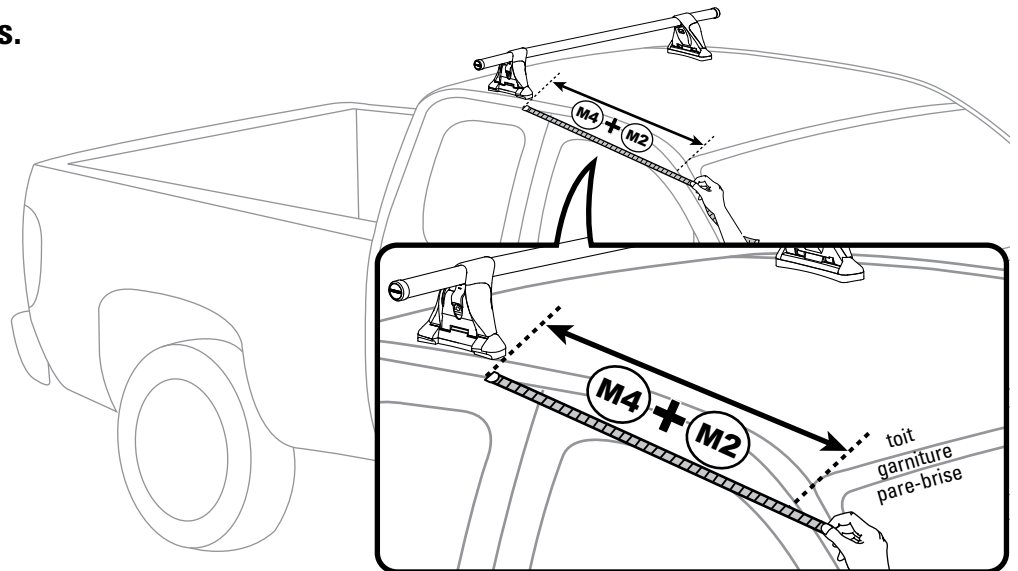

PAR EXEMPLE :

TOYOTA	M1	M2	M3	M4	M2 = 6"
Tundra Access Cab	99-02	Q107-A 42 1/2"	6"	Q107-A 41 1/8"	32"
					M4 = 32"

Position des pieds pour un Tundra = 38 po

Les mesures à employer se trouvent sur le feuillet qui accompagne les crochets Q.

Si la liste de mesures ne se trouve pas dans la boîte des crochets Q, ou si le véhicule n'y figure pas, consulter le site Yakima.com/measurements, contacter le dépositaire ou appeler au 888-925-4621.

17 Centrer la barre avant sur le véhicule.

Centrer le porte-bagage latéralement en mesurant depuis le cadre des portières jusqu'à la base des pieds. Les points de repère et les distances doivent être les mêmes des deux côtés.

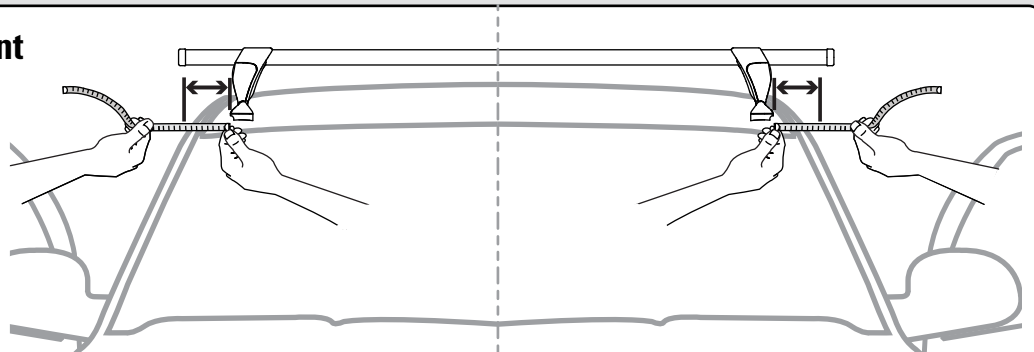

18 Coller les garnitures en vinyle sur les crochets avant sur les crochets avant.

- Coller les garnitures en vinyle noir sur les crochets, aux endroits où ils touchent la peinture. S'assurer de recouvrir les rebords des crochets. Couper l'excédent si nécessaire.

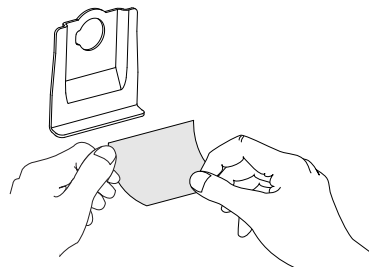

19 Assembler les crochets Q et les logements de serrure.

- Insérer le bon crochet dans les fentes du porte-crochet.
- Enfiler le logement de serrure à travers le crochet et le porte-crochet.

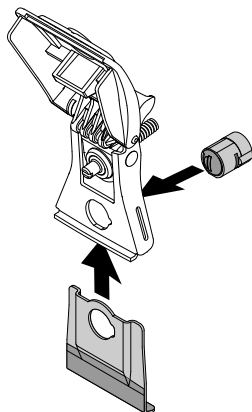

- Enfiler le clip en U sur le logement de serrure pour retenir les pièces ensemble.

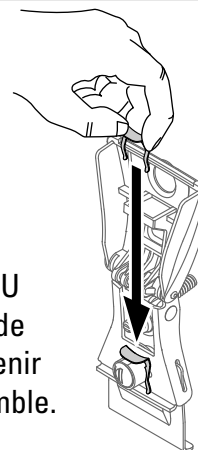

20 Assembler les crochets Q et les logements de serrure.



NE PAS DÉPLACER LES PIEDS ! Si on les déplace accidentellement, il faut les positionner de nouveau.

- Ouvrir les deux portières avant du véhicule.
- Engager délicatement la vis de réglage dans le pied pour juste retenir le capot (2 tours maximum).
- Procéder de même de l'autre côté.

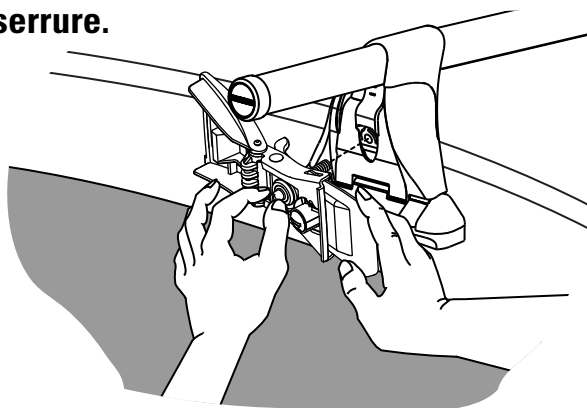

- Appuyer délicatement le crochet contre le cadre de la portière. **NE PAS DÉPLACER LES PIEDS.**
- Tout en retenant le crochet contre le cadre de la portière, faire disparaître le jeu en serrant la vis de réglage, jusqu'à ce que la capot se ferme **facilement**. **NE PAS SERRER COMPLÈTEMENT.**
- Procéder de même de l'autre côté.

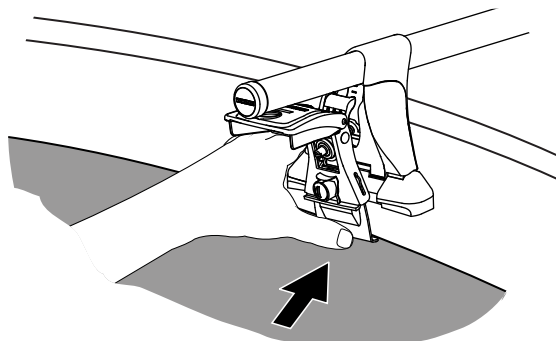

Vérifier de nouveau la mesure M2 (pour l'avant) ou les mesures M2 + M4 (pour l'arrière). Corriger au besoin (opération 10 pour montage à l'avant, opération 18 pour montage à l'arrière).

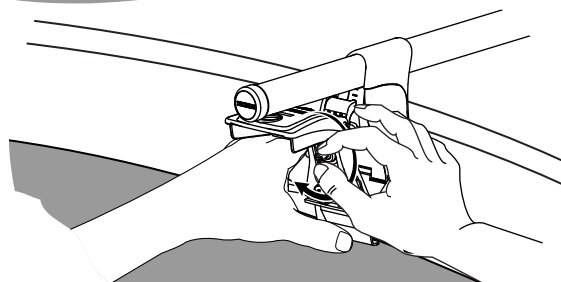

Mise en place

21a L'objectif : la pose sera réussie une fois que l'on aura obtenu une tension équilibrée sur les pieds.

LA TENSION EST ÉQUILIBRÉE SUR LES PIEDS SI :

1. Les capots se rabattent avec une résistance ferme et égale des deux côtés du véhicule.
2. Les coulisseaux dorés sont au même niveau des deux côtés. Se servir des repères sur les pieds.
3. **Pour les crochets plats seulement :** la position des coulisseaux dorés doit en plus tomber **SUR OU ENTRE LES REPÈRES**.

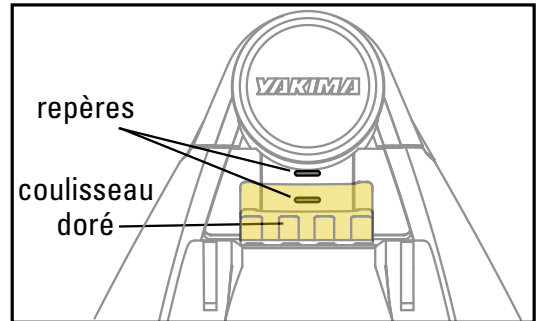

crochets plats
(voir la page 2)

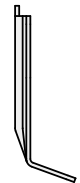

21b La technique : serrer progressivement les pieds en tournant la vis de réglage d'un tour complet vers la droite, en alternant entre le pied côté conducteur et le pied côté passager. **Rabattre le capot après chaque réglage.** Seul un capot ne doit être relevé à la fois.

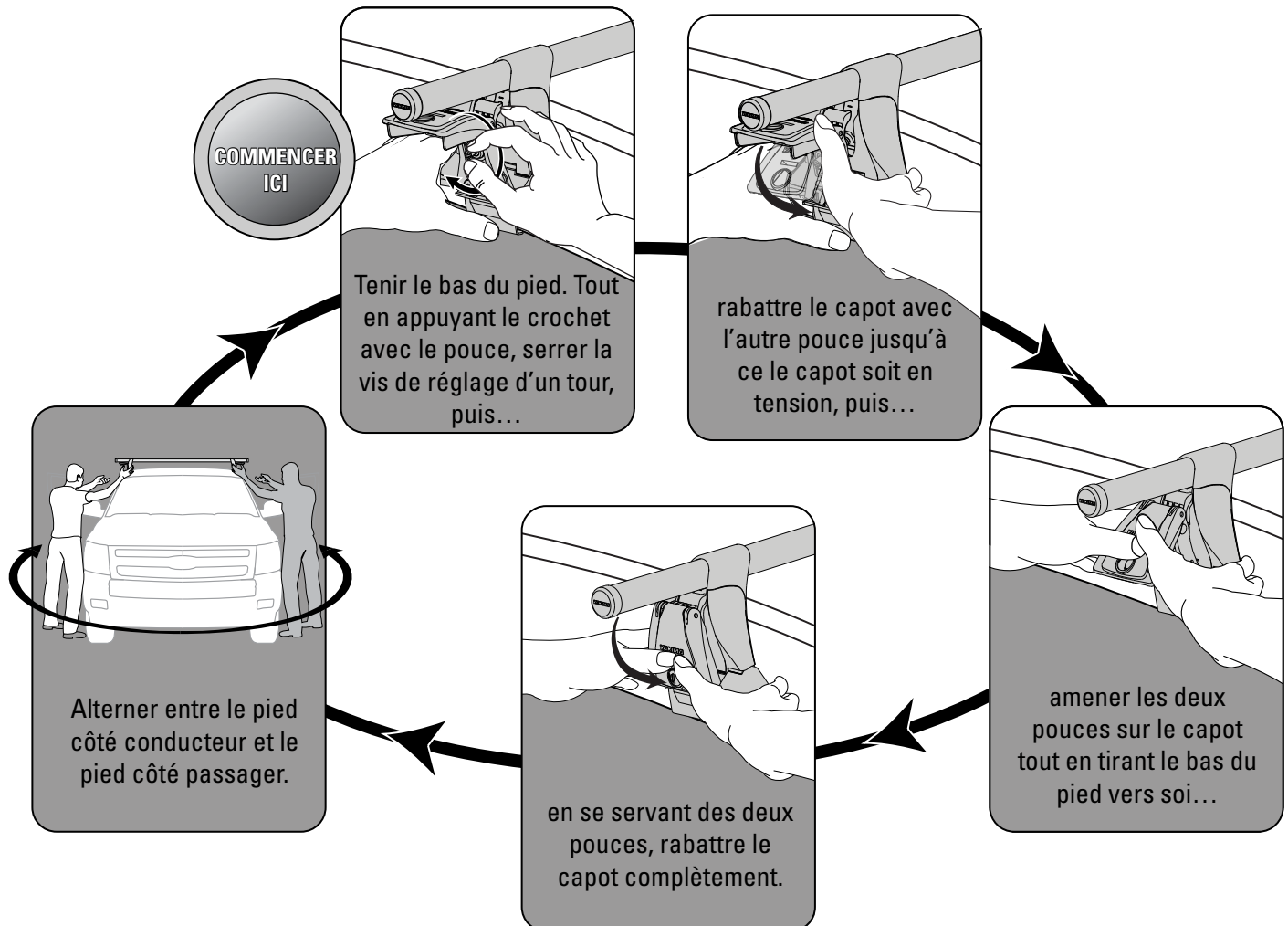

Répéter cette technique en alternant entre le côté conducteur et le côté passager jusqu'à obtenir une tension équilibrée sur les deux pieds.

Présentation

Préparation

Pose des
pieds en avant

Pose des
pieds en arrière

Vérifications
de sécurité

Vous
êtes ici

22 Avec les portières ouvertes, effectuer les vérifications de sécurité.

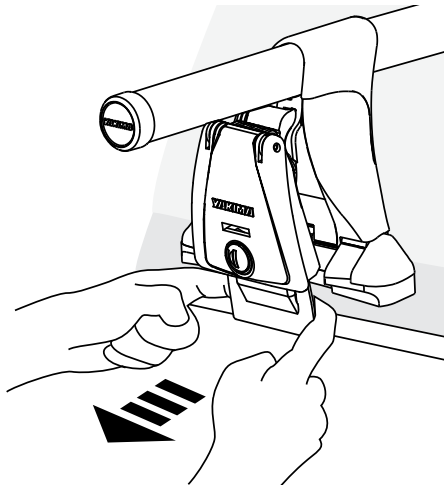

VÉRIFIER CHAQUE CROCHET !

Chercher à éloigner chaque crochet de la voiture. **TIRER FORT !**

Recommencer. **Le crochet ne doit pas bouger à la deuxième reprise.**

VÉRIFIER CHAQUE PIED !

Prendre la barre à l'intérieur du pied ; pousser et tirer en forçant avec le bras seulement.

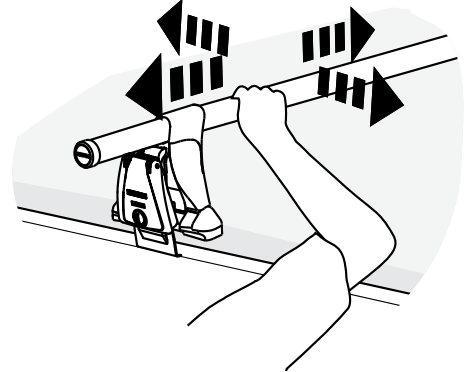

Si un crochet ou un pied bouge, vérifier la position des coulisseaux dorés et corriger la tension en serrant les vis de réglage graduellement (opération 21b). S'il y a encore du mouvement après ces réglages, vérifier la mesure M1 (montage à l'avant) ou la mesure M3 (montage à l'arrière).

Une fois le porte-bagage installé, il s'enlève et se remet facilement et sans outils.

POUR ENLEVER LE PORTE-BAGAGES

Déverrouiller les pieds et relever les capots. Enlever le porte-bagages en le soulevant (ne pas le démonter).

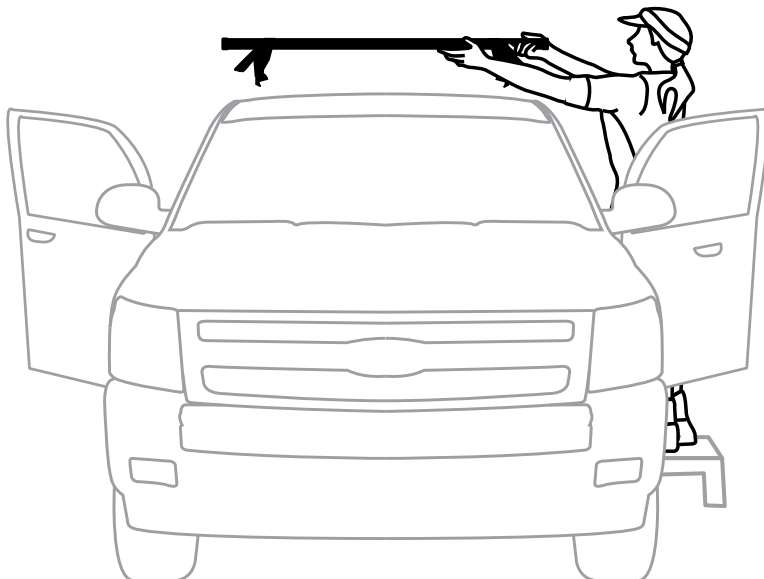

POUR REMETTRE LE PORTE-BAGAGES EN PLACE

- Relever les capots.
 - Nettoyer le toit et placer les pieds à leurs positions M2 (montage à l'avant) ou M2 + M4 (montage à l'arrière) ; mesurer avec soin.
 - Positionner les crochets avec soin puis rabattre les capots, qui doivent se fermer avec une résistance ferme.
- EFFECTUER LES VÉRIFICATIONS DE SÉCURITÉ SUR CHAQUE PIED ET SUR CHAQUE CROCHET APRÈS CHAQUE REMONTAGE ! (OPÉRATION 22).**



Si l'on ne vérifie pas les crochets et les pieds avant de prendre la route, on risque de provoquer des dommages, des blessures ou même la mort.

23

VERROUILLER LES PIEDS.

Si l'on a acheté des serrures, les installer en suivant les instructions qui les accompagnent.

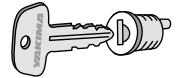

24

ARRIMER LES CHARGES LONGUES.

Une charge qui dépasse au-dessus du pare-brise (sauf une caisse de transport) doit obligatoirement être arrimée à l'avant et à l'arrière du véhicule, en plus du porte-bagage, sous peine de risquer de provoquer des dommages, des blessures ou même la mort.

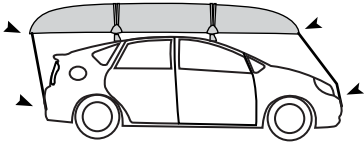

IMPORTANT!

S'assurer de lire les avertissements et les renseignements sur la garantie figurant sur le feuillet qui accompagne ces instructions !



LIMITES DE CHARGEMENT

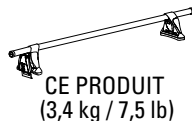
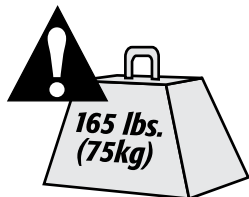

Pas plus de 75 kg (165 lb) à moins d'indication contrairec.

CONSULTER LA LISTE DE MESURES, LA LISTE DE COMPATIBILITÉ ("FIT LIST") YAKIMA OU LE SITE YAKIMA.COM POUR CONNAÎTRE LA CHARGE MAXIMALE QUE PEUT SUPPORTER LE TOIT DU VÉHICULE.

HAYON

Certaines charges longues pourraient empêcher d'ouvrir le hayon complètement.

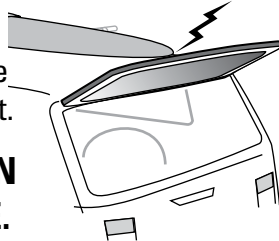

OUVRIR LE HAYON AVEC PRUDENCE.



ENLEVER L'ACCESSOIRE AVANT DE PASSER DANS UN LAVE-AUTO AUTOMATIQUE.

TOIT OUVRANT

OUVRIR LE TOIT OUVRANT AVEC PRUDENCE.

L'ouverture du toit ouvrant pourrait être gênée par la présence des barres transversales ou d'accessoires.

PORTE-BAGAGE MONTÉ D'ORIGINE

Si le véhicule est muni d'un porte-bagage monté d'origine, il pourrait gêner l'utilisation de certains accessoires.

ANTENNA

Il faudra peut-être enlever l'antenne du toit si elle gêne le porte-bagage ou les longues charges.



AVERTISSEMENT : S'assurer que le montage est solide et conforme aux instructions. Les dispositifs de fixation peuvent se desserrer à la longue. Les inspecter avant chaque utilisation et les resserrer au besoin.

CONSERVER CES INSTRUCTIONS !

YAKIMA

QTOWERS

PARA EL PAR

ES

**CAPUCHÓN DE
EXTREMO (4X)**



ETIQUETAS (1X)



CLIP EN U (4X)

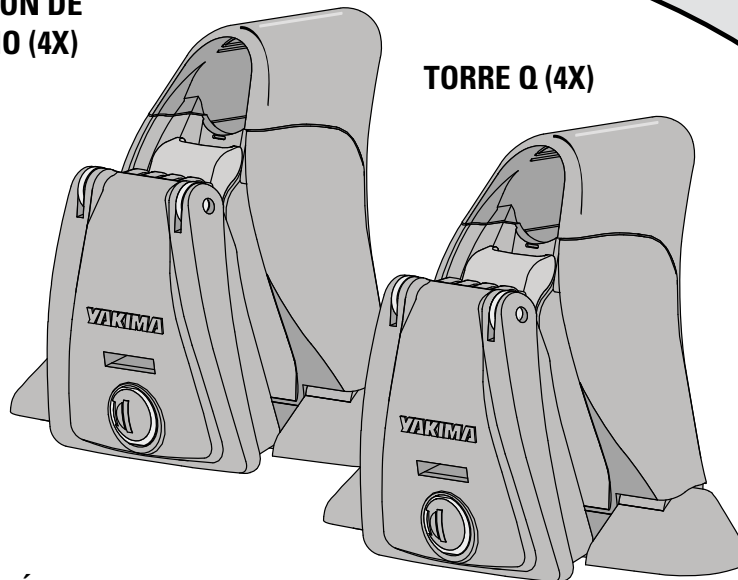

TORRE Q (4X)

**RECEPTÁCULO DE
CERRADURA (4X)**

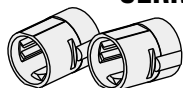

CINTA MÉTRICA (1X)

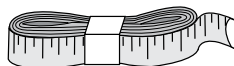

**Los clips Q y los travesaños
específicos para su vehículo se
venden en forma separada por pares.**

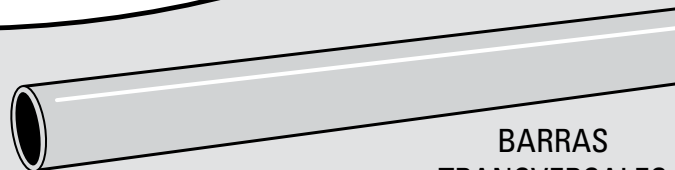

**BARRAS
TRANSVERSALES**



**PROTECTORES
DE VINILO**

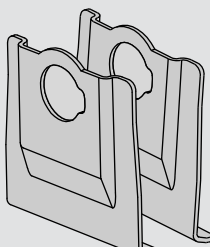

CLIPS Q

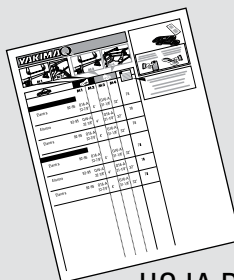

**HOJA DE
MEDIDAS DE CLIPS**

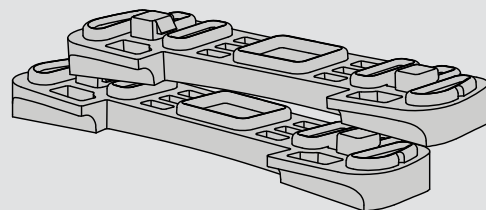

ALMOHADILLAS



ADVERTENCIA IMPORTANTE

ES FUNDAMENTAL QUE TODOS LOS PORTAEQUIPAJES Y ACCESORIOS YAKIMA ESTÉN FIJADOS DE MANERA CORRECTA Y SEGURA AL VEHÍCULO. UNA INSTALACIÓN DEFICIENTE PODRÍA CAUSAR UN ACCIDENTE AUTOMOVILÍSTICO Y PROVOCAR HERIDAS GRAVES O LA MUERTE A USTED O A TERCEROS. USTED ES RESPONSABLE DE LA FIJACIÓN SEGURA DE LOS PORTAEQUIPAJES Y ACCESORIOS AL VEHÍCULO. VERIFICANDO LAS UNIONES Y AMARRES ANTES DE UTILIZARLOS E INSPECCIONANDO PERIÓDICAMENTE EL AJUSTE DE LOS PRODUCTOS, SU DESGASTE Y POSIBLES DAÑOS. POR ELLO, DEBE LEER Y COMPRENDER TODAS LAS INSTRUCCIONES Y ADVERTENCIAS QUE VIENEN CON LOS PRODUCTOS YAKIMA ANTES DE INSTALARLOS O USARLOS. SI NO ENTIENDE TODAS LAS INSTRUCCIONES Y ADVERTENCIAS, O NO TIENE EXPERIENCIA EN MECÁNICA O NO ESTÁ FAMILIARIZADO CON LOS PROCEDIMIENTOS DE INSTALACIÓN, HAGA INSTALAR EL PRODUCTO POR UN INSTALADOR PROFESIONAL.

Vista del conjunto



Prepárese para la instalación

Instale las torres en la parte delantera

Instale las torres en la parte trasera

Verifique la seguridad de la instalación

Anatomía de la torre Q.

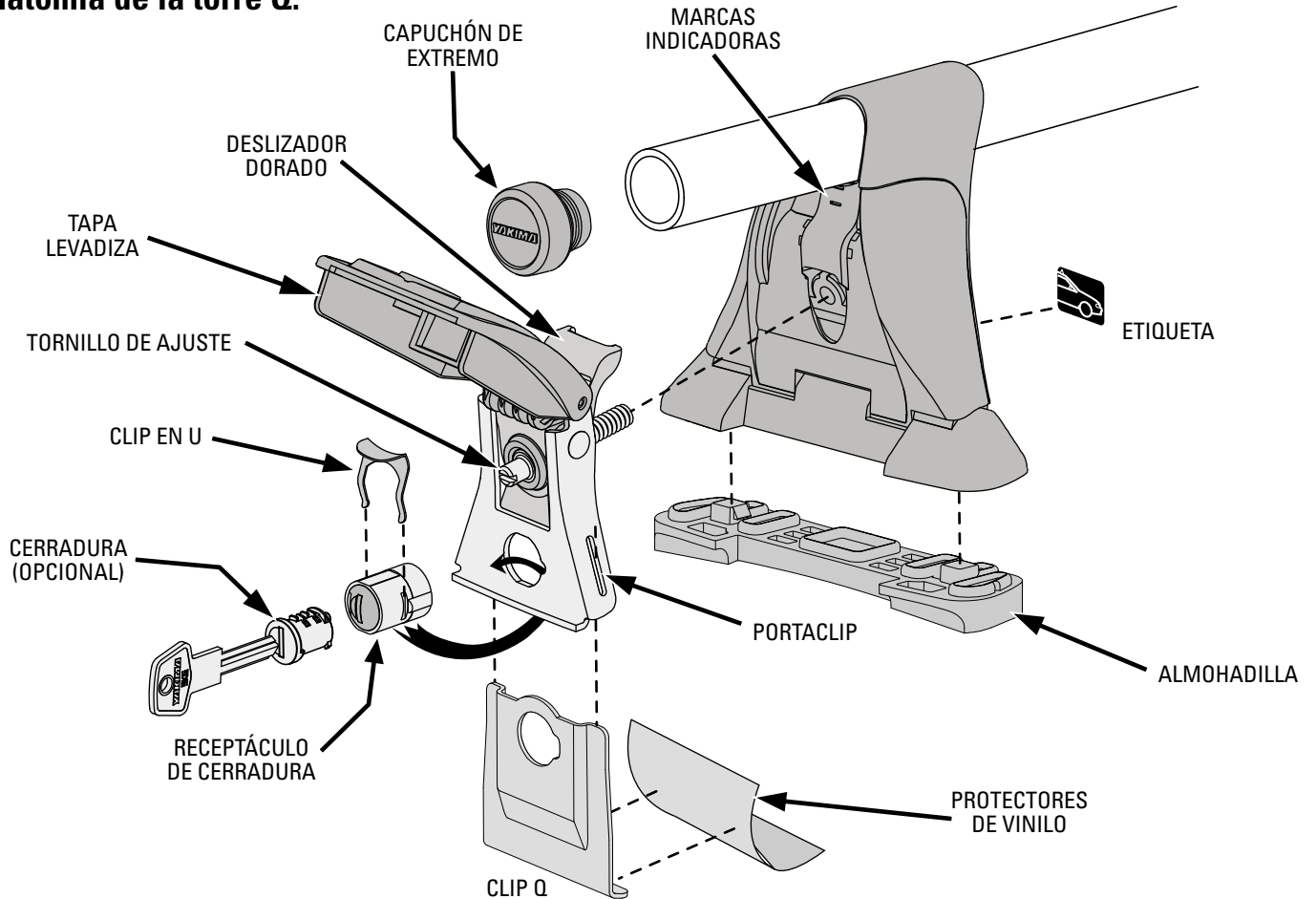

Familias de clips Q.

Existen diferentes formas y tamaños de clips Q, pero todos entran en las cinco categorías existentes. Cada vehículo necesita un clip Q específico para instalar las torres Q. Por esta razón esos clips se deben comprar por separado. Más abajo se ilustran ejemplos de las cinco categorías de clips Q que existen.

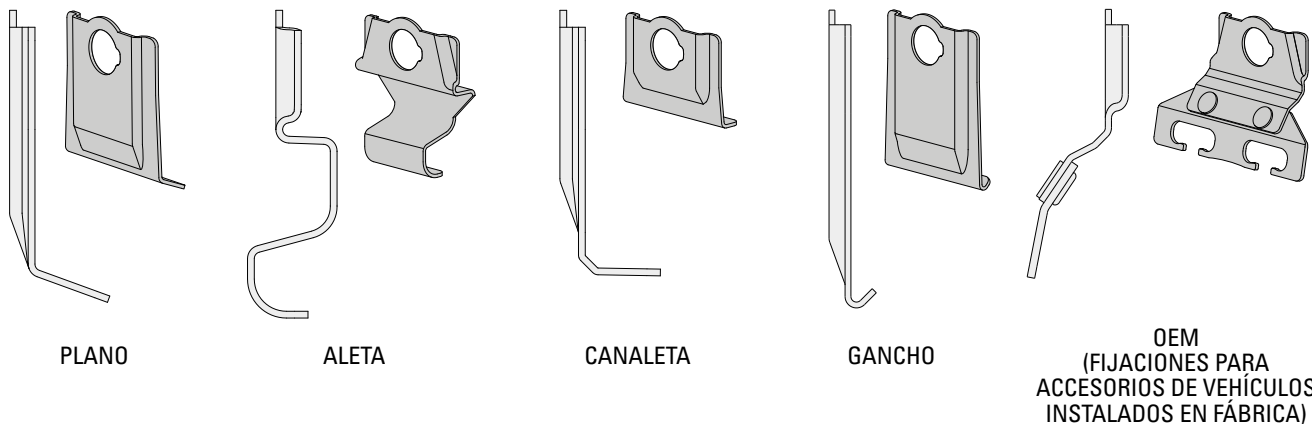

Vista del conjunto

Prepárese para la instalación

Instale las torres en la parte delantera

Instale las torres en la parte trasera

Verifique la seguridad de la instalación

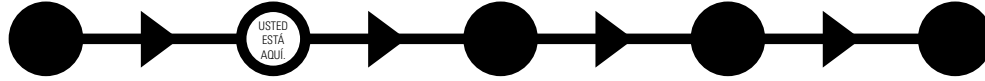

1 Retire las tapas.

Afloje los tornillos de ajuste para quitar las tapas de cada una de las cuatro torres.



2 Abra las torres.

Abra cada torre para tener acceso al tornillo que se encuentra en su interior.

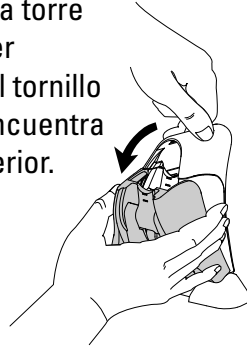

Afloje el tornillo de cada torre hasta que la barra transversal pase a través del orificio de la torre (vea la etapa siguiente).

3 Pase las barras a través de las torres.

Pase cada barra transversal a través del orificio de las dos torres.

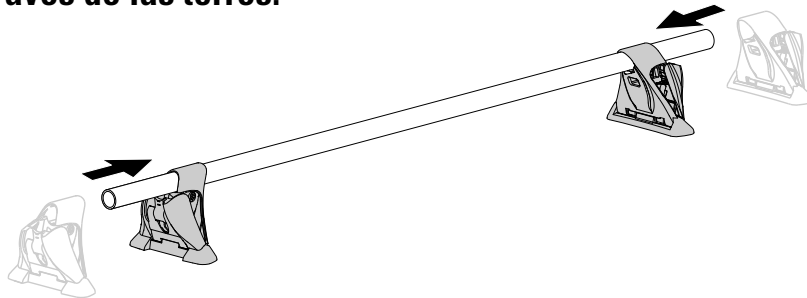

4 Busque las 4 medidas M de su vehículo.

Identifique las medidas que corresponden a su vehículo en la hoja de medidas de los clips Q.

MARCA	M1	M2	M3	M4

Anote las cuatro medidas en los espacios previstos a la derecha. Guarde estas instrucciones en un lugar seguro para futuras referencias.

Si su vehículo no se encuentra en la lista o si la hoja de clips no está en la caja de Clips Q, visite yakima.com/roof-rack-installation, comuníquese con un distribuidor o llame al 888-925-4621.

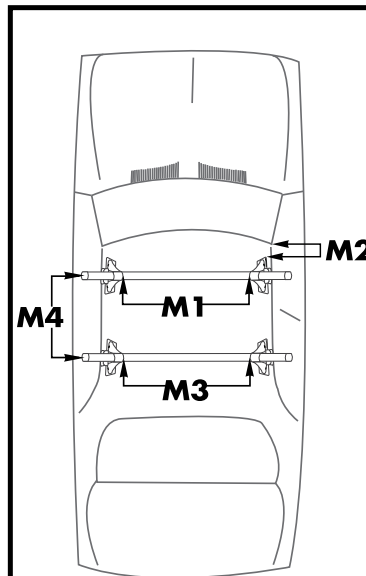

MI VEHÍCULO:

M1=

M2=

M3=

M4=



¿Usted desea instalar los pares de Q-Towers en la parte DELANTERA o en la parte TRASERA? Para la instalación en la parte DELANTERA pase a la etapa siguiente. Para la instalación en la parte TRASERA salte a la etapa 11.



5 Tome la medida M1 y centre la barra.

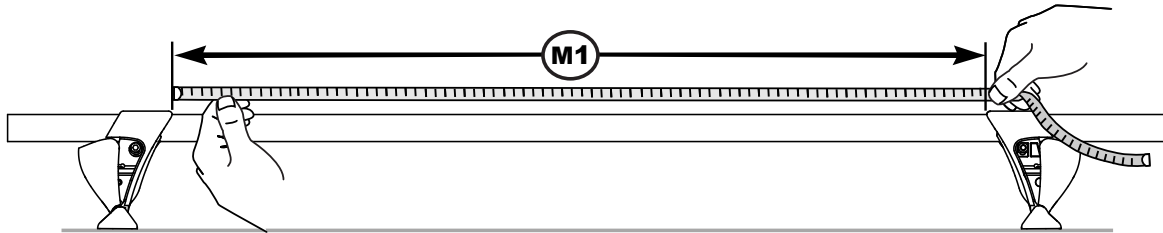

Nota: Tome las medidas sobre una superficie plana alejada del vehículo.



Estire bien la cinta métrica para obtener medidas exactas. La tolerancia de las medidas debe estar dentro de los 3,2 mm (1/8").

CONSEJO: Para centrar la barra transversal entre las torres después de fijar las medidas, utilice la técnica siguiente: Al mismo tiempo que empuja la barra hacia abajo y la hace rotar, ajústela lo necesario del lado izquierdo o derecho. Verifique dos veces la medida M1 y ajuste si es necesario.

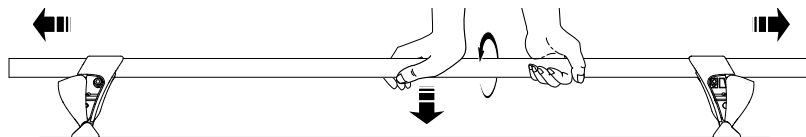

6 Ajuste el conjunto torre/barra transversal.



Asegúrese de no mover las torres.

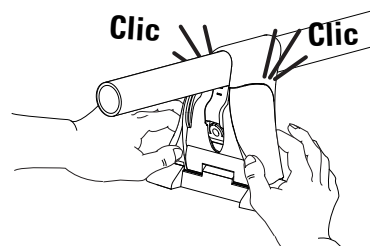
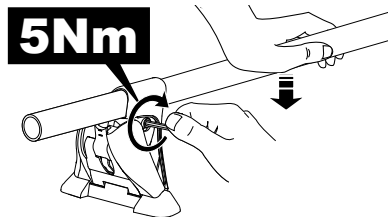

Cierre las cubiertas a presión.

7 Pegue las etiquetas en las torres.

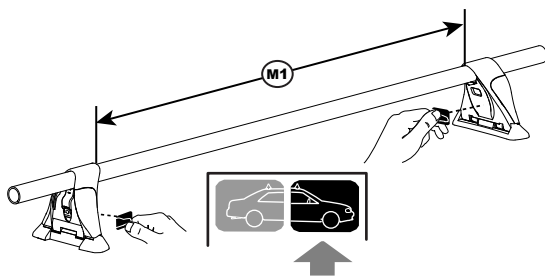

Identifique las torres con las etiquetas de la parte delantera del vehículo.

8 Instale los capuchones de los extremos y las almohadillas adecuadas.

Coloque las almohadillas adecuadas. En ciertos vehículos es necesario instalar almohadillas diferentes adelante (M1) y atrás (M3). La letra de cada almohadilla se encuentra en el centro de la misma.



Mantenga las almohadillas limpias y libres de partículas. Límpielas cada vez que sea necesario, manténgalas cuidadas y no las instale sobre superficies que no estén limpias.

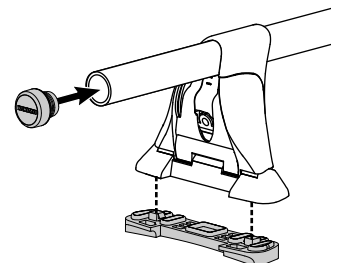

Vista del conjunto



Prepárese para la instalación



Instale las torres en la parte delantera



Instale las torres en la parte trasera



Verifique la seguridad de la instalación



9 Posicione las torres de la parte delantera.

- Limpie la parte del techo del vehículo en que se instalarán las torres.
- Apoye el conjunto torres/ barra sobre el techo.

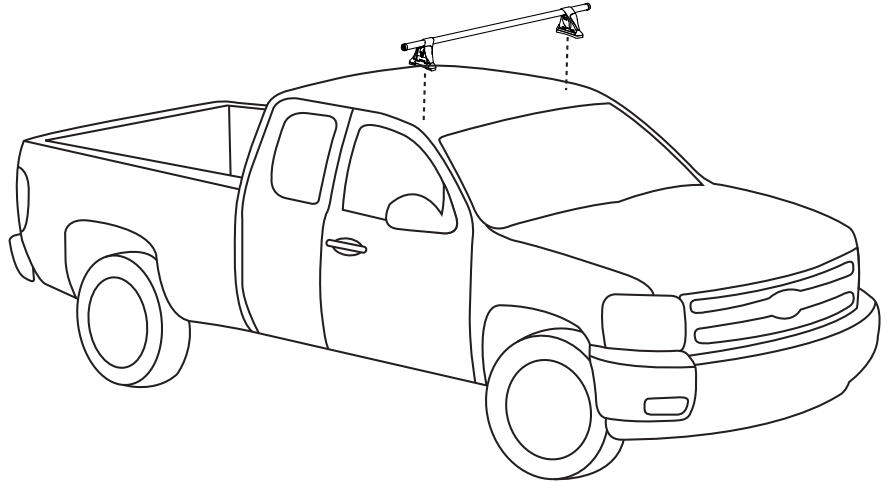

10 Fije la medida M2.

- UTILICE LA MEDIDA M2 que ya identificó en la etapa 4.
- Mida la distancia más corta que va del borde delantero de la base de la torre al ángulo más cercano formado por el techo y la parte exterior del ribete del parabrisas.
- Una vez que el sistema está posicionado, EVITE QUE SE MUEVA.

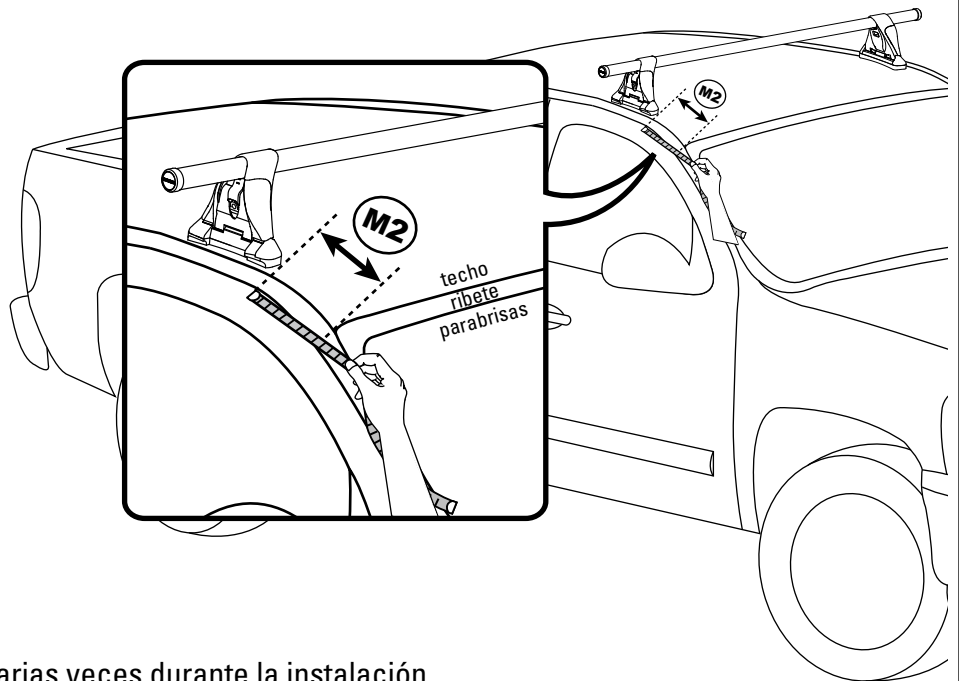

CONSEJO: Verifique esta medida varias veces durante la instalación.

Para continuar la instalación de las torres de adelante, salte a la etapa 17.



¿Usted desea instalar los pares de Q-Towers en la parte DELANTERA o en la parte TRASERA? Para la instalación en la parte DELANTERA pase a la etapa siguiente. Para la instalación en la parte TRASERA salte a la etapa 5.



11 Tome la medida M3 y centre la barra.

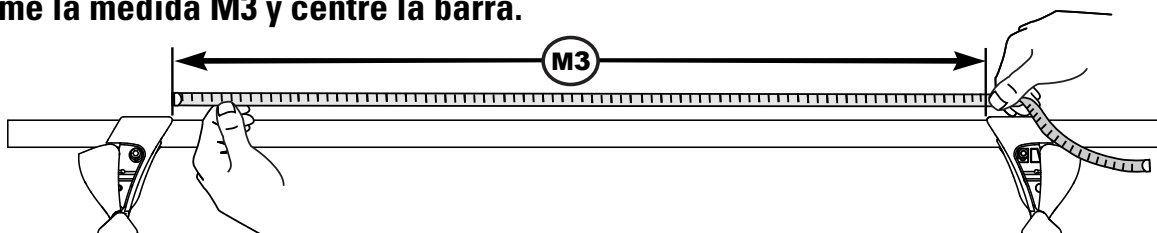

Nota: Tome las medidas sobre una superficie plana alejada del vehículo.



Estire bien la cinta métrica para obtener medidas exactas. La tolerancia de las medidas debe estar dentro de los 3,2 mm (1/8").

CONSEJO: Para centrar la barra transversal entre las torres después de fijar las medidas, utilice la técnica siguiente: Al mismo tiempo que empuja la barra hacia abajo y la hace rotar, ajústela lo necesario del lado izquierdo o derecho. Verifique dos veces la medida M3 y ajuste si es necesario.

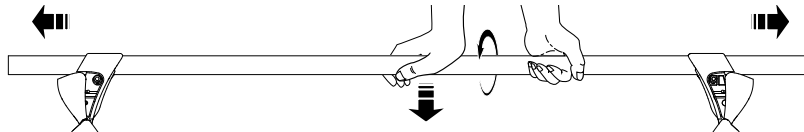

12 Ajuste el conjunto torre/barra transversal.



Asegúrese de no mover las torres.

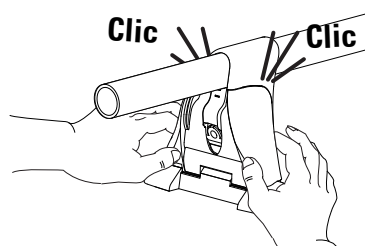
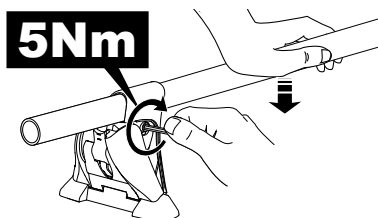

Cierre las cubiertas a presión.

13 Pegue las etiquetas en las torres.

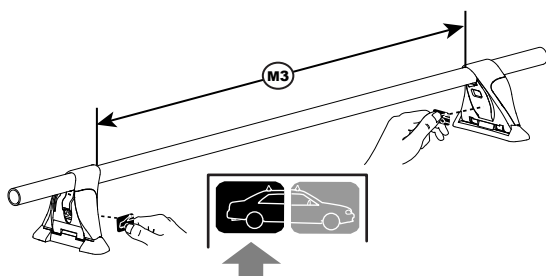

Identifique las torres con las etiquetas de la parte trasera del vehículo.

14 Instale los capuchones de los extremos y las almohadillas adecuadas.

Coloque las almohadillas adecuadas. En ciertos vehículos es necesario instalar almohadillas diferentes adelante (M1) y atrás (M3). La letra de cada almohadilla se encuentra en el centro de la misma.



Mantenga las almohadillas limpias y libres de partículas. Límpielas cada vez que sea necesario, manténgalas cuidadas y no las instale sobre superficies que no estén limpias.

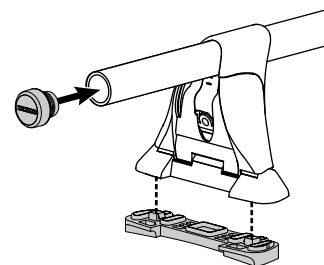

Vista del conjunto



Prepárese para la instalación



Instale las torres en la parte delantera



Instale las torres en la parte trasera



Verifique la seguridad de la instalación



15 Posicione las torres en la parte trasera.

- Limpie la parte del techo del vehículo en que se instalarán las torres.
- Apoye el conjunto torres/barra sobre el techo.

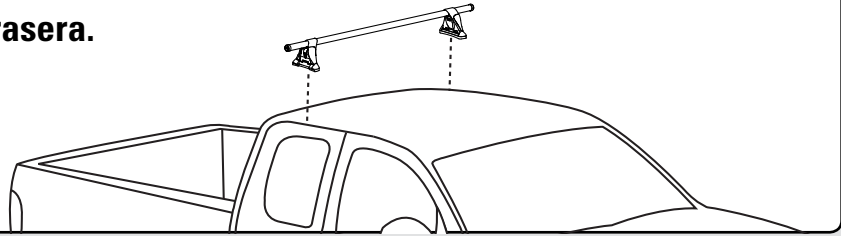

16 Fije las medidas

- Ajouter ensemble les mesures M2 et M4 (du feuillet qui accompagne les crochets).
- Mida la distancia más corta que va del borde delantero de la base de la torre al ángulo más cercano formado por el techo y la parte exterior del ribete del parabrisas.
- Una vez que el sistema está posicionado, EVITE QUE SE MUEVA.

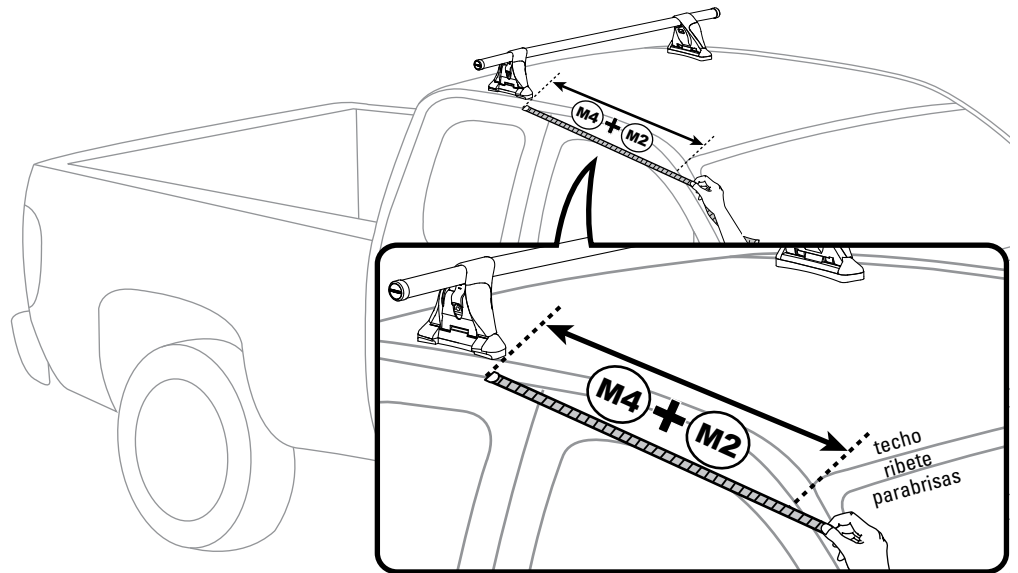

EJEMPLO:

TOYOTA	M1	M2	M3	M4	M2 = 6"
Tundra Access Cab 99-02	Q107-A 42 1/2"	6"	Q107-A 41 1/8"	32"	+ +
					M4 = 32"
Ubicación de las torres en la Tundra = 38"					

Las medidas correctas se pueden encontrar en la caja de los clips Q.

Si su vehículo no figura en la lista o si la hoja de medidas no está en la caja de los clips Q, verifique en Yakima.com, póngase en contacto con un distribuidor o llame al 888-925-4621.

17 Centre el conjunto trasero torres/barra sobre el vehículo.

Mida la distancia que va del cuadro de la puerta a la base de la torre correspondiente para centrar cada lado del conjunto torres/barra. La posición y la distancia en ambos lados deben ser iguales.

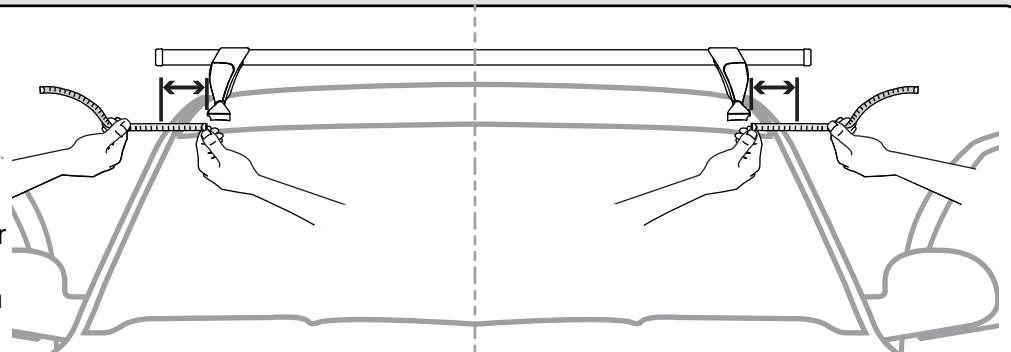

18 Instale los protectores de vinilo en los clips delanteros.

- Coloque las almohadillas negras de vinilo en los lugares en que el clip está en contacto con la pintura del vehículo. Corte el sobrante si es necesario.

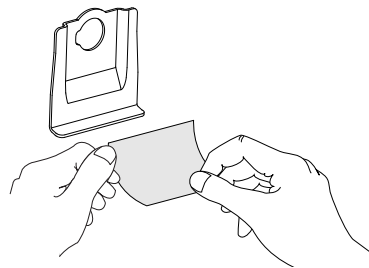

19 Arme los clips Q y los receptáculos de cerradura delanteros.

- Introduzca el clip apropiado en las ranuras del portacclip.
- Pase el receptáculo de la cerradura a través de los orificios del clip y del portacclip.

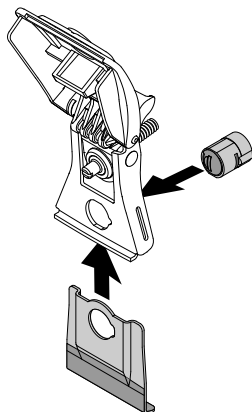

- Coloque el clip en U en el receptáculo de la cerradura para asegurar el conjunto.



20 Fije las tapas levadizas sin apretarlas.



¡NO MUEVA LAS TORRES!
Si las mueve, deberá posicionarlas nuevamente.

- Abra las puertas del lado conductor y del lado acompañante.
- Apriete con cuidado el tornillo de ajuste de la torre para que la tapa quede fijada pero no apretada (máximo de 2 vueltas).
- Repita la operación del otro lado del vehículo.

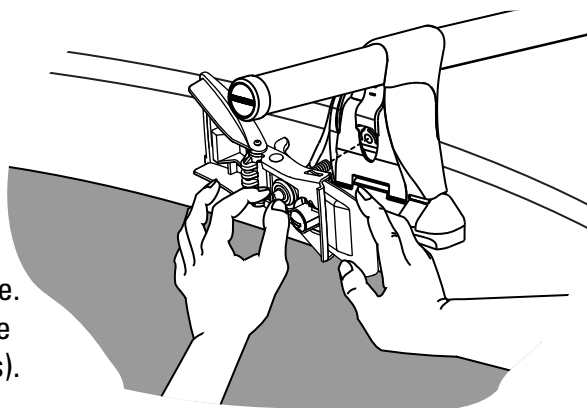

- Coloque cuidadosamente el clip contra el marco de la puerta. **NO MUEVA LAS TORRES.**
- Mientras sostiene el clip contra el marco de la puerta, utilice el tornillo de ajuste para ir reduciendo el juego del sistema hasta que la tapa levadiza se cierre **fácilmente. NO APRIETE COMPLETAMENTE.**
- Repita la operación del otro lado del vehículo.

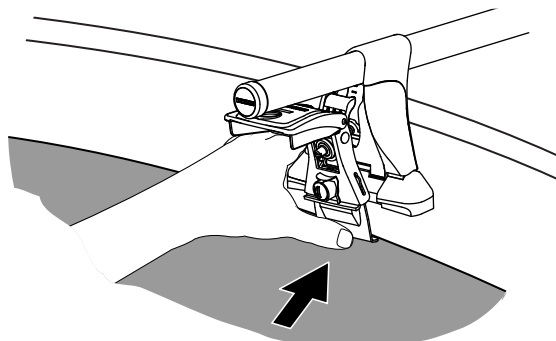

Verifique nuevamente la medida M2 (adelante) o M2 + M4 (atrás) y corríjalas si es necesario (etapa 10 para la instalación delantera)(etapa 18 para la instalación trasera).

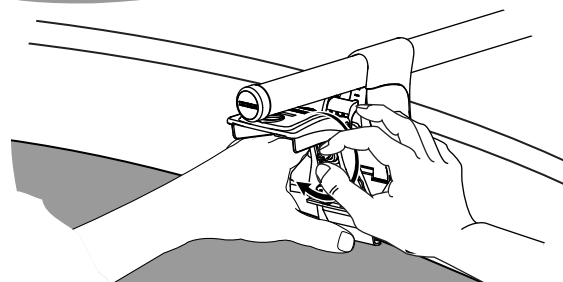

Instale el sistema.

21a El objetivo: Su instalación estará completa una vez que logre una tensión equilibrada en cada torre.

REQUISITOS PARA QUE LAS TENSIONES DE LAS TORRES QUEDEN EQUILIBRADAS

1. La tapa levadiza se cierra oponiendo una resistencia firme e igual en ambos lados del vehículo.
2. Las posiciones de los deslizadores dorados son iguales en ambos lados del vehículo. Observe las marcas indicadoras que se encuentran en la torre.
3. **Para los clips planos solamente:** La posición del deslizador dorado también debe estar **SOBRE O ENTRE** MARCAS INDICADORAS.

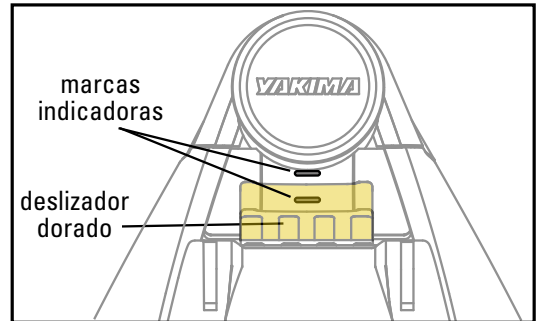

clips planos
(ver página 2)

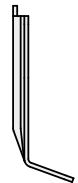

21b La técnica: Apriete lentamente las torres girando los tornillos de ajuste en sentido horario, una vuelta completa a la vez, alternando entre la torre del lado conductor y la del lado acompañante. **Cierre la tapa levadiza después de cada ajuste.** Sólo se puede abrir una tapa levadiza a la vez.

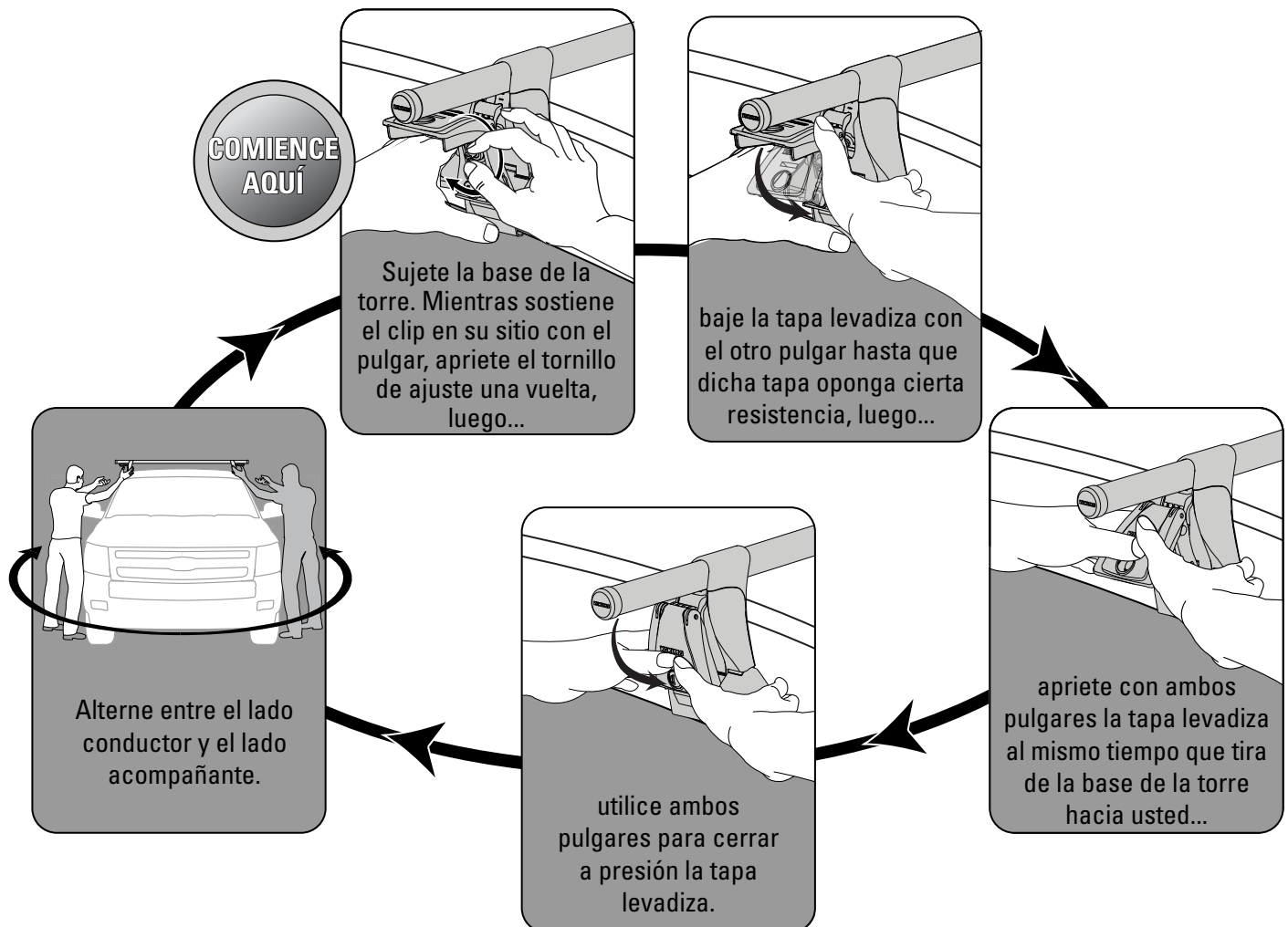

Aplique esta técnica del lado conductor y del lado acompañante de manera alternada hasta que logre que las tensiones de las torres queden equilibradas.

Vista del conjunto

Prepárese para la instalación

Instale las torres en la parte delantera

Instale las torres en la parte trasera

Verifique la seguridad de la instalación



USTED ESTÁ AQUÍ

22 Realice las verificaciones de seguridad con las puertas del vehículo abiertas.

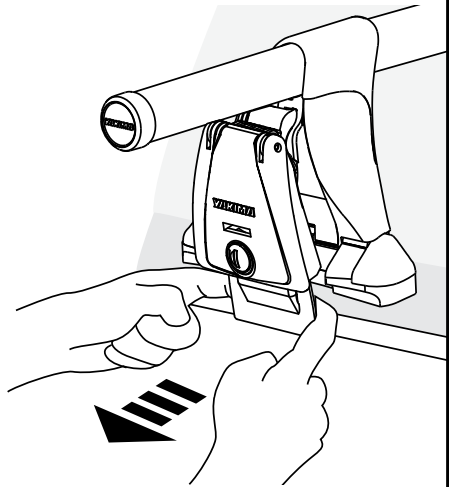

¡VERIFIQUE TODOS LOS CLIPS!

Tire de cada clip hacia afuera del vehículo. **¡TIRE CON FUERZA!**

Repita la operación. **El clip no se debe mover cuando pegue el segundo tirón.**

¡VERIFIQUE TODAS LAS TORRES! Aférrase a la barra del lado interior de las torres y luego empuje y tire con la fuerza del brazo solamente.

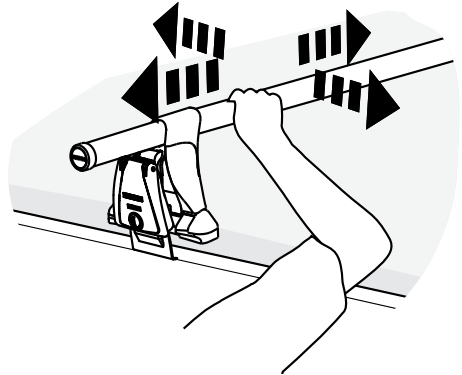

Si un clip o una torre continúan moviéndose, verifique las posiciones del deslizador dorado y apriete gradualmente los tornillos de ajuste (etapa 21b). Si después de este ajuste el movimiento sigue, revise la medida M1 (instalación delantera) o M3 (instalación trasera).

Una vez instalado, es fácil volver a armar o desarmar el sistema sin ninguna herramienta.

PARA RETIRAR EL CONJUNTO

Abra la cerradura de las torres y las tapas levadizas. Levante y retire el conjunto torres/barra, sin desarmarlo.

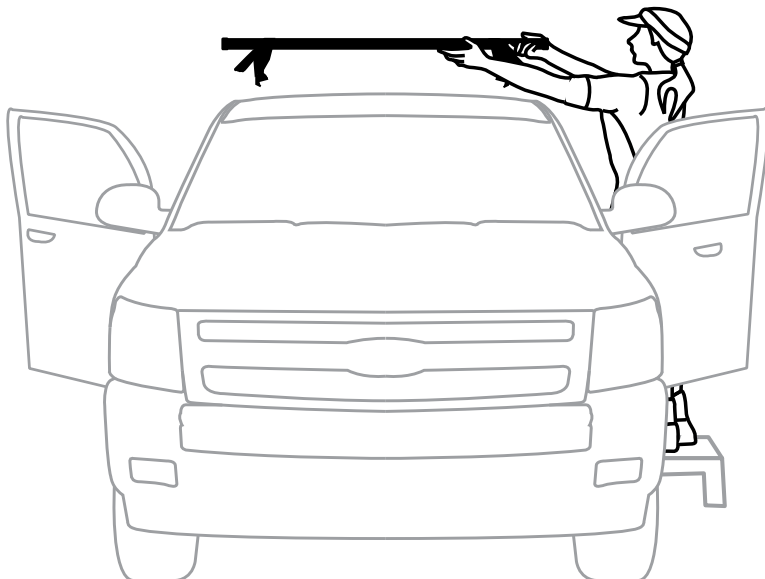

PARA VOLVER A INSTALAR EL CONJUNTO

- Abra las tapas levadizas.
- Limpie el techo y coloque las torres en las posiciones M2 (para la instalación delantera) o M4 + M2 (para la instalación trasera). Tome medidas precisas.
- Asegúrese de que los clips están instalados correctamente y luego cierre las tapas levadizas con firmeza. **¡VERIFIQUE LA SEGURIDAD DE TODAS LAS TORRES Y CLIPS DESPUÉS DE CADA INSTALACIÓN! (ETAPA 22).**



Si no se verifican los clips y las torres antes de partir, se pueden provocar daños materiales, heridas corporales o la muerte.

23

CIERRE LAS TORRES CON LLAVE.

Si compró cerraduras, siga las instrucciones para instalarlas.

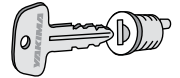

24

AMARRE LAS CARGAS LARGAS.

Las cargas que sobresalen del parabrisas (excepto las cajas para equipaje) deben amarrarse a las partes delantera y trasera del vehículo, así como al portaequipaje. De no hacerlo, se pueden ocasionar daños a la propiedad, lesiones o incluso la muerte.

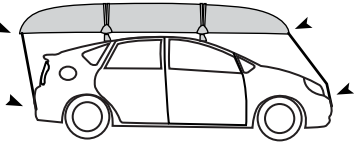

¡IMPORTANTE!

¡Asegúrese de leer toda la información sobre las advertencias y la garantía que acompañan estas instrucciones!

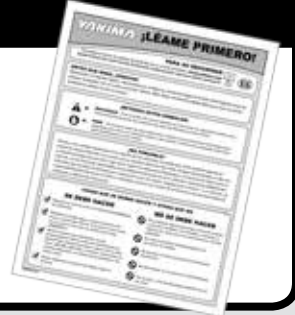

LÍMITES DE PESO



ESTE PRODUCTO
(7,5 LB/3,4 KG)

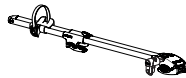

ALGUNOS ACCESORIOS



VEHICLEGA



No más de 165 lb (75 kg), a menos que se indique lo contrario.

CONSULTE LAS NOTAS DE LA HOJA DE CLIPS O VISITE EL SITIO YAKIMA.COM PARA CONOCER EL LÍMITE DE PESO DEL TECHO DE SU VEHÍCULO.

PORTEZUELA TRASERA

Ciertas cargas largas pueden impedir que la portezuela trasera se abra completamente.

ABRA SIEMPRE LA PORTEZUELA CON PRECAUCIÓN.

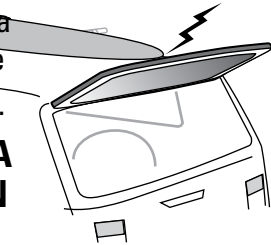

QUITE LOS ACCESORIOS ANTES DE ENTRAR EN UN LAVADERO AUTOMÁTICO DE VEHÍCULOS.

TECHO CORREDIZO

ABRA SIEMPRE EL TECHO CORREDIZO CON PRECAUCIÓN.

El techo corredizo puede dificultar la instalación de ciertos accesorios o barras transversales.

PORTAEQUIPAJES DE FÁBRICA

Si el vehículo está equipado con un portaequipajes de origen, éste puede interferir con ciertos accesorios.

ANTENA

Quizá sea necesario quitar la antena del techo para evitar interferencias con los portaequipajes o las vehiclegas largas.



ADVERTENCIA: Cerciórese de que todo el equipo está asegurado según las instrucciones. Las piezas de fijación se pueden aflojar con el tiempo. Verifique antes de cada uso y ajuste si es necesario.

¡ CONSERVE ESTAS INSTRUCCIONES !