

NOTE: CROSSBAR SPREAD IS FIXED.

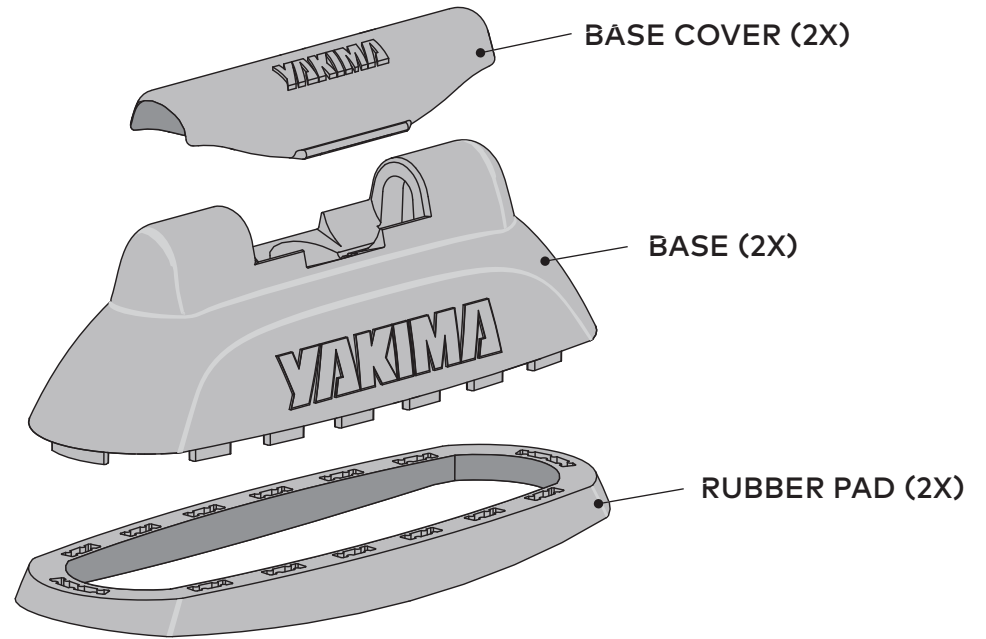

### INCLUDED TOOL

5 MM ALLEN WRENCH



### M7 HARDWARE BAG

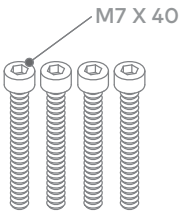

M7X40 hardware (PN 8880281) not included with Landing Pad 11. To order your M7X40 hardware, contact Yakima Customer Service at (888) 925-4621 Monday through Friday, 7:00 AM to 5:00 PM, PST. Please allow 3-5 business days for delivery.

### M6 HARDWARE BAG

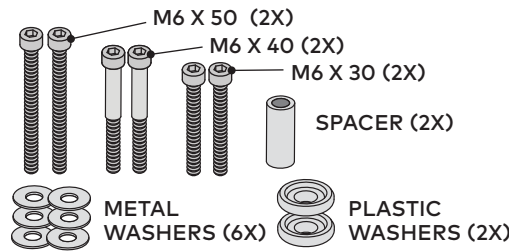

### M8 HARDWARE BAG

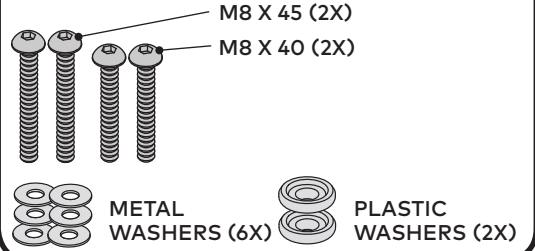

REFER TO YAKIMA SKYLINE OR CONTROL TOWER INSTRUCTIONS FOR IMPORTANT WARNING AND LOAD LIMITATIONS, AND YAKIMA'S LIMITED WARRANTY.



**1**

**IF YOUR VEHICLE HAS FACTORY CROSSBARS, REMOVE THEM NOW, THEN PROCEED TO STEP 3.**

**2**

**OPEN THE COVER-PLATES.**

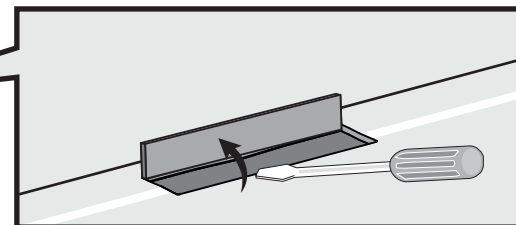
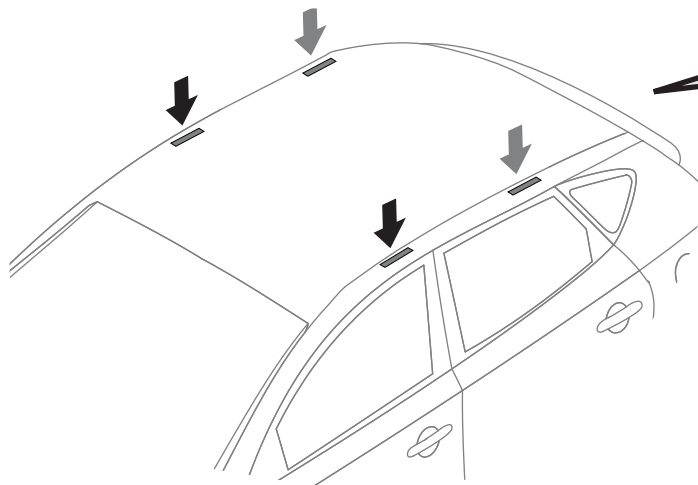

Consult your vehicle's owner's manual to determine how your cover plates are opened or removed. This will vary from vehicle to vehicle.

**3**

**DETERMINE YOUR HARDWARE AND PREPARE THREADS.**

 Refer to the fit chart on page 5 (or online at [yakimatech.com](http://yakimatech.com) if your vehicle is not listed) to determine the correct hardware for your vehicle.

Be sure the threads are clear of paint by carefully threading your fastener in and out of the hole a few times while blowing away any debris that accumulates.

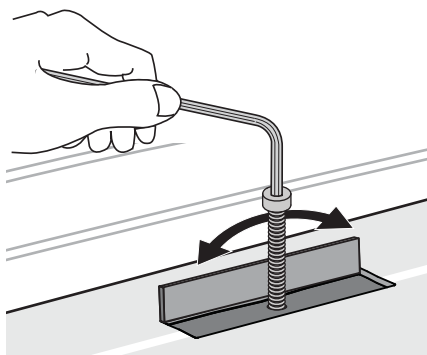

**NOTE:** If there are multiple holes in each pocket, use the rear-most holes.

**NOTE:** Some vehicles have a plug in the threads which must be removed.

**4**

**REMOVE THE COVERS.**

Remove the covers from the bases.

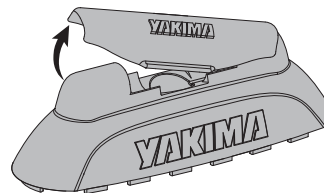

When the racks are not installed, use the covers to keep the bases free of debris.

**5**

**INSTALL PADS TO BASES.**

Attach each pad to each base.

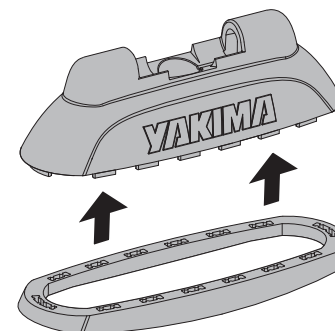

## 6 ATTACH LANDING PADS.



Refer to the fit chart on page 5 (or online at [yakimatech.com](http://yakimatech.com) if your vehicle is not listed) to determine the correct hardware for your vehicle.

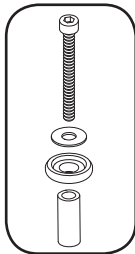

Use M6 spacer if required for your vehicle.

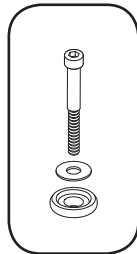

M6 Hardware

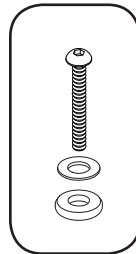

M8 Hardware



**BE SURE TO USE THE CORRECT LENGTH OF HARDWARE!**

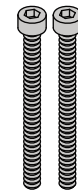

M6 X 50

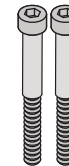

M6 X 40



M6 X 30

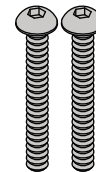

M8 X 45

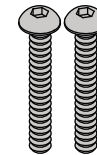

M8 X 40

- Put Landing Pad in place on a clean and dry rooftop.
- Stack metal washer on top of plastic washer with convex side of plastic washer facing down. Add washers as needed to prevent bolt from bottoming out.
- Put fastener through washers, through Landing Pad, and thread into threaded mounting point in rooftop.
- Thread the fastener, and tighten with short handle as shown, but do not fully tighten. **USE CAUTION NOT TO CROSS THREAD FASTENER.**
- Jostle and rotate Landing Pad in all directions to ensure plastic washer is fully seated, also allowing Landing Pad a small amount of play to prepare for final alignment and tightening in step 7.
- Repeat for second Landing Pad.



**WARNING: DO NOT ALLOW EDGES OF PAD TO CURL UNDER!**

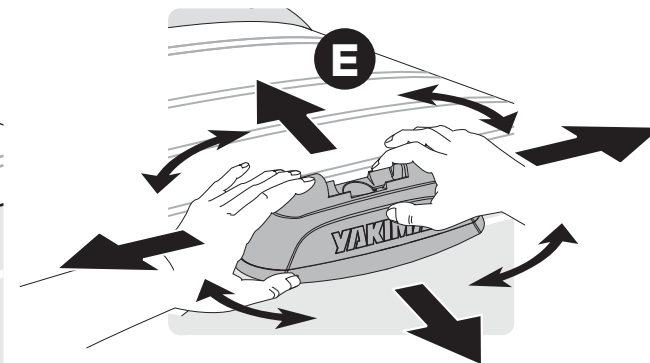
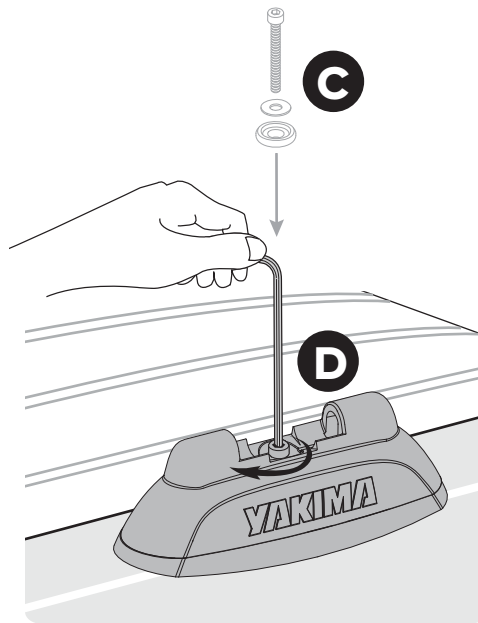
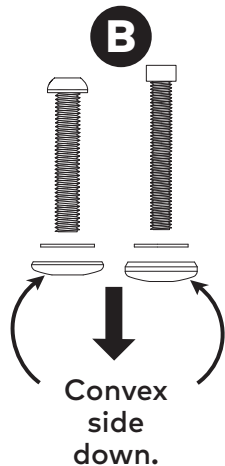
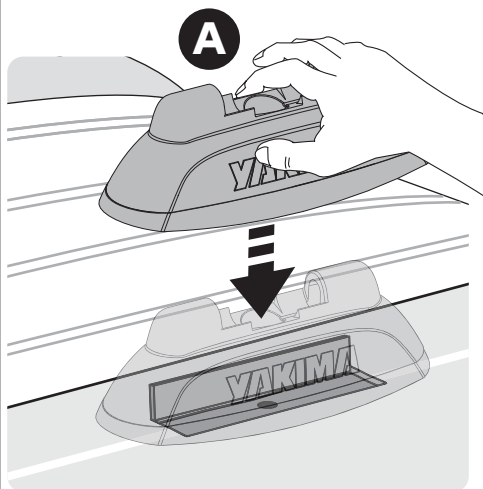
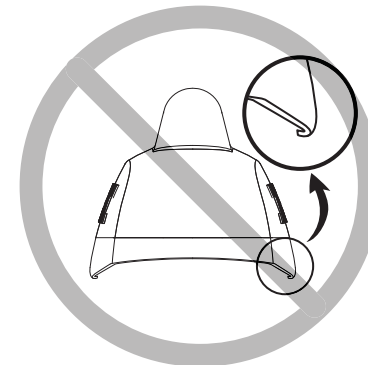

**NOTE: Final tightening will happen in the next step.**

## 7 ADJUST LANDING PAD POSITIONS THEN TIGHTEN THEM DOWN.

- Using your tower instructions as a reference, carefully place an assembled crossbar with towers onto the Landing Pads.
- Align position of Landing Pads to allow SkyLine or Control Towers to fully close.
- Center crossbars and fully torque your SkyLine or Control towers to the crossbars according to the tower instructions.

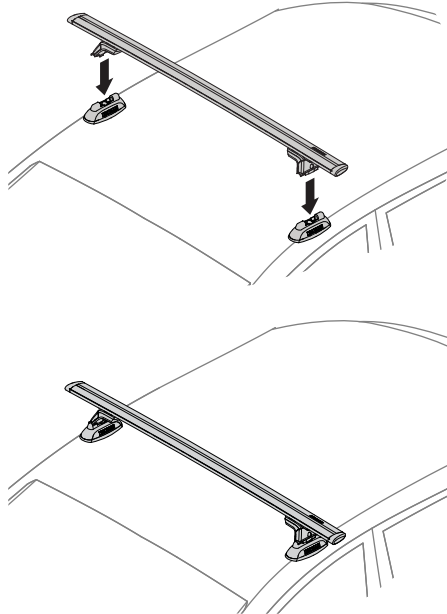

- Open one SkyLine or Control Tower cover and lift it up while opposite tower is still engaged.
- While holding SkyLine or Control Tower above Landing Pad, fully tighten Landing Pad with long handle as shown. If your vehicle requires spacers torque to 27 in-lbs (3 Nm). DO NOT OVER TIGHTEN AS DAMAGE TO ROOF MOUNTING POINTS MAY OCCUR.
- Repeat the process again for the other Landing Pads to ensure they have not changed position.
- Re-insert SkyLine or Control Tower into the Landing Pad, fully tighten the tower (refer to tower instructions) and close the cover.

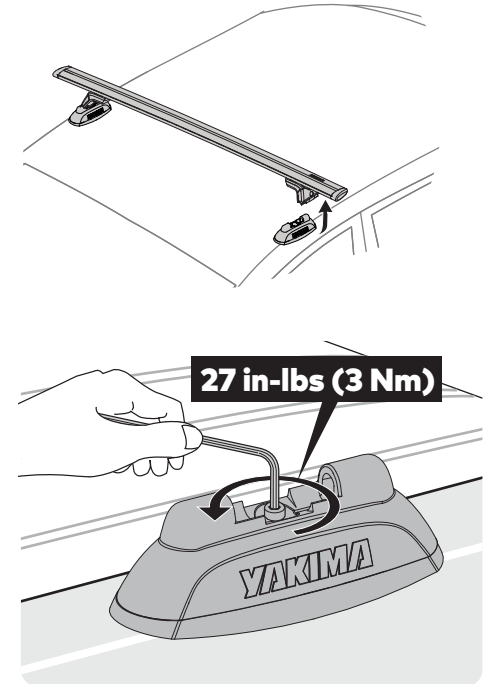

**NOTE:** Due to manufacturing variations the fastening hardware may bottom out in the hardpoint before the Landing Pad is fully tight. If you encounter this situation, go back to step 6 and re-install with additional metal washer(s) (up to 3) to take up the slack.

## 8 READ THESE WARNINGS!



Make sure SkyLine or Control Towers, with bars installed, seat completely with Landing Pad. If they do not seat properly, repeat step 7.



Be sure all hardware is secured according to instructions. Failure to perform safety checks before driving away can result in property damage, personal injury, or death.

Attachment hardware can loosen over time. Check and tighten if necessary, before each use.

To avoid damage to your vehicle's finish remove and clean Landing Pads and mounting points periodically as road sediment will accumulate over time.



### DO NOT EXCEED MAXIMUM WEIGHT LIMIT FOR YOUR VEHICLE.

To review your vehicle's specific weight limit and load limitations for accessories, visit [yakimatech.com](http://yakimatech.com).

For additional product support, visit [yakima.com/support](http://yakima.com/support) or contact us directly at (888)925-4621 Monday through Friday, 7:00 AM to 5:00 PM, PST.

**Remove your YAKIMA rack and accessories before entering automatic car washes.**

## 9 CONTINUE WITH SKYLINE OR CONTROL TOWER INSTALLATION.



# LANDING PAD 11 FIT NOTES

Look at the notes that apply to your vehicle. (pages 25-33)



		HARDWARE/LENGTH	QTY. FRONT WASHERS	QTY. REAR WASHERS	M6 SPACER REQUIRED	MAX WEIGHT	
<b>BMW</b>							
1 Series 2dr	08-13	M6x40	1	1		165 lbs./75 kg	1,2,5,14,47,54,64,81,82,109,110,187,191,197,601
2 Series 2dr	14-19	M6x40	1	1	Yes	165 lbs./75 kg	1,2,5,14,40,45,47,81,82,109,110,143,187,191,601
3 Series 2dr	00-06	M6x40	1	1		165 lbs./75 kg	1,2,5,14,47,54,64,81,82,100,109,110,187,191,197,601
3 Series 4dr	06-11	M6x40	1	1	Yes	165 lbs./75 kg	1,2,5,14,40,45,47,81,82,109,110,143,187,191,601
3 Series 4dr	12-18	M6x40	1	1	Yes	165 lbs./75 kg	1,2,5,14,40,45,47,81,82,109,110,143,187,191,601
3 Series 4dr	99-05	M6x40	1	1		165 lbs./75 kg	1,2,5,14,47,54,64,81,82,100,109,110,187,191,197
3 Series Wagon	11-12	M6x40	1	1	Yes	165 lbs./75 kg	1,2,5,14,40,45,47,54,69,81,82,100,109,110,132,143,187,191,197,601
3 Series Gran Turismo 5dr	14-19	M6x40	1	1	Yes	165 lbs./75 kg	1,2,5,14,40,45,47,81,82,109,110,132,143,187,191,601
4 Series 2dr	14-19	M6x40	1	1	Yes	100 lbs./45 kg	1,2,5,14,40,45,47,81,82,109,110,143,187,191,601
4 Series Gran Coupe 4dr	15-19	M6x40	1	1	Yes	165 lbs./75 kg	1,2,5,14,40,45,47,81,82,100,109,110,143,187,191,197,601
5 Series 4dr	97-03	M6x40	1	1		165 lbs./75 kg	1,2,5,14,47,54,64,81,82,109,110,187,191,197,601
5 Series 4dr	11-16	M7x40	3	3		165 lbs./75 kg	2,5,14,39,54,64,81,82,109,110,191,197,601
5 Series Gran Turismo 5dr	10-19	M6x40	1	1		165 lbs./75 kg	1,2,5,14,47,61,64,69,81,82,109,110,132,187,191,197,601
<b>CHEVROLET</b>							
City Express 5dr	15-18	M8x40	1	1		165 lbs./75 kg	2,5,14,18,49,51,64,81,84,85,86,100,104,107,109,110,164,165,191,601
<b>FORD</b>							
Flex 5dr	09-19	M6x50	1	1		165 lbs./75 kg	04,107,109,110,164,165,191,601
Transit Connect 5dr	10-13	M8x40	1	1		165 lbs./75 kg	2,5,14,18,49,64,81,84,85,86,109,110,164,165,191,194,601
<b>HYUNDAI</b>							
Accent 5dr	12-17	M6x40	1	1		165 lbs./75 kg	2,5,14,47,64,69,81,82,107,109,110,132,164,191,197,601
Elantra GT 5dr	13-17	M6x50	4	4		150lbs./68 kg	2,5,14,41,48,54,64,69,81,82,109,113,132,187,191,197,601
i-25 5dr	12-13	M6x40	1	1		165 lbs./75 kg	2,5,14,46,64,81,82,107,109,110,164,191,601
<b>KIA</b>							
Soul 5dr	14-19	M6x50	1	1		165 lbs./75 kg	1,2,5,14,48,64,69,81,82,109,113,132,187,191,197,601
<b>LAND ROVER</b>							
LR4 5dr	10-16	M6x40	1	1		165 lbs./75 kg	2,5,14,47,51,64,69,81,82,100,104,109,110,132,164,165,191,601
Range Rover 5dr	03-12	M8x45	1	1		165 lbs./75 kg	2,5,14,50,51,64,81,82,100,104,109,110,140,187,191,197,601



# LANDING PAD 11 FIT NOTES

Look at the notes that apply to your vehicle. (pages 25-33)



		HARDWARE/LENGTH	QTY. FRONT WASHERS	QTY. REAR WASHERS	M6 SPACER REQUIRED	MAX WEIGHT	
<b>MAZDA</b>							
2 5dr	11-15	M6x40	3	3		165 lbs./75 kg	1,2,5,14,47,64,81,82,109,110,132,187,191,197,601
3 4dr	04-09	M6x40	1	2		165 lbs./75 kg	1,2,5,14,47,52,54,64,81,82,109,110,187,191,197,601
3 4dr	10-13	M6x40	1	1		165 lbs./75 kg	1,2,5,14,47,52,54,64,81,82,109,110,187,191,601
3 4dr	14-18	M6x40	1	1		165 lbs./75 kg	1,2,5,14,47,52,54,64,81,82,100,109,110,187,191,197,601
3 5dr	04-09	M6x40	1	1		165 lbs./75 kg	1,2,5,14,47,52,54,64,69,81,82,109,110,132,187,191,197,601
3 5dr	10-13	M6x40	1	1		165 lbs./75 kg	1,2,5,14,47,52,54,64,69,81,82,109,110,132,187,191,601
3 5dr	14-18	M6x40	1	1		165 lbs./75 kg	1,2,5,14,47,52,54,64,69,81,82,100,109,110,132,187,191,197,601
3 5dr	16-17	M6x30	1	1		165 lbs./75 kg	2,5,14,46,54,64,69,81,82,100,109,110,132,191
5 5dr	06-10	M6x30	1	1		165 lbs./75 kg	2,5,14,46,64,69,81,82,100,109,110,132,144,164,191,197
5 5dr	12-15	M6x30	1	1		165 lbs./75 kg	2,5,14,46,54,64,69,81,82,100,109,110,132,191
6 4dr	14-18	M6x40	1	1		165 lbs./75 kg	1,2,5,14,47,52,64,81,82,98,100,109,110,187,191,601
CX-3 5dr	16-19	M6x40	1	1		165 lbs./75 kg	1,2,5,14,47,52,54,64,69,81,82,100,109,110,132,187,191,601
CX-5 5dr	13-16	M6x30	1	1		165 lbs./75 kg	2,5,14,18,47,54,64,69,81,84,85,88,100,109,110,140,164,165,191,197,601
CX-7 5dr	07-12	M6x40	1	1		126 lbs./57 kg	1,2,5,14,47,54,61,69,81,109,113,140,187,191,197,601
CX-9 5dr	07-15	M6x40	2	2		165 lbs./75 kg	2,5,14,18,47,51,54,64,69,81,84,88,100,104,109,110,140,164,165,191,197,601
Protegé 5 5dr	02-03	M6x40	1	1		165 lbs./75 kg	1,2,5,14,47,64,69,81,82,100,109,110,132,144,187,191,197,601
Speed3 5dr	04-09	M6x40	1	1		165 lbs./75 kg	1,2,5,14,47,52,54,64,69,81,82,109,110,132,187,191,197,601
Speed3 5dr	10-13	M6x40	1	1		165 lbs./75 kg	1,2,5,14,47,52,54,64,69,81,82,109,110,132,187,191,197,601
<b>MERCEDES</b>							
B-Class 5dr	05-11	M6x40	1	1		165 lbs./75 kg	2,5,14,47,64,69,81,82,109,110,132,144,191,197,601
C-Class 2dr	12-15	M8x40	1	1		165 lbs./75 kg	2,5,14,49,54,64,81,82,109,110,187,191,197,601
C-Class 4dr	08-14	M8x40	1	1		165 lbs./75 kg	2,5,14,49,54,64,81,82,109,110,187,191,197,601
C-Class 4dr	15-19	M8x40	1	1		165 lbs./75 kg	2,5,14,49,64,81,82,100,109,113,143,187,191,601
CLS-Class 4dr	06-11	M8x40	2	1		165 lbs./75 kg	1,2,5,14,49,54,64,81,82,100,109,110,187,191,197,601
CLS-Class 4dr	12-18	M8x40	2	1		165 lbs./75 kg	1,2,5,14,49,54,64,81,82,109,110,187,191,197,601
E-Class 2dr	10-17	M8x40	1	1		165 lbs./75 kg	2,5,14,49,64,81,82,109,110,187,191,197,601
E-Class 4dr	03-09	M6x40	1	1		165 lbs./75 kg	2,5,14,47,54,64,81,82,109,110,187,191,197,601
E-Class 4dr	10-16	M8x40	1	1		165 lbs./75 kg	2,5,14,49,64,81,82,109,110,187,191,197,601
E-Class 4dr	17-18	M8x45	2	2		165 lbs./75 kg	2,5,14,50,54,64,81,82,100,109,110,191,601
GLC Coupe 5dr	17-18	M8x40	1	2		165 lbs./75 kg	2,5,14,49,54,64,69,81,82,100,109,110,132,187,191
R-Class 5dr	06-12	M8x40	1	1		165 lbs./75 kg	2,5,14,49,54,64,81,82,109,110,140,187,191,197,601



# LANDING PAD 11 FIT NOTES

Look at the notes that apply to your vehicle. (pages 25-33)

		HARDWARE/LENGTH	QTY. FRONT WASHERS	QTY. REAR WASHERS	M6 SPACER REQUIRED	MAX WEIGHT	
<b>MERCEDES</b>							
S-Class 4dr	07-13	M6x40	1	1		165 lbs./75 kg	2,5,14,49,54,64,81,82,100,109,110,187,191,197,601
<b>MITSUBISHI</b>							
Lancer Sportback 5dr	10-14	M6x40	1	1		165 lbs./75 kg	1,2,5,14,47,64,69,81,82,109,110,132,144,187,191,197,601
Outlander 5dr	10-13	M6x40	1	1		165 lbs./75 kg	1,2,5,14,47,54,64,69,81,82,100,109,110,132,187,191,197,601
Outlander 5dr	16-19	M6x40	1	1		165 lbs./75 kg	1,2,5,14,47,64,69,81,82,109,110,132,187,191,601
Outlander Sport 5dr	11-15	M6x40	1	1		165 lbs./75 kg	1,2,5,14,47,54,64,69,81,82,100,109,110,132,187,191,197,601
Outlander Sport 5dr	16-19	M6x40	1	1		165 lbs./75 kg	1,2,5,14,47,64,69,81,82,100,109,110,132,187,191,601
RVR 5dr	10-13	M6x40	1	1		165 lbs./75 kg	1,2,5,14,47,54,64,69,81,82,109,110,132,187,191,197,601
<b>NISSAN</b>							
NV200 5dr	13-19	M8x40	1	1		165 lbs./75 kg	2,5,14,18,49,51,64,81,84,85,86,100,104,109,110,164,165,191,197,601
<b>PORSCHE</b>							
911 2dr	05-12	M6x50	1	1		165 lbs./75 kg	2,14,48,54,64,81,82,100,110,187,601
Cayman 3dr	07-12	M6x50	1	1		125lbs./57 kg	2,14,48,54,64,81,82,110,187,601
Panamera 5dr	10-16	M6x50	1	1		165 lbs./75 kg	2,5,14,48,54,64,69,81,82,109,110,132,191,194,197,601
<b>RAM</b>							
Promaster City Dual sliding drs	15-19	M6x40	1	1		165 lbs./75 kg	2,5,14,47,64,81,82,98,100,104,109,110,132,191,601
<b>SAAB</b>							
9-3 Wagon	06-12	M6x50	1	1		165 lbs./75 kg	1,2,5,14,48,54,64,69,81,82,100,109,110,140,187,191,197,601
<b>SATURN</b>							
Astra 3dr	08-09	M6x40	1	1		165 lbs./75 kg	1,2,5,14,47,54,64,69,81,82,100,109,110,140,187,191,197,601
Astra 5dr	08-09	M6x40	1	1		165 lbs./75 kg	1,2,5,14,47,54,64,69,81,82,100,109,110,140,187,191,197,601
<b>SUBARU</b>							
Forester 5dr	11-11	M6x40	1	1		165 lbs./75 kg	1,2,5,14,47,54,64,69,81,82,109,110,132,187,191,197,601
Forester 5dr	09-13	M6x40	1	1		165 lbs./75 kg	1,2,5,14,47,54,64,69,81,82,100,109,110,132,187,191,197
Forester 5dr	14-18	M6x40	1	1		165 lbs./75 kg	2,5,14,47,54,64,69,81,82,109,110,132,164,191,197,601
Impreza 4dr	08-11	M6x40	1	1		165 lbs./75 kg	2,5,14,47,54,64,81,82,100,109,110,187,191,197
Impreza 4dr	17-19	M6x40	1	1		165 lbs./75 kg	2,5,14,47,54,64,81,82,100,104,109,110,191,601
Impreza 5dr	12-16	M6x40	1	1		165 lbs./75 kg	2,5,14,47,54,64,69,81,82,100,109,110,140,187,191,197,601



# LANDING PAD 11 FIT NOTES

Look at the notes that apply to your vehicle. (pages 25-33)



		HARDWARE/LENGTH	QTY. FRONT WASHERS	QTY. REAR WASHERS	M6 SPACER REQUIRED	MAX WEIGHT	
<b>SUBARU</b>							
Impreza 5dr	08-11	M6x40	1	1		165 lbs./75 kg	2,5,14,47,54,64,69,81,82,109,110,140,187,191,197
Impreza 5dr	17-19	M6x40	1	1		165 lbs./75 kg	2,5,14,47,54,64,81,82,100,109,110,132,187,191,601
Impreza WRX/STI 4dr	08-11	M6x40	1	1		165 lbs./75 kg	2,5,14,47,54,64,81,82,109,110,187,191,197,601
Impreza WRX/STI 5dr	08-14	M6x40	1	1		165 lbs./75 kg	2,5,14,47,54,64,81,82,100,109,110,187,191,197,601
Impreza WRX/STI 5dr	08-14	M6x40	1	1		165 lbs./75 kg	2,5,14,47,54,64,69,81,82,100,109,110,140,187,191,197,601
Outback Sport 5dr	08-11	M6x40	1	1		165 lbs./75 kg	2,5,14,47,54,64,69,81,82,100,109,110,140,187,191,197
Tribeca 5dr	06-07	M6x40	1	1		165 lbs./75 kg	2,5,14,18,47,54,64,69,81,84,85,86,100,109,110,140,164,165,191,197,601
Tribeca 5dr	08-14	M6x40	1	1		165 lbs./75 kg	2,5,14,18,47,54,64,69,81,84,85,86,100,109,110,140,164,165,191,197,601
WRX/STI 4dr	18-19	M6x40	1	1		165 lbs./75 kg	2,5,11,14,47,64,81,82,104,109,110,132,187,191
<b>SUZUKI</b>							
Kizashi 4dr	10-13	M6x40	1	1		165 lbs./75 kg	2,5,14,47,64,81,82,100,109,110,164,191,197,601
<b>TESLA</b>							
Model S w/ Panoramic Roof 4dr	12-14	M8x40	1	1		165 lbs./75 kg	2,5,14,49,64,81,82,107,109,112,132,164,191,197,601
Model S w/ Panoramic Roof 4dr	15-18	M6x40	1	1		165 lbs./75 kg	2,5,14,47,64,81,82,107,109,112,132,162,164,191,197,601
<b>VOLVO</b>							
V40 5dr	99-04	M6x30	1	1		165 lbs./75 kg	2,5,14,46,54,64,69,81,82,100,104,109,110,132,191,601



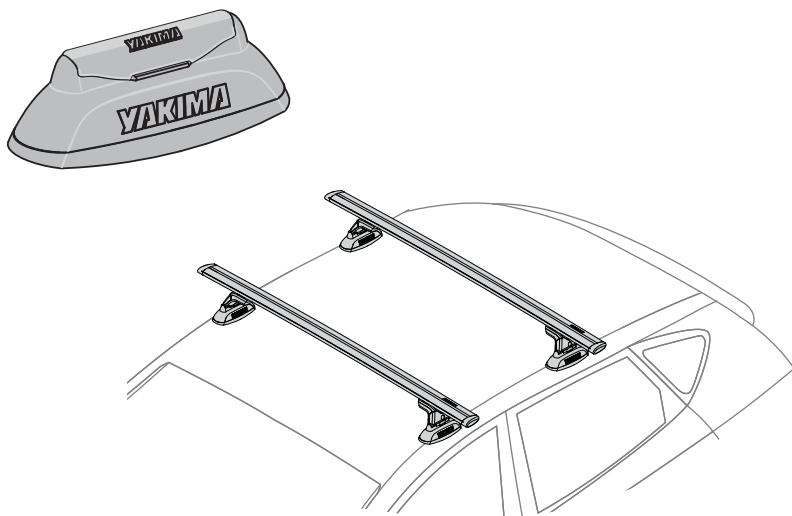

REMARQUE : LA DISTANCE ENTRE LES BARRES TRANSVERSALES EST FIXE.

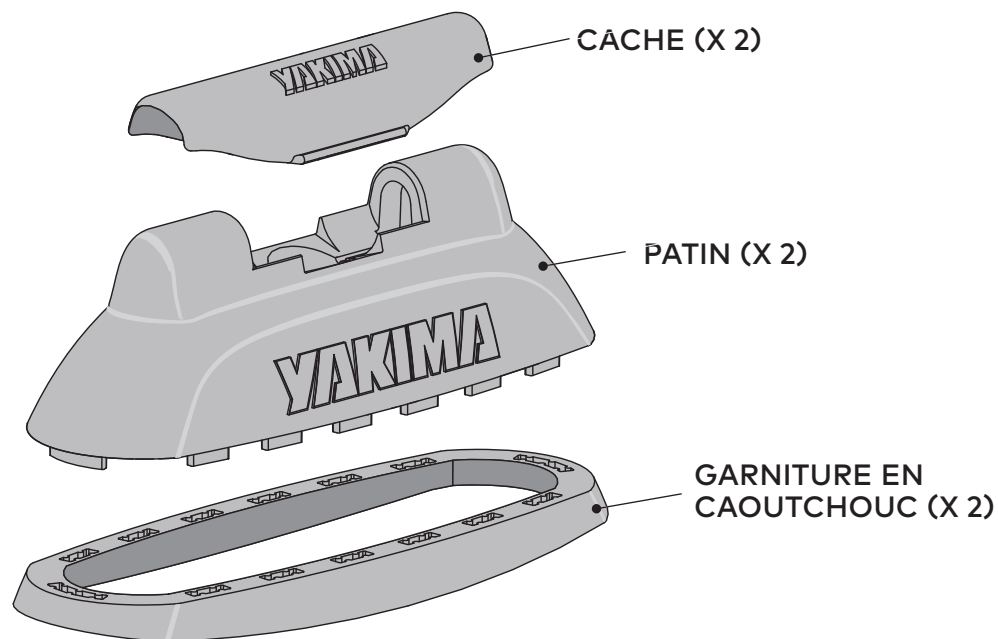

## OUTILS INCLUS

CLÉ ALLEN DE 5 MM



## SAC DE QUINCAILLERIE M7

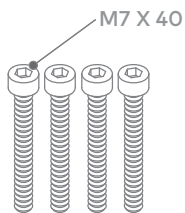

La trousse de quincaillerie M7X40 (article n° 8880281) n'est pas incluse avec le LandingPad 11. Pour la commander, appeler le service à la clientèle de Yakima au (888) 925-4621, du lundi au vendredi, entre 7 h et 17 h, heure du Pacifique. Prévoir de 3 à 5 jours ouvrables pour la livraison.

## SAC DE QUINCAILLERIE M6

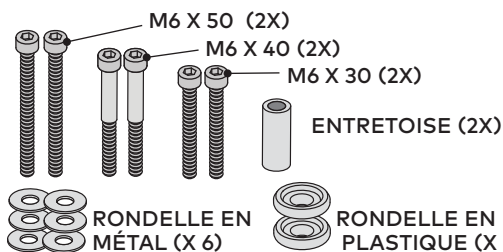

## SAC DE QUINCAILLERIE M8

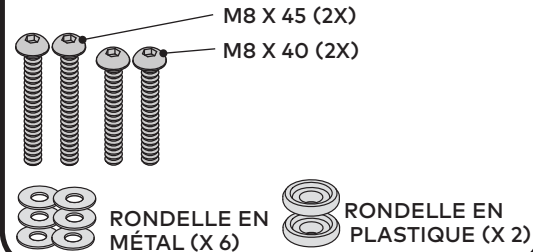

ON TROUVERA DANS LES INSTRUCTIONS ACCOMPAGNANT LES PIEDS CONTROL TOWER OU SKYLINE DE YAKIMA LES AVERTISSEMENTS IMPORTANTS ET LES LIMITES DE CHARGE, EN PLUS DE LA GARANTIE LIMITÉE YAKIMA.



**1**

**SI LE VÉHICULE EST ÉQUIPÉ DE BARRES TRANSVERSALES D'ORIGINE, LES ENLEVER ET PASSER À L'OPÉRATION 3.**

**2**

**OUVRIR LES CACHES**

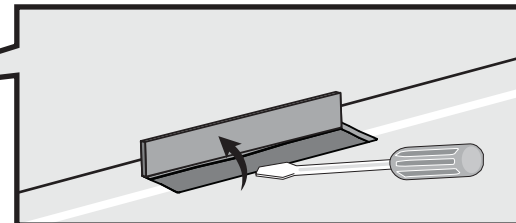
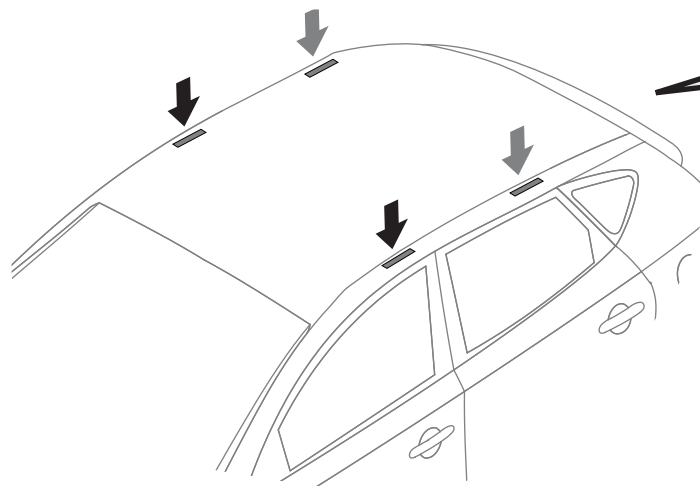

Consulter le manuel du véhicule pour déterminer comment on ouvre ou enlève les caches. Cela varie d'un véhicule à l'autre.

**3**

**DÉTERMINER QUELLE QUINCAILLERIE IL FAUT ET NETTOYER LES FILETS**



Consulter le tableau en page 10 (ou aller en ligne à [yakimatech.com](http://yakimatech.com) si le véhicule n'y figure pas) pour déterminer quelle quincaillerie il faut.

Vérifier qu'il ne reste pas de peinture dans les filets en y vissant soigneusement quelques fois un boulon et en soufflant les débris éventuels.

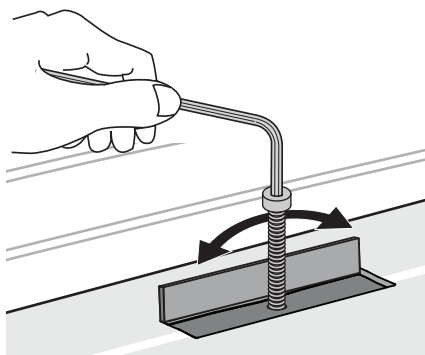

**REMARQUE :** s'il y a plusieurs trous par emplacement, employer ceux les plus en arrière.

**REMARQUE :** sur certains véhicules, un bouchon obture le trou : l'enlever.

**4**

**ENLEVER LES CACHES.**

Enlever le cache des patins.

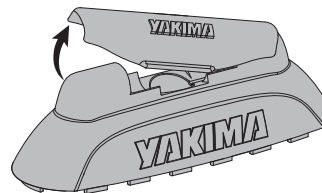

Les caches servent à fermer l'ouverture des patins quand les barres transversales ne sont pas en place.

**5**

**POSER LES GARNITURES SUR LES PATINS.**

Poser une garniture sous chaque patin.

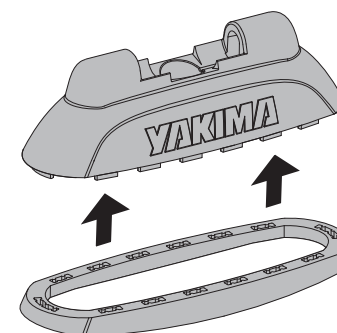

## 6 POSER LES PATINS LANDING PAD



Consulter le tableau en page 10 (ou aller en ligne à [yakimatech.com](http://yakimatech.com) si le véhicule n'y figure pas) pour déterminer quelle quincaillerie il faut.

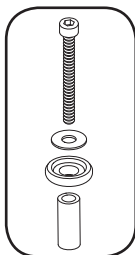

Employer l'entretoise M6 si le véhicule l'exige.

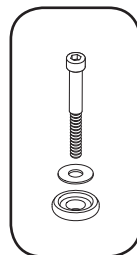

Quincaillerie M6

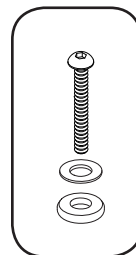

Quincaillerie M8



**S'ASSURER D'EMPLOYER LES BOULONS DE LA BONNE LONGUEUR !**

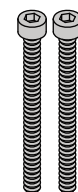

M6 X 50

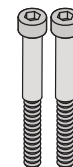

M6 X 40



M6 X 30

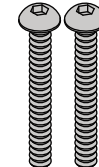

M8 X 45

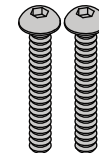

M8 X 40

- Le toit doit être propre et sec. Y déposer le patin.
- Déposer une rondelle en métal sur une rondelle en plastique, avec la face convexe de la rondelle en plastique vers le bas. Au besoin, ajouter des rondelles pour empêcher le boulon de toucher le fond du trou.
- Enfiler le boulon à travers les rondelles, à travers le patin et l'engager dans le trou fileté dans le toit.
- Faire tourner le boulon et le serrer avec la branche courte de la clé, tel qu'illustré, mais ne pas serrer complètement. FAIRE ATTENTION DE NE PAS DÉTÉRIORER LE FILETAGE.
- Bouger et tourner le patin dans tous les sens pour s'assurer que la rondelle de plastique est bien en place, ce qui laissera aussi au patin un petit jeu en vue de l'alignement et du serrage final que l'on fera à l'opération 7.
- Recommencer pour le deuxième patin.



**! ATTENTION : NE PAS LAISSER LES REBORDS DE LA GARNITURE SE RETOURNER PAR EN-DESSOUS !**

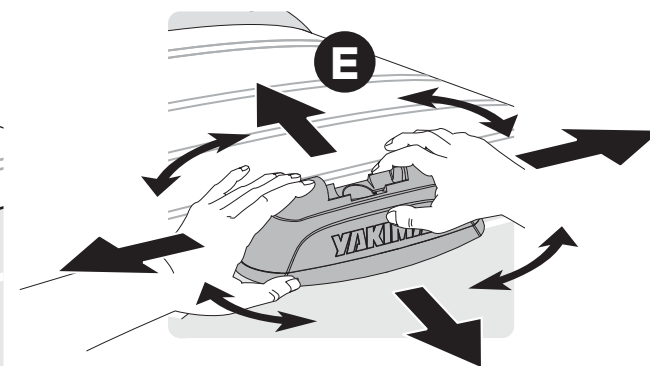
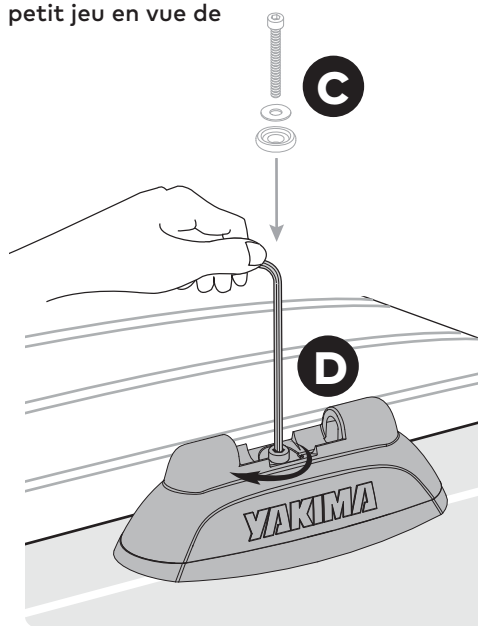
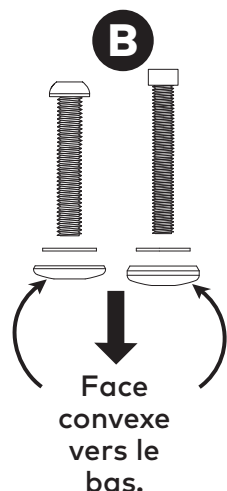
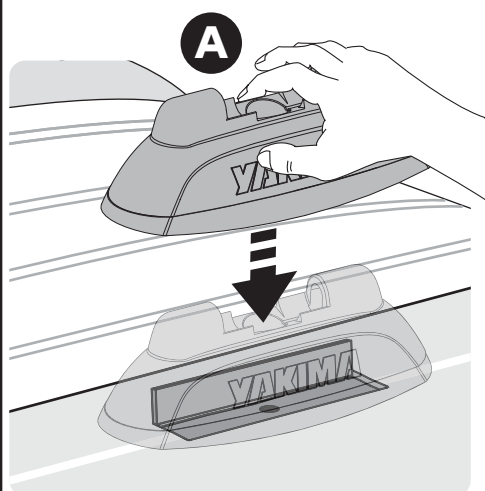
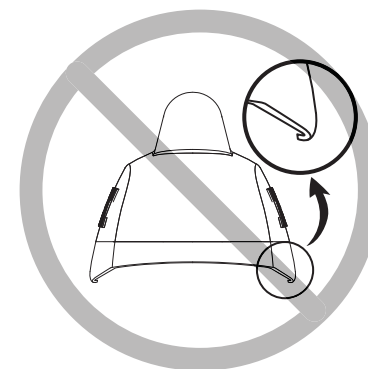

**REMARQUE : on effectuera le serrage final à l'opération suivante.**

## 7 RÉGLER LA POSITION DES PATINS ET LES SERRER.

- En suivant les instructions qui accompagnent les pieds, déposer soigneusement une barre munie de ses pieds sur les patins.
- Ajuster la position des patins Landing Pad pour que l'on puisse fermer complètement les pieds SkyLine ou Control Tower.
- Centrer les barres transversales et les serrer dans les pieds SkyLine ou Control Tower en suivant les instructions qui accompagnent les pieds.

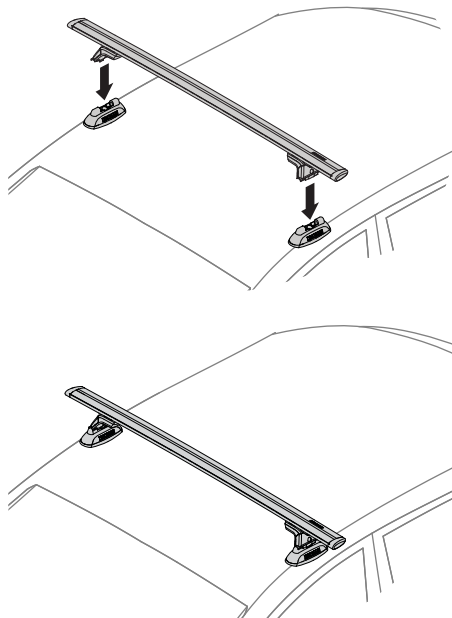

- Ouvrir le capot d'un pied SkyLine ou Control Tower et le soulever tandis que l'autre pied est toujours accroché.
- Tout en tenant le pied SkyLine ou Control Tower au-dessus du patin, serrer complètement le boulon du patin à 1.5 Nm (13.3 in lb) (employer le côté long de la clé, tel qu'illustré). NE PAS TROP SERRER, CAR ON RISQUERAIT D'ENDOMMAGER LE TOIT.
- Répéter l'opération pour les autres patins Landing Pad en faisant en sorte qu'ils n'aient pas bougé.
- Réengager le pied SkyLine ou Control Tower dans le patin, serrer le pied complètement (suivre les instructions qui accompagnent les pieds) et rabattre le capot.

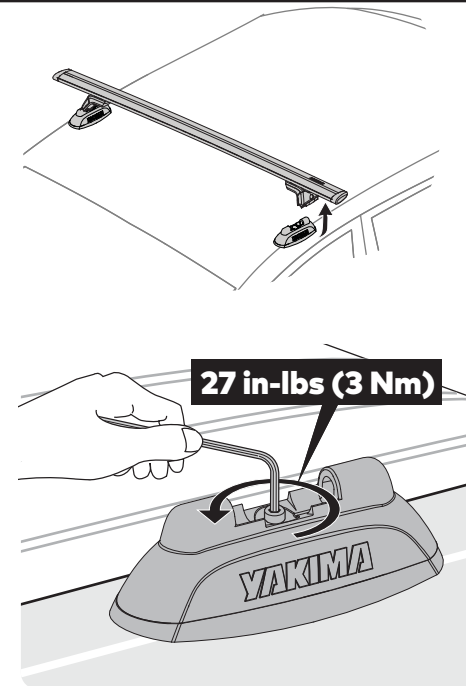

**REMARQUE :** à cause de variantes de fabrication, il est possible que le boulon touche le fond du trou avant que le patin ne soit complètement serré. Si cela arrive, revenir à l'opération 6 en ajoutant d'autres rondelles de métal pour rattraper le jeu.

## 8 LIRE CES AVERTISSEMENTS !



S'assurer que les pieds SkyLine ou Control Tower, avec les barres en place, sont complètement engagés dans les patins Landing Pad. S'ils ne s'engagent pas complètement, répéter l'opération 6.



S'assurer que le montage est solide et conforme aux instructions. Si l'on n'effectue pas les vérifications de sécurité avant de prendre la route, on risque de provoquer des dommages, des blessures ou même la mort.

Les dispositifs de fixation peuvent se desserrer à la longue. Les inspecter avant chaque utilisation et les resserrer au besoin.

Pour prévenir les dommages au fini du véhicule, démonter périodiquement les patins Landing Pad et les nettoyer ainsi que leurs points de montage car des sédiments s'y accumuleront à la longue.



### NE PAS DÉPASSER LA LIMITE DE CHARGE DU VÉHICULE.

Pour connaître la limite de chargement spécifique du véhicule et les limites de poids admissibles sur les accessoires, consulter le site [yakimatech.com](http://yakimatech.com).

Pour obtenir plus de renseignements sur ce produit prière de consulter le site [yakima.com/support](http://yakima.com/support) ou de nous appeler directement au (888) 925-4621, du lundi au vendredi, entre 7 heures et 17 heures, heure du Pacifique.

**Enlever le porte-bagages et les accessoires YAKIMA avant de passer dans un lave-auto automatique.**

## 9 POURSUIVRE LA POSE DES PIEDS CONTROL TOWER OU SKYLINE.



# LANDING PAD 11 FIT NOTES

Consulter  
les remarque  
s'appliquant  
au véhicule.  
(Pages 25-33)



	BOULON / LONGUEUR	NBRE RONDELLES AV.	NBRE RONDELLES AR.	EMPLOYER ENTRETOISE M6	POIDS MAXI.	
<b>BMW</b>						
1 Series 2dr	08-13	M6x40	1	1	165 lbs./75 kg	1,2,5,14,47,54,64,81,82,109,110,187,191,197,601
2 Series 2dr	14-19	M6x40	1	1	165 lbs./75 kg	1,2,5,14,40,45,47,81,82,109,110,143,187,191,601
3 Series 2dr	00-06	M6x40	1	1	165 lbs./75 kg	1,2,5,14,47,54,64,81,82,100,109,110,187,191,197,601
3 Series 4dr	06-11	M6x40	1	1	165 lbs./75 kg	1,2,5,14,40,45,47,81,82,109,110,143,187,191,601
3 Series 4dr	12-18	M6x40	1	1	165 lbs./75 kg	1,2,5,14,40,45,47,81,82,109,110,143,187,191,601
3 Series 4dr	99-05	M6x40	1	1	165 lbs./75 kg	1,2,5,14,47,54,64,81,82,100,109,110,187,191,197
3 Series Wagon	11-12	M6x40	1	1	165 lbs./75 kg	1,2,5,14,40,45,47,54,69,81,82,100,109,110,132,143,187,191,197,601
3 Series Gran Turismo 5dr	14-19	M6x40	1	1	165 lbs./75 kg	1,2,5,14,40,45,47,81,82,109,110,132,143,187,191,601
4 Series 2dr	14-19	M6x40	1	1	100 lbs./45 kg	1,2,5,14,40,45,47,81,82,109,110,143,187,191,601
4 Series Gran Coupe 4dr	15-19	M6x40	1	1	165 lbs./75 kg	1,2,5,14,40,45,47,81,82,100,109,110,143,187,191,197,601
5 Series 4dr	97-03	M6x40	1	1	165 lbs./75 kg	1,2,5,14,47,54,64,81,82,109,110,187,191,197,601
5 Series 4dr	11-16	M7x40	3	3	165 lbs./75 kg	2,5,14,39,54,64,81,82,109,110,191,197,601
5 Series Gran Turismo 5dr	10-19	M6x40	1	1	165 lbs./75 kg	1,2,5,14,47,61,64,69,81,82,109,110,132,187,191,197,601
<b>CHEVROLET</b>						
City Express 5dr	15-18	M8x40	1	1	165 lbs./75 kg	2,5,14,18,49,51,64,81,84,85,86,100,104,107,109,110,164,165,191,601
<b>FORD</b>						
Flex 5dr	09-19	M6x50	1	1	165 lbs./75 kg	04,107,109,110,164,165,191,601
Transit Connect 5dr	10-13	M8x40	1	1	165 lbs./75 kg	2,5,14,18,49,64,81,84,85,86,109,110,164,165,191,194,601
<b>HYUNDAI</b>						
Accent 5dr	12-17	M6x40	1	1	165 lbs./75 kg	2,5,14,47,64,69,81,82,107,109,110,132,164,191,197,601
Elantra GT 5dr	13-17	M6x50	4	4	150lbs./68 kg	2,5,14,41,48,54,64,69,81,82,109,113,132,187,191,197,601
i-25 5dr	12-13	M6x40	1	1	165 lbs./75 kg	2,5,14,46,64,81,82,107,109,110,164,191,601
<b>KIA</b>						
Soul 5dr	14-19	M6x50	1	1	165 lbs./75 kg	1,2,5,14,48,64,69,81,82,109,113,132,187,191,197,601
<b>LAND ROVER</b>						
LR4 5dr	10-16	M6x40	1	1	165 lbs./75 kg	2,5,14,47,51,64,69,81,82,100,104,109,110,132,164,165,191,601
Range Rover 5dr	03-12	M8x45	1	1	165 lbs./75 kg	2,5,14,50,51,64,81,82,100,104,109,110,140,187,191,197,601



# LANDING PAD 11 FIT NOTES

Consulter  
les remarque  
s'appliquant  
au véhicule.  
(Pages 25-33)



**BOULON / LONGUEUR**

**NBRE  
RONDELLES  
AV.**

**NBRE  
RONDELLES  
AR.**

**EMPLOYER  
ENTRETOISE  
M6**

**POIDS MAXI.**





MAZDA							
2 5dr	11-15	M6x40	3	3		165 lbs./75 kg	1,2,5,14,47,64,81,82,109,110,132,187,191,197,601
3 4dr	04-09	M6x40	1	2		165 lbs./75 kg	1,2,5,14,47,52,54,64,81,82,109,110,187,191,197,601
3 4dr	10-13	M6x40	1	1		165 lbs./75 kg	1,2,5,14,47,52,54,64,81,82,109,110,187,191,601
3 4dr	14-18	M6x40	1	1		165 lbs./75 kg	1,2,5,14,47,52,54,64,81,82,100,109,110,187,191,197,601
3 5dr	04-09	M6x40	1	1		165 lbs./75 kg	1,2,5,14,47,52,54,64,69,81,82,109,110,132,187,191,197,601
3 5dr	10-13	M6x40	1	1		165 lbs./75 kg	1,2,5,14,47,52,54,64,69,81,82,109,110,132,187,191,601
3 5dr	14-18	M6x40	1	1		165 lbs./75 kg	1,2,5,14,47,52,54,64,69,81,82,100,109,110,132,187,191,197,601
3 5dr	16-17	M6x30	1	1		165 lbs./75 kg	2,5,14,46,54,64,69,81,82,100,109,110,132,191
5 5dr	06-10	M6x30	1	1		165 lbs./75 kg	2,5,14,46,64,69,81,82,100,109,110,132,144,164,191,197
5 5dr	12-15	M6x30	1	1		165 lbs./75 kg	2,5,14,46,54,64,69,81,82,100,109,110,132,191
6 4dr	14-18	M6x40	1	1		165 lbs./75 kg	1,2,5,14,47,52,64,81,82,98,100,109,110,187,191,601
CX-3 5dr	16-19	M6x40	1	1		165 lbs./75 kg	1,2,5,14,47,52,54,64,69,81,82,100,109,110,132,187,191,601
CX-5 5dr	13-16	M6x30	1	1		165 lbs./75 kg	2,5,14,18,47,54,64,69,81,84,85,88,100,109,110,140,164,165,191,197,601
CX-7 5dr	07-12	M6x40	1	1		126 lbs./57 kg	1,2,5,14,47,54,61,69,81,109,113,140,187,191,197,601
CX-9 5dr	07-15	M6x40	2	2		165 lbs./75 kg	2,5,14,18,47,51,54,64,69,81,84,88,100,104,109,110,140,164,165,191,197,601
Protegé 5 5dr	02-03	M6x40	1	1		165 lbs./75 kg	1,2,5,14,47,64,69,81,82,100,109,110,132,144,187,191,197,601
Speed3 5dr	04-09	M6x40	1	1		165 lbs./75 kg	1,2,5,14,47,52,54,64,69,81,82,109,110,132,187,191,197,601
Speed3 5dr	10-13	M6x40	1	1		165 lbs./75 kg	1,2,5,14,47,52,54,64,69,81,82,109,110,132,187,191,197,601
MERCEDES							
B-Class 5dr	05-11	M6x40	1	1		165 lbs./75 kg	2,5,14,47,64,69,81,82,109,110,132,144,191,197,601
C-Class 2dr	12-15	M8x40	1	1		165 lbs./75 kg	2,5,14,49,54,64,81,82,109,110,187,191,197,601
C-Class 4dr	08-14	M8x40	1	1		165 lbs./75 kg	2,5,14,49,54,64,81,82,109,110,187,191,197,601
C-Class 4dr	15-19	M8x40	1	1		165 lbs./75 kg	2,5,14,49,64,81,82,100,109,113,143,187,191,601
CLS-Class 4dr	06-11	M8x40	2	1		165 lbs./75 kg	1,2,5,14,49,54,64,81,82,100,109,110,187,191,197,601
CLS-Class 4dr	12-18	M8x40	2	1		165 lbs./75 kg	1,2,5,14,49,54,64,81,82,109,110,187,191,197,601
E-Class 2dr	10-17	M8x40	1	1		165 lbs./75 kg	2,5,14,49,64,81,82,109,110,187,191,197,601
E-Class 4dr	03-09	M6x40	1	1		165 lbs./75 kg	2,5,14,47,54,64,81,82,109,110,187,191,197,601
E-Class 4dr	10-16	M8x40	1	1		165 lbs./75 kg	2,5,14,49,64,81,82,109,110,187,191,197,601
E-Class 4dr	17-18	M8x45	2	2		165 lbs./75 kg	2,5,14,50,54,64,81,82,100,109,110,191,601
GLC Coupe 5dr	17-18	M8x40	1	2		165 lbs./75 kg	2,5,14,49,54,64,69,81,82,100,109,110,132,187,191
R-Class 5dr	06-12	M8x40	1	1		165 lbs./75 kg	2,5,14,49,54,64,81,82,109,110,140,187,191,197,601



# LANDING PAD 11 FIT NOTES

Consulter  
les remarque  
s'appliquant  
au véhicule.  
(Pages 25-33)

		<b>BOULON / LONGUEUR</b>	<b>NBRE RONDELLES AV.</b>	<b>NBRE RONDELLES AR.</b>	<b>EMPLOYER ENTRETOISE M6</b>	<b>POIDS MAXI.</b>	
<b>MERCEDES</b>							
S-Class 4dr	07-13	M6x40	1	1		165 lbs./75 kg	2,5,14,49,54,64,81,82,100,109,110,187,191,197,601
<b>MITSUBISHI</b>							
Lancer Sportback 5dr	10-14	M6x40	1	1		165 lbs./75 kg	1,2,5,14,47,64,69,81,82,109,110,132,144,187,191,197,601
Outlander 5dr	10-13	M6x40	1	1		165 lbs./75 kg	1,2,5,14,47,54,64,69,81,82,100,109,110,132,187,191,197,601
Outlander 5dr	16-19	M6x40	1	1		165 lbs./75 kg	1,2,5,14,47,64,69,81,82,109,110,132,187,191,601
Outlander Sport 5dr	11-15	M6x40	1	1		165 lbs./75 kg	1,2,5,14,47,54,64,69,81,82,100,109,110,132,187,191,197,601
Outlander Sport 5dr	16-19	M6x40	1	1		165 lbs./75 kg	1,2,5,14,47,64,69,81,82,100,109,110,132,187,191,601
RVR 5dr	10-13	M6x40	1	1		165 lbs./75 kg	1,2,5,14,47,54,64,69,81,82,109,110,132,187,191,197,601
<b>NISSAN</b>							
NV200 5dr	13-19	M8x40	1	1		165 lbs./75 kg	2,5,14,18,49,51,64,81,84,85,86,100,104,109,110,164,165,191,197,601
<b>PORSCHE</b>							
911 2dr	05-12	M6x50	1	1		165 lbs./75 kg	2,14,48,54,64,81,82,100,110,187,601
Cayman 3dr	07-12	M6x50	1	1		125lbs./57 kg	2,14,48,54,64,81,82,110,187,601
Panamera 5dr	10-16	M6x50	1	1		165 lbs./75 kg	2,5,14,48,54,64,69,81,82,109,110,132,191,194,197,601
<b>RAM</b>							
Promaster City Dual sliding drs	15-19	M6x40	1	1		165 lbs./75 kg	2,5,14,47,64,81,82,98,100,104,109,110,132,191,601
<b>SAAB</b>							
9-3 Wagon	06-12	M6x50	1	1		165 lbs./75 kg	1,2,5,14,48,54,64,69,81,82,100,109,110,140,187,191,197,601
<b>SATURN</b>							
Astra 3dr	08-09	M6x40	1	1		165 lbs./75 kg	1,2,5,14,47,54,64,69,81,82,100,109,110,140,187,191,197,601
Astra 5dr	08-09	M6x40	1	1		165 lbs./75 kg	1,2,5,14,47,54,64,69,81,82,100,109,110,140,187,191,197,601
<b>SUBARU</b>							
Forester 5dr	11-11	M6x40	1	1		165 lbs./75 kg	1,2,5,14,47,54,64,69,81,82,109,110,132,187,191,197,601
Forester 5dr	09-13	M6x40	1	1		165 lbs./75 kg	1,2,5,14,47,54,64,69,81,82,100,109,110,132,187,191,197
Forester 5dr	14-18	M6x40	1	1		165 lbs./75 kg	2,5,14,47,54,64,69,81,82,109,110,132,164,191,197,601
Impreza 4dr	08-11	M6x40	1	1		165 lbs./75 kg	2,5,14,47,54,64,81,82,100,109,110,187,191,197
Impreza 4dr	17-19	M6x40	1	1		165 lbs./75 kg	2,5,14,47,54,64,81,82,100,104,109,110,191,601
Impreza 5dr	12-16	M6x40	1	1		165 lbs./75 kg	2,5,14,47,54,64,69,81,82,100,109,110,140,187,191,197,601



# LANDING PAD 11 FIT NOTES

Consulter  
les remarque  
s'appliquant  
au véhicule.  
(Pages 25-33)



		BOULON / LONGUEUR	NBRE RONDELLES AV.	NBRE RONDELLES AR.	EMPLOYER ENTRETOISE M6	POIDS MAXI.	
<b>SUBARU</b>							
Impreza 5dr	08-11	M6x40	1	1		165 lbs./75 kg	2,5,14,47,54,64,69,81,82,109,110,140,187,191,197
Impreza 5dr	17-19	M6x40	1	1		165 lbs./75 kg	2,5,14,47,54,64,81,82,100,109,110,132,187,191,601
Impreza WRX/STI 4dr	08-11	M6x40	1	1		165 lbs./75 kg	2,5,14,47,54,64,81,82,109,110,187,191,197,601
Impreza WRX/STI 5dr	08-14	M6x40	1	1		165 lbs./75 kg	2,5,14,47,54,64,81,82,100,109,110,187,191,197,601
Impreza WRX/STI 5dr	08-14	M6x40	1	1		165 lbs./75 kg	2,5,14,47,54,64,69,81,82,100,109,110,140,187,191,197,601
Outback Sport 5dr	08-11	M6x40	1	1		165 lbs./75 kg	2,5,14,47,54,64,69,81,82,100,109,110,140,187,191,197
Tribeca 5dr	06-07	M6x40	1	1		165 lbs./75 kg	2,5,14,18,47,54,64,69,81,84,85,86,100,109,110,140,164,165,191,197,601
Tribeca 5dr	08-14	M6x40	1	1		165 lbs./75 kg	2,5,14,18,47,54,64,69,81,84,85,86,100,109,110,140,164,165,191,197,601
WRX/STI 4dr	18-19	M6x40	1	1		165 lbs./75 kg	2,5,11,14,47,64,81,82,104,109,110,132,187,191
<b>SUZUKI</b>							
Kizashi 4dr	10-13	M6x40	1	1		165 lbs./75 kg	2,5,14,47,64,81,82,100,109,110,164,191,197,601
<b>TESLA</b>							
Model S w/ Panoramic Roof 4dr	12-14	M8x40	1	1		165 lbs./75 kg	2,5,14,49,64,81,82,107,109,112,132,164,191,197,601
Model S w/ Panoramic Roof 4dr	15-18	M6x40	1	1		165 lbs./75 kg	2,5,14,47,64,81,82,107,109,112,132,162,164,191,197,601
<b>VOLVO</b>							
V40 5dr	99-04	M6x30	1	1		165 lbs./75 kg	2,5,14,46,54,64,69,81,82,100,104,109,110,132,191,601



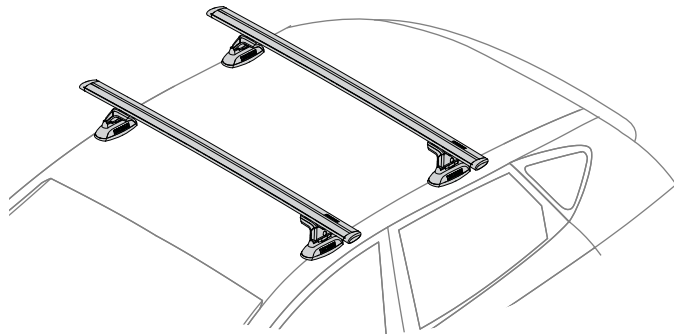

NOTA: LA SEPARACIÓN ENTRE LAS BARRAS TRANSVERSALES ES FIJA.

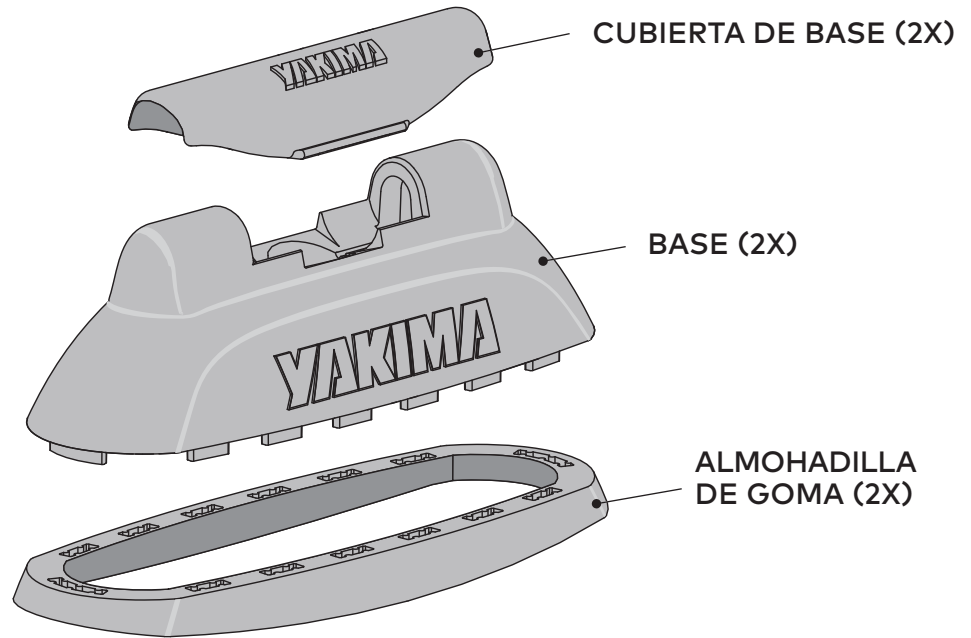

## HERRAMIENTAS INCLUIDAS

LLAVE ALLEN DE 5 MM



## BOLSA DE MATERIAL M7

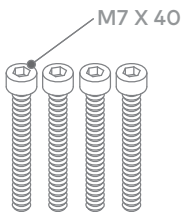

Las piezas M7X40 (PN 8880281) no vienen incluidas en el Landing Pad 11. Para encargar esas piezas, póngase en contacto con el Servicio a la clientela de Yakima llamando al (888) 925-4621, de lunes a viernes, de 7:00 a 5:00 P.M., hora del Pacífico. Por favor prevea de 3 a 5 días hábiles para la entrega.

## BOLSA DE MATERIAL M6

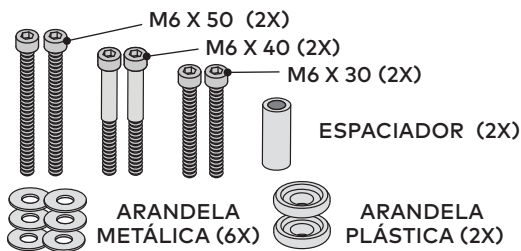

## BOLSA DE MATERIAL M8

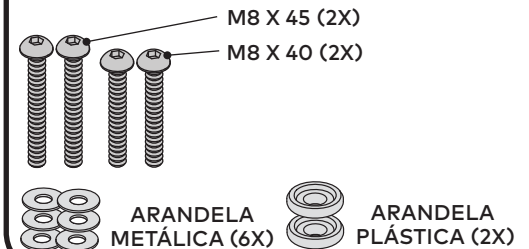

**CONSULTE LAS INSTRUCCIONES DE LAS TORRES SKYLINE O CONTROL TOWER DE YAKIMA PARA CONOCER LAS ADVERTENCIAS IMPORTANTES, LOS LÍMITES DE CARGA Y LA GARANTÍA LIMITADA DE YAKIMA.**



**1**

**SI SU VEHÍCULO TIENE BARRAS TRANSVERSALES DE FÁBRICA, RETÍRELAS AHORA Y LUEGO PASE A LA ETAPA 3.**

**2**

**ABRA LAS TAPAJUNTAS.**

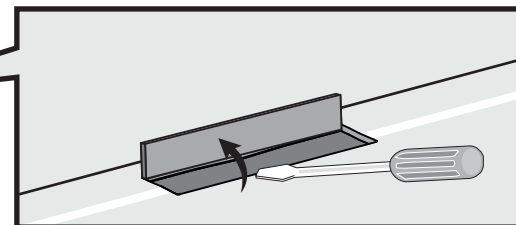
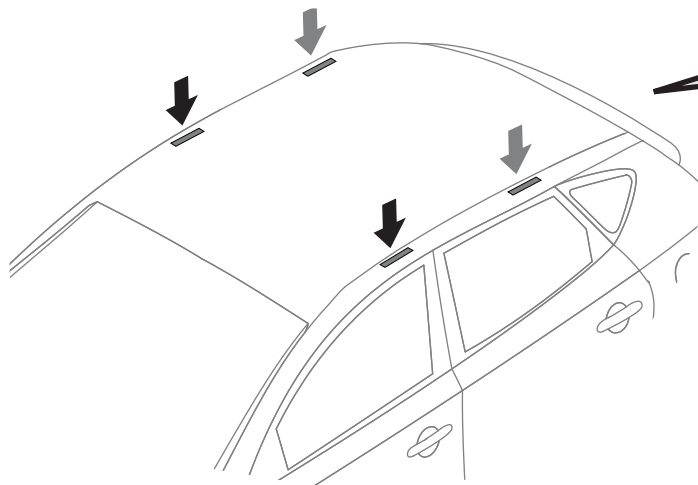

Consulte el manual del usuario de su vehículo para saber cómo se abren o se quitan las tapajuntas. Esto varía de un vehículo a otro.

**3**

**DETERMINE EL MATERIAL QUE CORRESPONDE A SU VEHÍCULO Y PREPARE LOS FILETES DE ROSCA.**

 Consulte la lista de compatibilidad de la página 15 (o en línea visitando [yakimatech.com](http://yakimatech.com), si su vehículo no está listado) para determinar el material que corresponde a su vehículo.

Asegúrese de que los filetes de rosca están libres de pintura. Para esto, enrosque y desenrosque el sujetador cuidadosamente varias veces y cada vez que lo saca sople lo más lejos posible todo residuo que pueda estar acumulado.

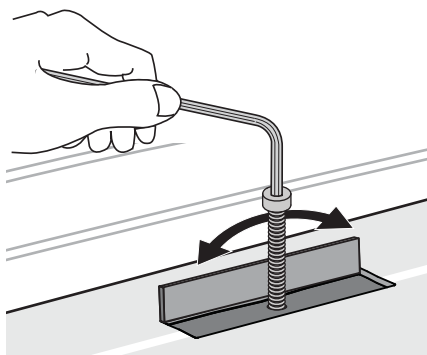

**NOTA:** Si en cada cavidad hay varios agujeros, utilice aquéllos que están más atrás.

**NOTA:** Algunos vehículos vienen con un tapón para proteger la rosca. Estos tapones se deben retirar.

**4**

**RETIRE LAS CUBIERTAS.**

Retire las cubiertas de las bases.

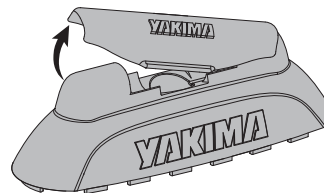

Cuando las barras no están instaladas, utilice las cubiertas para mantener las bases libres de residuos.

**5**

**INSTALE LAS ALMOHADILLAS EN LAS BASES.**

Una cada almohadilla a su base.

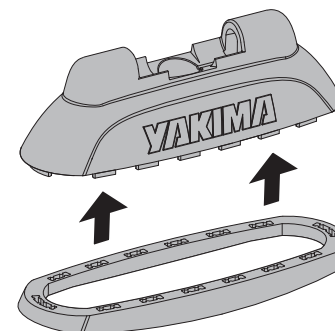

## 6 FIJE LAS LANDING PADS.



Consulte la lista de compatibilidad de la página 15 (o en línea visitando [yakimatech.com](http://yakimatech.com), si su vehículo no está listado) para determinar el material que corresponde a su vehículo.

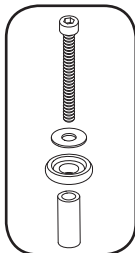

UTILICE EL ESPACIADOR M6 SI SU VEHÍCULO LO REQUIERE.

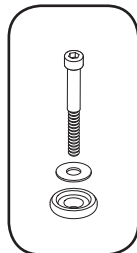

MATERIAL M6

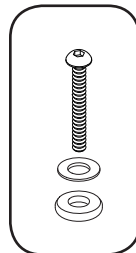

MATERIAL M8



¡ASEGÚRESE DE UTILIZAR EL MATERIAL CON EL LARGO CORRECTO!

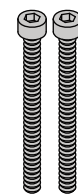

M6 X 50



M6 X 40



M6 X 30

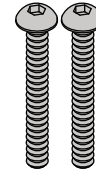

M8 X 45

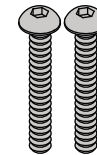

M8 X 40

- A) Ubique el Landing Pad en su lugar sobre el techo. Éste debe estar limpio y seco.
- B) Coloque la arandela metálica encima de la arandela plástica, con la parte convexa de esta última hacia abajo. Cuando sea necesario, agregue arandelas para evitar que el tornillo toque el techo.
- C) Pase el sujetador a través de las arandelas y del Landing Pad y enrósquelo en el punto de fijación elegido del techo.
- D) Termine de enroscar el sujetador y apriételo con la parte corta de la llave, como se muestra, pero sin apretarlo completamente. TENGA CUIDADO DE QUE EL SUJETADOR NO ENTRE CRUZADO EN LA ROSCA.
- E) Empuje y gire el Landing Pad en todas las direcciones para asegurar que la arandela plástica queda completamente asentada. Al mismo tiempo, deje que el Landing Pad tenga un cierto juego para prever la alineación y el apretado final en el paso 7.
- F) Repita la operación para el segundo Landing Pad.



¡ADVERTENCIA: EVITE QUE LOS BORDES DE LA ALMOHADILLA QUEDEN CON PLIEGUES!

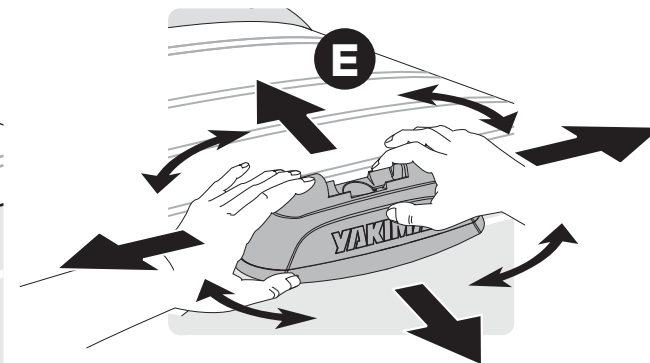
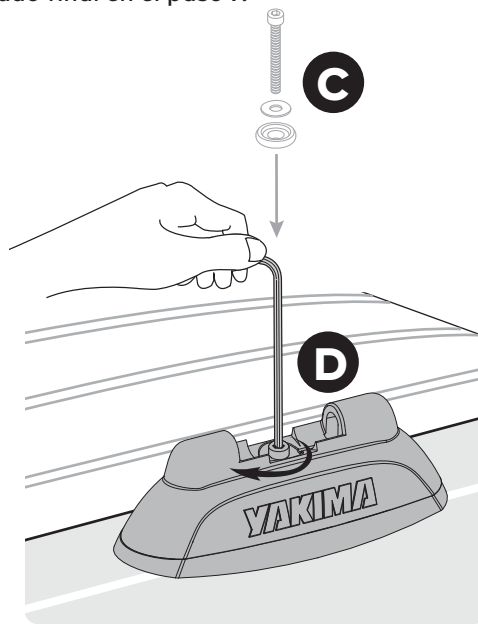
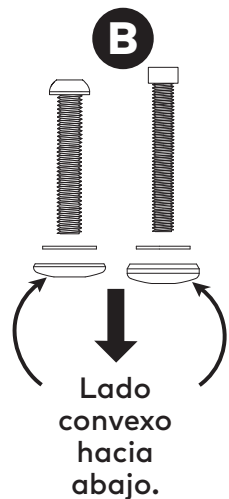
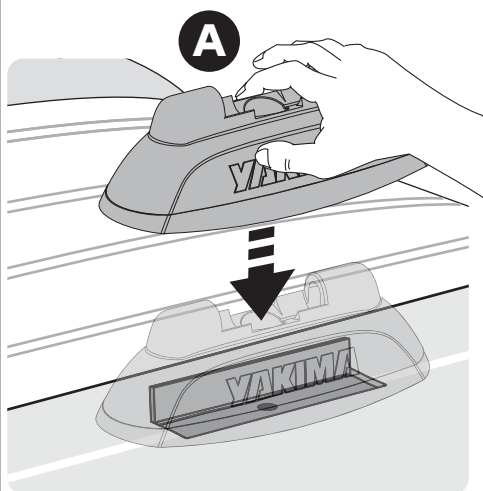
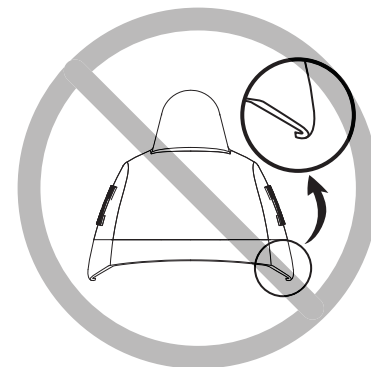

NOTA: El ajuste final se hará en el paso siguiente.

## 7 AJUSTE LAS POSICIONES DE LOS LANDING PADS Y DESPUÉS APRIÉTELOS.

- Utilice las instrucciones de las torres como referencia, para colocar cuidadosamente una barra transversal armada con las torres sobre las Landing Pads.
- Alinee la posición de las Landing Pads para permitir que las torres SkyLine o Control Towers queden correctamente posicionadas.
- Centre las barras transversales y fije las torres a dichas barras siguiendo las instrucciones que vienen con las torres SkyLine o Control Towers.
- Abra una tapa de una torre SkyLine o Control Tower y manténgala levantada mientras la torre opuesta sigue enganchada.

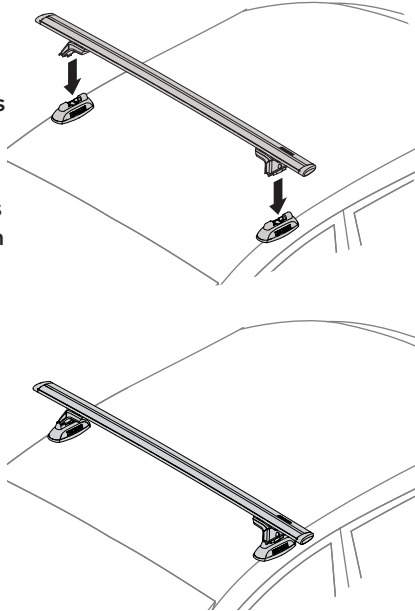

- Mientras sostiene la torre SkyLine o Control Tower sobre la Landing Pad, apriete completamente la Landing Pad con una fuerza de 3Nm (27 in-lb) (utilice el extremo más largo de la llave, como se ilustra). **NO APRIETE EXCESIVAMENTE PORQUE PUEDE DAÑAR EL TECHO.**
- Repita el proceso nuevamente con las otras Landing Pad, asegurándose de que no hayan cambiado de posición.
- Vuelva a introducir las torres SkyLine o Control Tower en la Landing Pad, apriete completamente la torre y cierre la tapa (consulte las instrucciones de las torres).

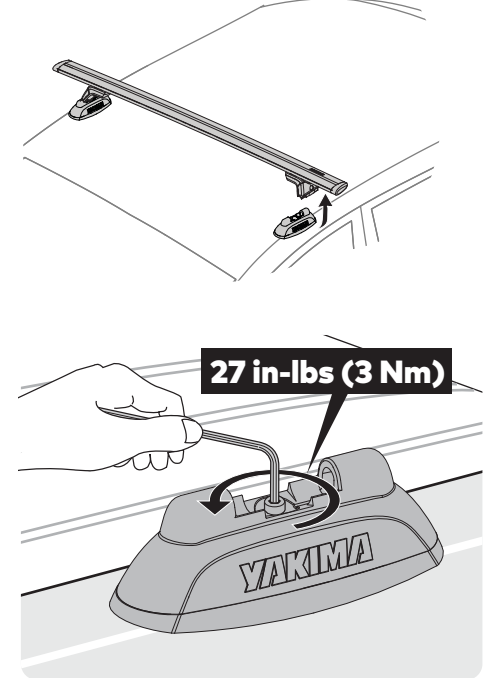

**NOTA:** Debido a las variaciones de fabricación, es posible que el tornillo de fijación toque el fondo del agujero antes de que la almohadilla quede completamente apretada. En ese caso, vuelva al paso 6 y agregue arandelas de metal adicionales (hasta 3) para alejar el extremo del tornillo del fondo del agujero.

## 8 ¡LEA ESTAS ADVERTENCIAS!



Cerciórese de que las torres SkyLine o Control Towers, con las barras instaladas, queden bien asentadas sobre las Landing Pad. De lo contrario, repita el paso 6.



Cerciórese de que todas las piezas de fijación estén aseguradas según las instrucciones. Si no se realizan las verificaciones de seguridad antes de partir, se pueden provocar daños materiales, heridas corporales o la muerte.

Las piezas de fijación se pueden aflojar después de un cierto tiempo. Verifique antes de cada uso y, si es necesario, apriételas.

Para evitar que el acabado de su vehículo resulte dañado, retire y limpie periódicamente las Landing Pad y los puntos de montaje ya que se pueden acumular partículas de la ruta después de un cierto tiempo.



### NO EXCEDA EL LÍMITE MÁXIMO DE PESO PARA SU VEHÍCULO.

Para verificar los límites de peso y de carga específicos de los accesorios para su vehículo, visite [yakimatech.com](http://yakimatech.com).

Para solicitar ayuda adicional sobre el producto, visite [yakima.com/support](http://yakima.com/support) o póngase en contacto directamente con nosotros llamando al (888)925-4621, de lunes a viernes, de 7:00 a 5:00 P.M., hora del Pacífico.

**Retire el portaequipajes y accesorios YAKIMA antes de entrar en un lavadero automático de vehículos.**

## 9 CONTINÚE CON LA INSTALACIÓN DE LAS TORRES SKYLINE O CONTROL TOWER.



# LANDING PAD 11 FIT NOTES

Lea las notas  
que se aplican  
a su vehículo.  
(Páginas 25-33)



		MATERIAL/LARGO	CANT. ARANDELAS ADEL.	CANT. ARANDELAS ATRAS	ESPACIADOR M6 REQUERIDO	PESO MÁXIMO	
<b>BMW</b>							
1 Series 2dr	08-13	M6x40	1	1		165 lbs./75 kg	1,2,5,14,47,54,64,81,82,109,110,187,191,197,601
2 Series 2dr	14-19	M6x40	1	1	Yes	165 lbs./75 kg	1,2,5,14,40,45,47,81,82,109,110,143,187,191,601
3 Series 2dr	00-06	M6x40	1	1		165 lbs./75 kg	1,2,5,14,47,54,64,81,82,100,109,110,187,191,197,601
3 Series 4dr	06-11	M6x40	1	1	Yes	165 lbs./75 kg	1,2,5,14,40,45,47,81,82,109,110,143,187,191,601
3 Series 4dr	12-18	M6x40	1	1	Yes	165 lbs./75 kg	1,2,5,14,40,45,47,81,82,109,110,143,187,191,601
3 Series 4dr	99-05	M6x40	1	1		165 lbs./75 kg	1,2,5,14,47,54,64,81,82,100,109,110,187,191,197
3 Series Wagon	11-12	M6x40	1	1	Yes	165 lbs./75 kg	1,2,5,14,40,45,47,54,69,81,82,100,109,110,132,143,187,191,197,601
3 Series Gran Turismo 5dr	14-19	M6x40	1	1	Yes	165 lbs./75 kg	1,2,5,14,40,45,47,81,82,109,110,132,143,187,191,601
4 Series 2dr	14-19	M6x40	1	1	Yes	100 lbs./45 kg	1,2,5,14,40,45,47,81,82,109,110,143,187,191,601
4 Series Gran Coupe 4dr	15-19	M6x40	1	1	Yes	165 lbs./75 kg	1,2,5,14,40,45,47,81,82,100,109,110,143,187,191,197,601
5 Series 4dr	97-03	M6x40	1	1		165 lbs./75 kg	1,2,5,14,47,54,64,81,82,109,110,187,191,197,601
5 Series 4dr	11-16	M7x40	3	3		165 lbs./75 kg	2,5,14,39,54,64,81,82,109,110,191,197,601
5 Series Gran Turismo 5dr	10-19	M6x40	1	1		165 lbs./75 kg	1,2,5,14,47,61,64,69,81,82,109,110,132,187,191,197,601
<b>CHEVROLET</b>							
City Express 5dr	15-18	M8x40	1	1		165 lbs./75 kg	2,5,14,18,49,51,64,81,84,85,86,100,104,107,109,110,164,165,191,601
<b>FORD</b>							
Flex 5dr	09-19	M6x50	1	1		165 lbs./75 kg	04,107,109,110,164,165,191,601
Transit Connect 5dr	10-13	M8x40	1	1		165 lbs./75 kg	2,5,14,18,49,64,81,84,85,86,109,110,164,165,191,194,601
<b>HYUNDAI</b>							
Accent 5dr	12-17	M6x40	1	1		165 lbs./75 kg	2,5,14,47,64,69,81,82,107,109,110,132,164,191,197,601
Elantra GT 5dr	13-17	M6x50	4	4		150lbs./68 kg	2,5,14,41,48,54,64,69,81,82,109,113,132,187,191,197,601
i-25 5dr	12-13	M6x40	1	1		165 lbs./75 kg	2,5,14,46,64,81,82,107,109,110,164,191,601
<b>KIA</b>							
Soul 5dr	14-19	M6x50	1	1		165 lbs./75 kg	1,2,5,14,48,64,69,81,82,109,113,132,187,191,197,601
<b>LAND ROVER</b>							
LR4 5dr	10-16	M6x40	1	1		165 lbs./75 kg	2,5,14,47,51,64,69,81,82,100,104,109,110,132,164,165,191,601
Range Rover 5dr	03-12	M8x45	1	1		165 lbs./75 kg	2,5,14,50,51,64,81,82,100,104,109,110,140,187,191,197,601



# LANDING PAD 11 FIT NOTES

Lea las notas  
que se aplican  
a su vehículo.  
(Páginas 25-33)



		MATERIAL/LARGO	CANT. ARANDELAS ADEL.	CANT. ARANDELAS ATRAS	ESPACIADOR M6 REQUERIDO	PESO MÁXIMO	
<b>MAZDA</b>							
2 5dr	11-15	M6x40	3	3		165 lbs./75 kg	1,2,5,14,47,64,81,82,109,110,132,187,191,197,601
3 4dr	04-09	M6x40	1	2		165 lbs./75 kg	1,2,5,14,47,52,54,64,81,82,109,110,187,191,197,601
3 4dr	10-13	M6x40	1	1		165 lbs./75 kg	1,2,5,14,47,52,54,64,81,82,109,110,187,191,601
3 4dr	14-18	M6x40	1	1		165 lbs./75 kg	1,2,5,14,47,52,54,64,81,82,100,109,110,187,191,197,601
3 5dr	04-09	M6x40	1	1		165 lbs./75 kg	1,2,5,14,47,52,54,64,69,81,82,109,110,132,187,191,197,601
3 5dr	10-13	M6x40	1	1		165 lbs./75 kg	1,2,5,14,47,52,54,64,69,81,82,109,110,132,187,191,601
3 5dr	14-18	M6x40	1	1		165 lbs./75 kg	1,2,5,14,47,52,54,64,69,81,82,100,109,110,132,187,191,197,601
3 5dr	16-17	M6x30	1	1		165 lbs./75 kg	2,5,14,46,54,64,69,81,82,100,109,110,132,191
5 5dr	06-10	M6x30	1	1		165 lbs./75 kg	2,5,14,46,64,69,81,82,100,109,110,132,144,164,191,197
5 5dr	12-15	M6x30	1	1		165 lbs./75 kg	2,5,14,46,54,64,69,81,82,100,109,110,132,191
6 4dr	14-18	M6x40	1	1		165 lbs./75 kg	1,2,5,14,47,52,64,81,82,98,100,109,110,187,191,601
CX-3 5dr	16-19	M6x40	1	1		165 lbs./75 kg	1,2,5,14,47,52,54,64,69,81,82,100,109,110,132,187,191,601
CX-5 5dr	13-16	M6x30	1	1		165 lbs./75 kg	2,5,14,18,47,54,64,69,81,84,85,88,100,109,110,140,164,165,191,197,601
CX-7 5dr	07-12	M6x40	1	1		126 lbs./57 kg	1,2,5,14,47,54,61,69,81,109,113,140,187,191,197,601
CX-9 5dr	07-15	M6x40	2	2		165 lbs./75 kg	2,5,14,18,47,51,54,64,69,81,84,88,100,104,109,110,140,164,165,191,197,601
Protegé 5 5dr	02-03	M6x40	1	1		165 lbs./75 kg	1,2,5,14,47,64,69,81,82,100,109,110,132,144,187,191,197,601
Speed3 5dr	04-09	M6x40	1	1		165 lbs./75 kg	1,2,5,14,47,52,54,64,69,81,82,109,110,132,187,191,197,601
Speed3 5dr	10-13	M6x40	1	1		165 lbs./75 kg	1,2,5,14,47,52,54,64,69,81,82,109,110,132,187,191,197,601
<b>MERCEDES</b>							
B-Class 5dr	05-11	M6x40	1	1		165 lbs./75 kg	2,5,14,47,64,69,81,82,109,110,132,144,191,197,601
C-Class 2dr	12-15	M8x40	1	1		165 lbs./75 kg	2,5,14,49,54,64,81,82,109,110,187,191,197,601
C-Class 4dr	08-14	M8x40	1	1		165 lbs./75 kg	2,5,14,49,54,64,81,82,109,110,187,191,197,601
C-Class 4dr	15-19	M8x40	1	1		165 lbs./75 kg	2,5,14,49,64,81,82,100,109,113,143,187,191,601
CLS-Class 4dr	06-11	M8x40	2	1		165 lbs./75 kg	1,2,5,14,49,54,64,81,82,100,109,110,187,191,197,601
CLS-Class 4dr	12-18	M8x40	2	1		165 lbs./75 kg	1,2,5,14,49,54,64,81,82,109,110,187,191,197,601
E-Class 2dr	10-17	M8x40	1	1		165 lbs./75 kg	2,5,14,49,64,81,82,109,110,187,191,197,601
E-Class 4dr	03-09	M6x40	1	1		165 lbs./75 kg	2,5,14,47,54,64,81,82,109,110,187,191,197,601
E-Class 4dr	10-16	M8x40	1	1		165 lbs./75 kg	2,5,14,49,64,81,82,109,110,187,191,197,601
E-Class 4dr	17-18	M8x45	2	2		165 lbs./75 kg	2,5,14,50,54,64,81,82,100,109,110,191,601
GLC Coupe 5dr	17-18	M8x40	1	2		165 lbs./75 kg	2,5,14,49,54,64,69,81,82,100,109,110,132,187,191
R-Class 5dr	06-12	M8x40	1	1		165 lbs./75 kg	2,5,14,49,54,64,81,82,109,110,140,187,191,197,601



# LANDING PAD 11 FIT NOTES

Lea las notas  
que se aplican  
a su vehículo.  
(Páginas 25-33)

		MATERIAL/LARGO	CANT. ARANDELAS ADEL.	CANT. ARANDELAS ATRAS	ESPACIADOR M6 REQUERIDO	PESO MÁXIMO	
<b>MERCEDES</b>							
S-Class 4dr	07-13	M6x40	1	1		165 lbs./75 kg	2,5,14,49,54,64,81,82,100,109,110,187,191,197,601
<b>MITSUBISHI</b>							
Lancer Sportback 5dr	10-14	M6x40	1	1		165 lbs./75 kg	1,2,5,14,47,64,69,81,82,109,110,132,144,187,191,197,601
Outlander 5dr	10-13	M6x40	1	1		165 lbs./75 kg	1,2,5,14,47,54,64,69,81,82,100,109,110,132,187,191,197,601
Outlander 5dr	16-19	M6x40	1	1		165 lbs./75 kg	1,2,5,14,47,64,69,81,82,109,110,132,187,191,601
Outlander Sport 5dr	11-15	M6x40	1	1		165 lbs./75 kg	1,2,5,14,47,54,64,69,81,82,100,109,110,132,187,191,197,601
Outlander Sport 5dr	16-19	M6x40	1	1		165 lbs./75 kg	1,2,5,14,47,64,69,81,82,100,109,110,132,187,191,601
RVR 5dr	10-13	M6x40	1	1		165 lbs./75 kg	1,2,5,14,47,54,64,69,81,82,109,110,132,187,191,197,601
<b>NISSAN</b>							
NV200 5dr	13-19	M8x40	1	1		165 lbs./75 kg	2,5,14,18,49,51,64,81,84,85,86,100,104,109,110,164,165,191,197,601
<b>PORSCHE</b>							
911 2dr	05-12	M6x50	1	1		165 lbs./75 kg	2,14,48,54,64,81,82,100,110,187,601
Cayman 3dr	07-12	M6x50	1	1		125lbs./57 kg	2,14,48,54,64,81,82,110,187,601
Panamera 5dr	10-16	M6x50	1	1		165 lbs./75 kg	2,5,14,48,54,64,69,81,82,109,110,132,191,194,197,601
<b>RAM</b>							
Promaster City Dual sliding drs	15-19	M6x40	1	1		165 lbs./75 kg	2,5,14,47,64,81,82,98,100,104,109,110,132,191,601
<b>SAAB</b>							
9-3 Wagon	06-12	M6x50	1	1		165 lbs./75 kg	1,2,5,14,48,54,64,69,81,82,100,109,110,140,187,191,197,601
<b>SATURN</b>							
Astra 3dr	08-09	M6x40	1	1		165 lbs./75 kg	1,2,5,14,47,54,64,69,81,82,100,109,110,140,187,191,197,601
Astra 5dr	08-09	M6x40	1	1		165 lbs./75 kg	1,2,5,14,47,54,64,69,81,82,100,109,110,140,187,191,197,601
<b>SUBARU</b>							
Forester 5dr	11-11	M6x40	1	1		165 lbs./75 kg	1,2,5,14,47,54,64,69,81,82,109,110,132,187,191,197,601
Forester 5dr	09-13	M6x40	1	1		165 lbs./75 kg	1,2,5,14,47,54,64,69,81,82,100,109,110,132,187,191,197
Forester 5dr	14-18	M6x40	1	1		165 lbs./75 kg	2,5,14,47,54,64,69,81,82,109,110,132,164,191,197,601
Impreza 4dr	08-11	M6x40	1	1		165 lbs./75 kg	2,5,14,47,54,64,81,82,100,109,110,187,191,197
Impreza 4dr	17-19	M6x40	1	1		165 lbs./75 kg	2,5,14,47,54,64,81,82,100,104,109,110,191,601
Impreza 5dr	12-16	M6x40	1	1		165 lbs./75 kg	2,5,14,47,54,64,69,81,82,100,109,110,140,187,191,197,601



# LANDING PAD 11 FIT NOTES

Lea las notas  
que se aplican  
a su vehículo.  
(Páginas 25-33)



		MATERIAL/LARGO	CANT. ARANDELAS ADEL.	CANT. ARANDELAS ATRAS	ESPACIADOR M6 REQUERIDO	PESO MÁXIMO	
<b>SUBARU</b>							
Impreza 5dr	08-11	M6x40	1	1		165 lbs./75 kg	2,5,14,47,54,64,69,81,82,109,110,140,187,191,197
Impreza 5dr	17-19	M6x40	1	1		165 lbs./75 kg	2,5,14,47,54,64,81,82,100,109,110,132,187,191,601
Impreza WRX/STI 4dr	08-11	M6x40	1	1		165 lbs./75 kg	2,5,14,47,54,64,81,82,109,110,187,191,197,601
Impreza WRX/STI 5dr	08-14	M6x40	1	1		165 lbs./75 kg	2,5,14,47,54,64,81,82,100,109,110,187,191,197,601
Impreza WRX/STI 5dr	08-14	M6x40	1	1		165 lbs./75 kg	2,5,14,47,54,64,69,81,82,100,109,110,140,187,191,197,601
Outback Sport 5dr	08-11	M6x40	1	1		165 lbs./75 kg	2,5,14,47,54,64,69,81,82,100,109,110,140,187,191,197
Tribeca 5dr	06-07	M6x40	1	1		165 lbs./75 kg	2,5,14,18,47,54,64,69,81,84,85,86,100,109,110,140,164,165,191,197,601
Tribeca 5dr	08-14	M6x40	1	1		165 lbs./75 kg	2,5,14,18,47,54,64,69,81,84,85,86,100,109,110,140,164,165,191,197,601
WRX/STI 4dr	18-19	M6x40	1	1		165 lbs./75 kg	2,5,11,14,47,64,81,82,104,109,110,132,187,191
<b>SUZUKI</b>							
Kizashi 4dr	10-13	M6x40	1	1		165 lbs./75 kg	2,5,14,47,64,81,82,100,109,110,164,191,197,601
<b>TESLA</b>							
Model S w/ Panoramic Roof 4dr	12-14	M8x40	1	1		165 lbs./75 kg	2,5,14,49,64,81,82,107,109,112,132,164,191,197,601
Model S w/ Panoramic Roof 4dr	15-18	M6x40	1	1		165 lbs./75 kg	2,5,14,47,64,81,82,107,109,112,132,162,164,191,197,601
<b>VOLVO</b>							
V40 5dr	99-04	M6x30	1	1		165 lbs./75 kg	2,5,14,46,54,64,69,81,82,100,104,109,110,132,191,601





**1**

Canoes are limited to 14 ft or less on this application.

Pour cette application, un canot ne doit pas mesurer plus de 4,25 m (14 pi).

Para este uso, las canoas no deben exceder 14 pies de largo.

**2**

HullRaiser and HighRoller require one set of MightyMount 39H (PN 8003539) to be compatible with Yakima CoreBar and JetStream bars.

Pour poser le porte-embarcation HullRaiser et le porte-vélo HighRoller sur les barres CoreBar et JetStream de Yakima, il faut un jeu d'adaptateurs MightyMount 39H (art. n° 8003539).

Para ser compatibles con las barras CoreBar y JetStream de Yakima, el portaembarcación HullRaiser y el portabicicleta HighRoller necesitan un kit MightyMount 39H (pieza nro. 8003539).

**5**

HullyRollers and Mako Saddles require one set of MightyMount 39H (PN 8003539) per pair of saddles or rollers to be compatible with Yakima CoreBar and JetStream bars.

Pour poser les porte-embarcations HullyRollers et Mako Saddles sur les barres CoreBar et JetStream de Yakima, il faut un jeu d'adaptateurs MightyMount 39H (art. n° 8003539) par paire de selles ou de rouleaux.

Para ser compatibles con las barras CoreBar y JetStream de Yakima, los portaembarcaciones HullyRollers y Mako Saddles necesitan un kit MightyMount 39H (pieza nro. 8003539) por par de asientos o rodillos.

**11**

HullyRollers and Mako Saddles each require one set of Universal MightyMounts per pair to be compatible with factory or optional crossbars.

Quand on installe des rouleaux HullyRollers et des selles Mako Saddles sur des barres transversales d'origine ou optionnelles, il faut un ensemble de colliers Universal MightyMount par paire pour assurer la compatibilité.

Quand on installe des rouleaux HullyRollers et des selles Mako Saddles sur des barres transversales d'origine ou optionnelles, il faut un ensemble de colliers Universal MightyMount par paire pour assurer la compatibilité.

**14**

Using Yakima RoundBars with Yakima BaseLine, TimberLine, SkyLine or RidgeLine towers will require the purchase of RoundBar SL Adapter (PN 8003536) sold separately.

Si on emploie les barres rondes Yakima avec les pieds BaseLine, TimberLine, SkyLine ou RidgeLine, il faut acheter les adaptateurs pour barres rondes Yakima SL (art. no 8003536), qui se vendent à part.

Para utilizar las torres BaseLine, TimberLine, SkyLine o RidgeLine de Yakima con las barras redondas de Yakima, es necesario adquirir el adaptador RoundBar SL de Yakima (pieza nro. 8003536) que se vende por separado.



### 18

If Cross bar spread is greater than 36", shorter skis may not fit or take full advantage of security features.

Si la distance entre les barres transversales est supérieure à 91 cm (36 po), il peut ne pas être possible d'installer des skis courts ou de les protéger avec toutes les caractéristiques de sécurité.

Si la separación entre las barras transversales es mayor que 36", es posible que los esquís más cortos no se ajusten correctamente o que las características de seguridad no sean aprovechadas al máximo.

### 39

M7X40 hardware (PN 8880281) required for this application. To order your M7X40 hardware, contact Yakima Customer Service at (888) 925-4621 Monday through Friday, 7:00 AM to 5:00 PM, PST. Please allow 3-5 business days for delivery.

Pour cette application, il faut employer la trousse de quincaillerie M7X40 (article n° 8880281). Pour la commander, appeler le service à la clientèle de Yakima au (888) 925-4621, du lundi au vendredi, entre 7 h et 17 h, heure du Pacifique. Prévoir de 3 à 5 jours ouvrables pour la livraison.

Para este uso se necesitan las piezas M7X40 (PN 8880281). Para encargar esas piezas, póngase en contacto con el Servicio a la clientela de Yakima llamando al (888) 925-4621, de lunes a viernes, de 7:00 a 5:00 P.M., hora del Pacífico. Por favor prevea de 3 a 5 días hábiles para la entrega.

### 40

Attention! M6 Spacer (PN 8880518) hardware required for this application. 2 are included with each pair of Landing Pad 11. If not included, order hardware (bag of 4) by contacting Customer Service at (888) 925-4621 Monday through Friday, 7:00 AM to 5:00 PM, PST. Please allow 3-5 business days for delivery.

Attention ! Pour cette application, il faut employer la trousse de quincaillerie intercalaire M6 (article n° 8880518). Il y en a deux avec chaque paire de Landing Pad 11. Si ce n'est pas le cas, la commander (sac de quatre) en appelant au service à la clientèle de Yakima au (888) 925-4621, du lundi au vendredi, entre 7 h et 17 h, heure du Pacifique. Prévoir de 3 à 5 jours ouvrables pour la livraison.

¡Atención! Para esta aplicación se necesita el espaciador M6 (pieza nro. 8880518). Cada par de Landing Pad 11 incluye 2 espaciadores. Si no están incluidos, puede encargarlos (bolsa de 4) llamando al (888) 925-4621 del Servicio a la clientela, de lunes a viernes, de 7:00 a 5:00 P.M., hora del Pacífico. Por favor prevea de 3 a 5 días hábiles para la entrega.

### 41

Attention! 4 washers per bolt are required for this application. 8 are included with each pair of Landing Pad 11. If not included, contact Customer Service at (888) 925-4621 Monday through Friday, 7:00 AM to 5:00 PM, PST. Please allow 3-5 business days for delivery.

Attention ! Pour cette application, il faut employer quatre rondelles par boulon. Il y en a huit avec chaque paire de Landing Pad 11. Si ce n'est pas le cas, appeler au service à la clientèle de Yakima au (888) 925-4621, du lundi au vendredi, entre 7 h et 17 h, heure du Pacifique. Prévoir de 3 à 5 jours ouvrables pour la livraison.

¡Atención! Para esta aplicación se necesitan 4 arandelas metálicas por tornillo. Cada par de Landing Pad 11 incluye 8 arandelas. Si no están incluidas, llame al (888) 925-4621 del Servicio a la clientela, de lunes a viernes, de 7:00 a 5:00 P.M., hora del Pacífico. Por favor prevea de 3 a 5 días hábiles para la entrega.



### 46

Use M6x30 mounting hardware for this application.

Pour cette application, employer la quincaillerie de montage M6x30.

Utilice la pieza de fijación M6x30 para esta aplicación.

### 47

Use M6x40 mounting hardware for this application.

Pour cette application, employer la quincaillerie de montage M6x40.

Utilice la pieza de fijación M6x40 para esta aplicación.

### 48

Use M6x50 mounting hardware for this application.

Pour cette application, employer la quincaillerie de montage M6x50.

Utilice la pieza de fijación M6x50 para esta aplicación.

### 49

Use M8x40 mounting hardware for this application.

Pour cette application, employer la quincaillerie de montage M8x40.

Utilice la pieza de fijación M8x40 para esta aplicación.

### 50

Use M8x45 mounting hardware for this application.

Pour cette application, employer la quincaillerie de montage M8x45.

Utilice la pieza de fijación M8x45 para esta aplicación.

### 51

Vehicle has more than four mounting point locations which can produce different crossbar spreads. Consult crossbar spread table for the accessory you wish to carry and choose Landing Pad locations accordingly. Reference Landing Pad 11 instructions, Fit list, or Yakima.com for crossbar spread tables.

Le véhicule a plus de quatre points de montage, ce qui peut donner plusieurs distances entre les barres transversales. Consulter le tableau "Distance entre les barres transversales" en fonction de l'accessoire à installer, ce qui permettra de choisir l'emplacement des Landing Pad. Consulter les instructions des Landing Pad, la liste de compatibilité (Fit List) ou Yakima.com.

El vehículo tiene más de cuatro puntos de fijación que pueden crear separaciones diferentes entre las barras transversales. Consulte la Tabla de separación de las barras transversales para el accesorio que usted desea cargar y determine en consecuencia la posición adecuada de las Landing Pad. Consulte las instrucciones del Landing Pad 11, la lista de compatibilidad, o Yakima.com para acceder a dicha tabla.



## 52

The mounting points on this vehicle are located under ditch molding or plugs on the roof. Removal and/or permanent modification may be required for this fit. Most body shops or rack install shops are qualified to do the installation.

Sur ce véhicule, les points de montage se trouvent sous des moulures ou des caches sur le toit. Cette installation peut exiger leur enlèvement ou des modifications permanentes. La plupart des ateliers de carrosserie ou d'installation de porte-bagages peuvent effectuer l'installation.

Los puntos de fijación de este vehículo están situados debajo del reborde de goma o de los tapones del techo. Es posible que para una instalación adecuada se deban retirar o modificar de forma permanente. La mayoría de los talleres de carrocería o de instalación de racks están calificados para hacer la instalación.

## 61

The roof, rubber/chrome door seals and/or trim may deform or be damaged under prolonged contact with any roof rack towers and/or clips. Do not over-tighten or overload the rack. Remove rack when not in use.

À la longue, les joints et garnitures en caoutchouc ou chromés de portières ou de toit peuvent se déformer ou s'endommager au contact de tout crochet ou pied de porte-bagages. Ne pas trop serrer le porte-bagage et ne pas le surcharger. Enlever le porte-bagage quand il ne sert pas.

El techo, los burletes y rebordes de caucho o cromo de las puertas pueden deformarse o dañarse por el contacto prolongado con las torres o clips del portaequipaje. No ajuste demasiado ni sobrecargue el portaequipaje. Quite el portaequipaje cuando no lo utilice.

## 54

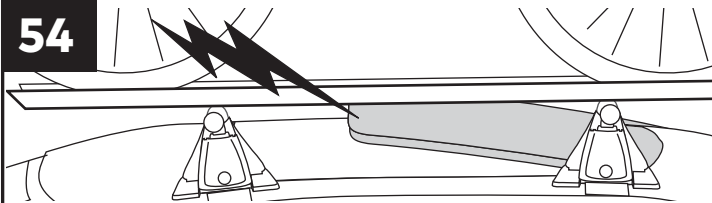

When open, the sunroof may interfere with some accessories.

S'il est ouvert, le panneau de toit risque d'entrer en contact avec les accessoires.

El techo corredizo abierto puede interferir con los accesorios.

## 64

**CAUTION!** Do not over tighten Landing Pad hardware. Pad should be snug against the roof with no movement.

**ATTENTION !** Ne pas trop serrer la quincaillerie du Landing Pad. Le patin doit être bien appuyé contre le toit et ne pas bouger.

**¡PRECAUCIÓN!** No aprieta excesivamente las piezas de fijación del Landing Pad. La almohadilla debe quedar ligeramente ajustada e inmóvil contra el techo.



### 69

Refer to current Yakima Fit List or visit <http://www.yakima.com/download/Yakima-Hatch-Interference.pdf> for rear hatch clearance information regarding cargo boxes.

Pour plus de détails sur les possibilités de contact entre le hayon et la caisse, consulter la liste de compatibilité (Fit List) la plus récente ou le site <http://www.yakima.com/download/Yakima-Hatch-Interference.pdf>.

Consulte la Lista de compatibilidad actual de Yakima o visite <http://www.yakima.com/download/Yakima-Hatch-Interference.pdf> para obtener información sobre la separación entre la portezuela trasera y las cajas de equipaje.

### 81

All loads extending beyond the length of the roof (except cargo boxes) must be secured to both the front and rear of the vehicle, in addition to the rack.

Toutes les charges qui dépassent la longueur du toit (sauf une caisse de transport) doivent être arrimées à l'avant et à l'arrière du véhicule, en plus du porte-bagage.

Todas las cargas que superan el largo del techo (excepto las cajas para equipaje) deben amarrarse a las partes delantera y trasera del vehículo, así como al portaequipaje.

### 84

SideWinder (Tandem Bike Mount) will not work due to crossbar spread limitations.

Le SideWinder (porte-vélo pour tandem) n'est pas compatible parce que la distance entre les barres transversales est limitée.

El portabicileta SideWinder (para bicicletas en tándem) no es compatible debido a que la separación entre las barras transversales es limitada.

### 82

SideWinder (Tandem Bike Mount) is compatible with Yakima RoundBar only.

Le SideWinder (porte-vélo pour tandem) n'est compatible qu'avec les barres rondes RoundBar de Yakima.

El SideWinder (para bicicletas en tándem) es compatible solamente con las barras RoundBars de Yakima.

### 85

Raptor and Raptor Aero, will not work due to crossbar spread limitations.

Le Raptor et le Raptor Aero ne peuvent pas être installés à cause de la limitation de distance entre les barres transversales.

Los portabiciquetas Raptor y Raptor Aero, no son compatibles debido a las limitaciones de la separación entre las barras transversales.

### 86

HighSpeed and HighRoad will not work on this application due to crossbar spread or other limitations.

Le HighSpeed et le HighRoad ne peuvent pas être installés à cause de la limitation de distance entre les barres transversales et d'autres facteurs.

Los portabiciquetas HighSpeed y HighRoad no son compatibles debido a la separación entre las barras transversales u otras limitaciones.



### 88

ForkChop is the only bike carrier that fits this application due to crossbar spread limitations.

Le ForkChop est le seul porte-vélo qui s'adapte à cette application à cause de la limitation de distance entre les barres transversales.

El ForkChop es el único portabicicletas compatible con esta aplicación debido a las limitaciones de la separación entre las barras transversales.

### 98

ShowDown requires crossbars one size larger than the recommended minimum for adequate vehicle side clearance on this application.

Pour cette application, il faut que le ShowDown soit monté sur des barres transversales une taille plus longue que le minimum recommandé pour avoir assez de dégagement avec le côté du véhicule.

Para este uso, el ShowDown requiere barras transversales más largas que el mínimo recomendado para lograr una separación lateral adecuada del vehículo.

### 100

ShowDown may require crossbars larger than the recommended minimum due to vehicle side clearance requirements.

Avec le ShowDown, il faudra peut-être des barres transversales plus longues que le minimum recommandé pour avoir assez de dégagement avec le côté du véhicule.

El soporte ShowDown puede necesitar barras transversales más largas que el mínimo recomendado debido a los requerimientos de separación lateral con respecto al vehículo.

### 104

If crossbar spread is between 24" and 29", length of canoe must be 14' or less.

Si la distance entre les barres est de 61 à 74 cm (24 à 29 po), le canot ne doit pas mesurer plus de 4,25 m (14 pi).

Si la separación entre las barras transversales está comprendida entre 24" y 29", el largo de la embarcación debe ser 14' o menos.

### 107

ShowCase 15 will not fit if crossbar spread is greater than 34".

Le ShowCase 15 ne peut pas être installé si la distance entre les barres transversales est supérieure à 86 cm (34 po).

La caja ShowCase 15 no es compatible si la separación entre las barras transversales es mayor que 34".

### 109

Always be sure to tie down your SUP as per instructions. SupPup and SupDawg require using nose tie down strap.

Une planche à rame doit toujours être arrimée selon les instructions. Avec les porte-planches SupPup et SupDawg, il faut employer la sangle d'arrimage avant.

Asegúrese siempre de atar la tabla SUP respetando las instrucciones. Con los soportes SupPup y SupDawg se debe usar la correa para atar el extremo delantero.



## 110

If your vehicle is equipped with a sunroof or panoramic glass roof, prior to operation, ensure adequate clearance exists with roof rack and/or accessories installed.

Si le véhicule est équipé d'un toit ouvrant ou d'une fenêtre de toit panoramique, vérifier avant de les faire fonctionner qu'ils disposent d'assez de dégagement par rapport au porte-bagage et/ou aux accessoires installés sur le toit.

Si su vehículo cuenta con un techo de vidrio corredizo o panorámico, antes de abrirlo asegúrese de que haya una separación adecuada con respecto a los racks y/o accesorios de techo instalados.

## 112

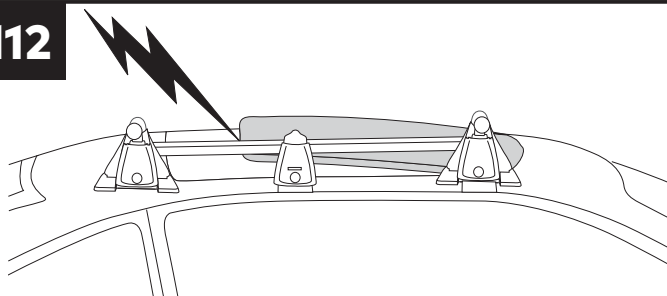

The sunroof/panoramic roof should not be opened while the rack and/or gear mounts are installed. You may remove the rack when not in use.

On ne devrait pas ouvrir le toit ouvrant si le porte-bagage ou le porte-accessoire est en place. On peut enlever le porte-bagage quand il ne sert pas.

El techo corredizo no debe estar abierto cuando el vehículo tiene instalado un rack o una caja para equipaje. Si no utiliza estos accesorios, sáquelos.

## 113

This application is not recommended for vehicles with panoramic sunroofs.

Cette application n'est pas recommandée pour les véhicules avec toit ouvrant panoramique.

Esta aplicación no se recomienda para vehículos con techo solar panorámico.

## 132

Any load/mount extending beyond the rear hatch seam may cause interference.

Une charge ou un accessoire qui dépasserait au-delà du joint du hayon pourrait gêner.

Toda carga o montaje que se extienda más allá del borde de la portezuela trasera puede causar interferencia.

## 140

Load/Mount will prevent rear hatch from opening fully. Use caution to prevent damage.

La charge ou l'accessoire empêcheront d'ouvrir le hayon complètement : l'ouvrir avec prudence pour prévenir des dommages.

La carga/montaje impedirá que la portezuela trasera se abra completamente. Tenga cuidado para evitar posibles daños.



### 143

Crossbar spread is fixed.

La distance entre les barres transversales est fixe.

La separación de las barras transversales es fija.

### 144

Roof mounted antenna may need to be removed to prevent interference with long loads, boxes.

Si l'on transporte des charges longues, il faudra peut-être enlever l'antenne montée sur le toit.

Si carga objetos largos o cajas de equipaje, puede que sea necesario desmontar la antena instalada en el techo.

### 162

For Tesla Model S manufactured from 1/2012 - 5/2015 use M8x40 hardware. For Model S manufactured from 6/2015+ use M6x40 hardware.

Pour les Tesla modèle S fabriquées entre janvier 2012 et mai 2015, utiliser la quincaillerie M8x40. Pour les modèles S fabriqués à partir de juin 2015, utiliser la quincaillerie M6x40.

Para el Tesla modelo S fabricado entre 1/2012 - 5/2015 utilice la pieza M8x40. Para el modelo S fabricado a partir de 6/2015 o posterior, utilice la pieza M6x40.

### 164

LoadWarrior requires an extension (Part# 8007074) to fit your vehicle.

Pour monter le LoadWarrior sur ce véhicule, il faut employer une rallonge (art. no 8007074).

La cesta LoadWarrior necesita una extensión (PN 8007074) para que sea compatible con su vehículo.

### 165

MegaWarrior requires an extension (Part# 8007082) to fit your vehicle.

Pour monter le MegaWarrior sur ce véhicule, il faut employer une rallonge (art. no 8007082).

La cesta MegaWarrior requiere una extensión (PN 8007082) para que sea compatible con su vehículo.

### 187

Boa and ForkChop bike mounts will not work on this application due to crossbar spread limitations.

Les porte-vélos Boa et ForkChop ne peuvent pas être installés à cause de la limitation de distance entre les barres transversales.

Los portabicicletas Boa y ForkChop no son compatibles debido a las limitaciones de la separación entre las barras transversales.





### 191

Limited to 2 surf/sail/ paddle boards. Boards must be stacked - NEVER carry side-by-side.

Limité à deux planches à voile, à rame ou de surf. Les planches doivent être posées l'une sur l'autre : ne JAMAIS les transporter côte à côte.

Limitado a 2 tablas de surf/vela/braceo. Las tablas se deben apilar. NUNCA las cargue una al lado de la otra.

### 194

Use the appropriate wrench to remove threaded plugs.

Employer la clé appropriée pour enlever les bouchons vissés.

Utilice la llave apropiada para sacar los tapones roscados.

### 197

Foam blocks limit capacity to one boat per vehicle.

Avec les blocs de mousse, la capacité est limitée à une embarcation par véhicule.

Los bloques de goma espuma limitan la capacidad a una embarcación por vehículo.

### 601

Your vehicle has the potential to accept Yakima SkyRise Small and Medium Rooftop tents but has not been evaluated by the Yakima Fit Team. Please check online at [fit.lookup.yakima.com](http://fit.lookup.yakima.com) for the most up to date information. Please see [Yakima.com](http://Yakima.com) for our user guidelines.

Il est possible que le véhicule accepte les tentes de toit Yakima SkyRise petite et moyenne, mais il n'a pas été évalué par l'équipe Yakima. Prière de consulter le site [fit.lookup.yakima.com](http://fit.lookup.yakima.com) pour les informations les récentes. On trouvera des conseils d'utilisation sur le site [Yakima.com](http://Yakima.com).

Es posible que en su vehículo se puedan cargar las carpas SkyRise Small/Medium de Yakima, pero esto no ha sido evaluado por el equipo de compatibilidad de Yakima. Por favor, visite [fit.lookup.yakima.com](http://fit.lookup.yakima.com) para obtener información más actualizada. Por favor, visite [Yakima.com](http://Yakima.com) para consultar nuestras directivas para el usuario.

**LIMITS (FIT GUIDLINES) CAN'T FIND YOUR CAR?** Go to [yakimatech.com](http://yakimatech.com) to consult our vehicle finder OR call Yakima customer service at: 888-925-4621

### QUICK REFERENCE: Maximum Crossbar Spreads

crossbar spread range...	can carry...	on these mounts...
12-36"	Skis/Snowboards	Any Yakima ski mount
16-38"	Bicycles 1-2	Raptor / Raptor Aero
16-42"	Bicycles 1-2	ForkLift / CopperHead / Viper
16-46"	Bicycles 1-2	SprocketRocket / HighRoller
16-48"	Bicycles 1-2	FrontLoader
18-36"	Bicycles	HighSpeed / HighRoad
18-38"	Bicycles, more than 2	Raptor / Raptor Aero
18-42"	Bicycles, more than 2	ForkLift / CopperHead / Viper
18-46"	Bicycles, more than 2	SprocketRocket / HighRoller
18-48"	Bicycles, more than 2	Frontloader
32-50"	Bicycles	Boa / ForkChop
24-36"	Tandem bicycles	SideWinder
24" or more	Surf/sail/paddle boards	SupPup / SupDawg
24" or more	Kayaks	DeckHand / HandRoll / SweetRoll / EvenKeel / Mako Saddles HullyRollers / LandShark / HullHound / JayLow / JayHook BowDown / HullRaiser Aero / HullRaiser / BigStack / ShowBoat ShowDown
30" or more	Kayaks	KayakStacker + Crossbar pads
24" or more	Canoes (under 14')	KeelOver
30" or more	Canoes (over 14')	KeelOver
24-32"	Cargo	RocketBox Pro 12
24-36"	Cargo	RocketBox 15s / SkyBox 16s / SkyBox Pro 16s
24-40"	Cargo	RocketBox Pro 11/14
24-42"	Cargo	SkyBox 12, 18, 21 / SkyBox Pro 12, 18, 21
30-36"	Cargo	RocketBox 16 / RocketBox 11
12-41"	Cargo	BasketCase
24-32"	Bikes, skis, boats, cargo	Medium Basket
30-50"	Bikes, skis, boats, cargo	Medium Basket with extension
30-38"	Bikes, skis, boats, cargo	Large Basket
36-60"	Bikes, skis, boats, cargo	Large Basket with extension
24-77"	Awning	SlimShady

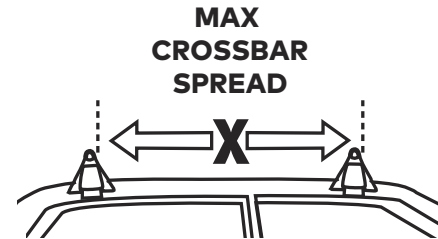

Max crossbar spread refers to the MAXIMUM distance (in inches), between the front and rear crossbars, center to center. Crossbar spread is a key factor in determining the loads that the system can safely carry on a car. The chart at left lists a minimum and maximum spread for what can be carried with the listed mounts.

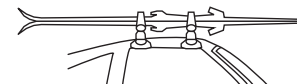

**12" SPREAD (MINIMUM)**

Skis, snowboards, and BasketCase.

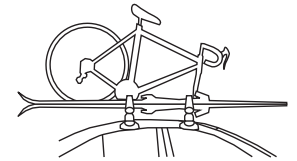

**16" SPREAD (MINIMUM)**

Skis, snowboards, and 2 bikes (30 lb. weight limit per bike.)(Excludes tandems.)

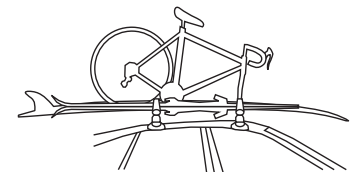

**24" SPREAD (MINIMUM)**

Skis, snowboards, bikes (including tandems), surf/sail/paddle boards, and kayaks.

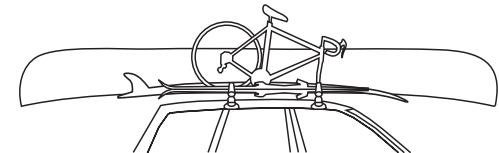

**30" - 36" SPREAD**

Skis, snowboards, bikes (including tandems), surf/sail/paddle boards, kayaks, and canoes.

**Remember to follow weight limits and tie-down long loads.**

More than 2 bicycles create enough leverage on the wheel tray to make the longer crossbar spread necessary.

**NOTE: ANY LOAD EXTENDING OVER THE WINDSHIELD (EXCEPT YAKIMA CARGO BOXES) MUST BE SECURED TO THE FRONT AND REAR OF THE CAR, AND TO THE RACK ITSELF**

**LIMITES (CONSIGNES DE MONTAGE) VOUS NE TROUVEZ PAS VOTRE VOITURE**

Consulter le site yakimatech.com pour voir s'il y figure ou appeler le service à la clientèle de Yakima au (888) 925-4621.

**EN UN COUP D'ŒIL : Distances minimales et maximales entre les barres transversales**

Dist. entre barres transversales...	pour transporter...	sur cet accessoire...
30-91 cm (12-36 po)	Skis/planches à neige	Tout porte-ski Yakima
40-99 cm (16-38 po)	1-2 vélos	Raptor / Raptor Aero
40-107 cm (16-42 po)	1-2 vélos	ForkLift / CopperHead / Viper
40-117 cm (16-46 po)	1-2 vélos	SprocketRocket / HighRoller
40-122 cm (16-48 po)	1-2 vélos	FrontLoader
46-97 cm (18-38 po)	Vélos, plus de 2	Raptor / Raptor Aero
46-91 cm (18-36 po)	Vélos	HighSpeed / HighRoad
46-107 cm (18-42 po)	Vélos, plus de 2	ForkLift / CopperHead / Viper
46-117 cm (18-46 po)	Vélos, plus de 2	SprocketRocket / HighRoller
46-12 cm (18-48 po)	Vélos, plus de 2	Frontloader
81-127 cm (32-50 po)	Vélos	Boa / ForkChop
61-91 cm (24-36 po)	Tandems	SideWinder
61 cm (24 po) ou plus	Planches surf/à voile/à rame	SupPup / SupDawg
61 cm (24 po) ou plus	Kayaks	DeckHand / HandRoll / SweetRoll / EvenKeel Mako SaddlesHullyRollers / LandShark / HullHound JayLow / JayHookBowDown / HullRaiser Aero HullRaiser / BigStack ShowBoat / ShowDown
30" o más	Kayaks	KayakStacker + coussins sur barres
24" o más	Canoas (por debajo de 14')	KeelOver
30" o más	Canoas (por debajo de 14')	KeelOver
24-32"	Equipaje	RocketBox Pro 12
24-36"	Equipaje	RocketBox 15s / SkyBox 16s / SkyBox Pro 16s
24-40"	Equipaje	RocketBox Pro 11/14
24-42"	Equipaje	SkyBox 12, 18, 21 / SkyBox Pro 12, 18, 21
30-36"	Equipaje	RocketBox 16 / RocketBox 11
12-41"	Equipaje	BasketCase
61-81 cm (24-32 po)	Vélos, skis, embarcations, bagages	Panier moyen
76-127 cm (30-50 po)	Vélos, skis, embarcations, bagages	Panier moyen avec rallonge
76-97 cm (30-38 po)	Vélos, skis, embarcations, bagages	Grand panier
91-153 cm (36-60 po)	Vélos, skis, embarcations, bagages	Grand panier avec rallonge
61-196 cm (24-77 po)	Auvent	SlimShady



**DISTANCE MAXI ENTRE LES BARRES**

La distance maximale entre les barres transversales désigne la distance MAXIMALE entre les barres avant et arrière, de centre à centre. Cette distance est un facteur essentiel pour déterminer les charges que le porte-bagage peut transporter de manière sécuritaire sur le véhicule. Le tableau à gauche donne les distances mini et maxi pour ce que l'on peut transporter avec l'accessoire indiqué.

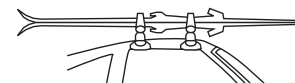

**DISTANCE DE 30 cm/12 po (MINIMUM)**

Des skis, des planches à neige et panier BasketCase.

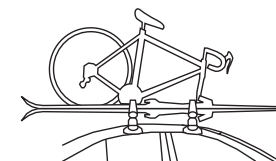

**DISTANCE DE 40 cm/16 po (MINIMUM)**

Des skis, des planches à neige et 2 vélos (ne pesant pas plus de 14 kg/30 lb chacun, tandems exclus).

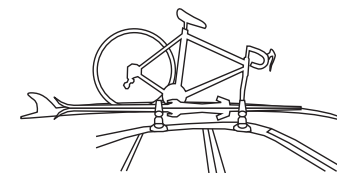

**DISTANCE DE 61 cm/24 po (MINIMUM)**

Des skis, des planches à neige, des vélos (y compris tandems), des planches de surf/à voile/à rame, et des kayaks.

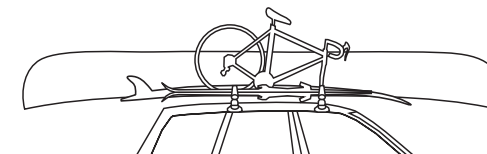

**DISTANCE DE 76 à 91 cm (30 à 36 po)**

Des skis, des planches à neige, des vélos (y compris tandems), des planches de surf/à voile/à rame, des kayaks et des canots.

**Se souvenir de respecter les limites de poids et d'arrimer les charges longues.**

La présence de plus de deux vélos crée des efforts suffisants sur le porte-vélo pour rendre nécessaire l'allongement de la distance entre les barres transversales.

REMARQUE : TOUTE CHARGE QUI DÉPASSE AU-DESSUS DU PARE-BRISE (SAUF UNE CAISSE DE TRANSPORT YAKIMA) DOIT OBLIGATOIREMENT ÊTRE ARRIMÉE À L'AVANT ET À L'ARRIÈRE DU VÉHICULE, EN PLUS DU PORTE-BAGAGE.

**LÍMITES (DIRECTIVAS DE COMPATIBILIDAD) ¿NO PUEDE ENCONTRAR SU VEHÍCULO?**

Visite [yakimatech.com](http://yakimatech.com) para consultar nuestro buscador de vehículos o llame al Servicio a la clientela de Yakima al: 888-925-4621.

**REFERENCIA RÁPIDA: Separaciones máximas y mínimas de las barras transversales**

Separación de las barras transversales...	puede cargar ...	en estos productos de montaje ...
12-36"	Esquí/Tablas de nieve	Todos los portaesquí de Yakima
16-38"	1-2 bicicletas	Raptor / Raptor Aero
16-42"	1-2 bicicletas	ForkLift / CopperHead / Viper
16-46"	1-2 bicicletas	SprocketRocket / HighRoller
16-48"	1-2 bicicletas	FrontLoader
18-38"	Más de 2 bicicletas	Raptor / Raptor Aero
18-36"	Bicicletas	HighSpeed / HighRoad
18-42"	Más de 2 bicicletas	ForkLift / CopperHead / Viper
18-46"	Más de 2 bicicletas	SprocketRocket / HighRoller
18-48"	Más de 2 bicicletas	Frontloader
32-50"	Bicicletas	Boa / ForkChop
24-36"	Bicicletas en tándem	SideWinder
24" o más	Tablas de surf/vela/braceo	SupPup / SupDawg
24" o más	Kayaks	DeckHand / HandRoll / SweetRoll / EvenKeel Mako SaddlesHullyRollers / LandShark / HullHound JayLow / JayHookBowDown / HullRaiser Aero HullRaiser / BigStack ShowBoat / ShowDown
76 cm (30 po) ou plus	Kayaks	KayakStacker + almohadillas de barra transversal
61 cm (24 po) ou plus	Canots (moins de 4,26 m/14 pi)	KeelOver
76 cm (30 po) ou plus	Canots (plus de 4,26 m/14 pi)	KeelOver
61-81 cm (24-32 po)	Bagages	RocketBox Pro 12
61-91 cm (24-36 po)	Bagages	RocketBox 15s / SkyBox 16s / SkyBox Pro 16s
61-102 cm (24-40 po)	Bagages	RocketBox Pro 11/14
61-107 cm (24-42 po)	Bagages	SkyBox 12, 18, 21 / SkyBox Pro 12, 18, 21
76-91 cm (30-36 po)	Bagages	RocketBox 16 / RocketBox 11
12-41"	Equipaje	BasketCase
24-32"	Bicicletas, esquís, embarcaciones, equipaje	Medium Basket
30-50"	Bicicletas, esquís, embarcaciones, equipaje	Medium Basket con extensión
30-38"	Bicicletas, esquís, embarcaciones, equipaje	Large Basket
36-60"	Bicicletas, esquís, embarcaciones, equipaje	Large Basket con extensión
24-77"	Toldo	SlimShady

**SEPARACIÓN MÁXIMA DE LAS BARRAS TRANSVERSALES**

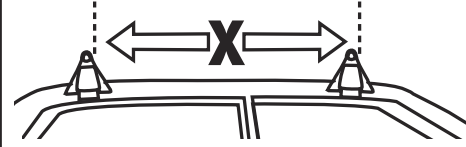

La separación máxima de las barras transversales se refiere a la distancia MÁXIMA (en pulgadas) entre los centros de las barras delantera y trasera. La separación de las barras transversales es un factor clave para determinar las cargas que el sistema puede transportar con seguridad sobre un automóvil. La tabla siguiente lista las separaciones mínima y máxima en función de lo que se puede cargar encima de los productos de montaje listados.

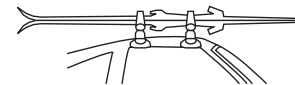

**SEPARACIÓN DE 12" (MÍNIMA)**  
Esquí, tablas de nieve y BasketCase.

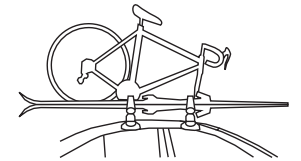

**SEPARACIÓN DE 16" (MÍNIMA)**

Esquí, tablas de nieve y 2 bicicletas (límite de peso de 30 lb por bicicleta, excluidas las en tándem).

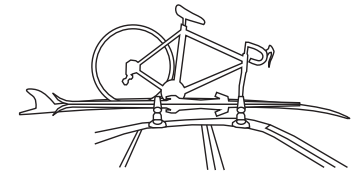

**SEPARACIÓN DE 24" (MÍNIMA)**

Esquí, tablas de nieve, bicicletas (incluidas las en tándem), tablas de surf/vela/braceo y kayaks.

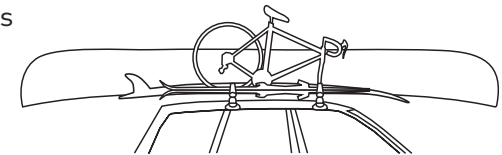

**SEPARACIÓN DE 30" - 36"**

Esquí, tablas de nieve, bicicletas (incluidas las en tándem), tablas de surf/vela/braceo, kayaks y canoas.

**Recuerde que debe respetar los límites de peso y amarrar correctamente las cargas largas.**

Más de 2 bicicletas crean un brazo de palanca en la bandeja de la rueda que obliga a aumentar la separación entre las barras transversales.

**NOTA: LAS CARGAS QUE SOBREPASEN EL PARABRISAS (EXCEPTO LAS CAJAS PARA EQUIPAJE DE YAKIMA) DEBEN AMARRARSE A LAS PARTES DELANTERA Y TRASERA DEL VEHÍCULO, ASÍ COMO AL PORTAEQUIPAJE.**